



# 80x80x38 mm

San Ace 80 9GV type

## General Specifications

- Material ..... Frame: Plastic (Flammability: UL 94V-0), Impeller: Plastic (Flammability: UL 94V-1)
- Expected life ..... See the table below. (L10 life: 90% survival rate for continuous operation in free air at 60°C, rated voltage)  
Expected life at 40°C is for reference only.
- Motor protection function ..... Locked rotor burnout protection, Reverse polarity protection  
For details, please refer to p. 599.
- Dielectric strength ..... 50/60 Hz, 500 VAC, for 1 minute (between lead wire conductors and frame)
- Insulation resistance ..... 10 MΩ or more with a 500 VDC megger (between lead wire conductors and frame)
- Sound pressure level (SPL) ..... At 1 m away from the air inlet
- Storage temperature ..... -30 to +70°C (Non-condensing)
- Lead wire ..... ⊕Red ⊖Black (Sensor) Yellow (Control) Brown
- Mass ..... 220 g

## Specifications

The models listed below **have ribs and pulse sensors with PWM control function**. For models without ribs, append "1" to the end of model numbers.

Model no.	Rated voltage [V]	Operating voltage range [V]	PWM duty cycle* [%]	Rated current [A]	Rated input [W]	Rated speed [min <sup>-1</sup> ]	Max. airflow [m <sup>3</sup> /min] [CFM]	Max. static pressure [Pa] [inchH <sub>2</sub> O]	SPL [dB (A)]	Operating temperature [°C]	Expected life [h]
9GV0812P1G03	12	10.8 to 13.2	100	3.8	45.6	10200	3.9 138.0	490.0 1.97	65	-20 to +70	40000/60°C (70000/40°C)
			0	0.32	3.84	3000	1.15 40.6	42.4 0.17	34		
9GV0812P1H03	12	10.8 to 13.2	100	3.0	36.0	9700	3.7 131.0	440.0 1.77	63		
			0	0.2	2.4	2900	1.11 39.2	39.0 0.16	34		
9GV0812P1F03	12	10.2 to 13.8	100	1.5	18	8000	3.05 108.0	301.0 1.21	58		
			0	0.12	1.44	2400	0.92 32.0	27.1 0.11	26		
9GV0812P1M03	12	10.2 to 13.8	100	0.75	9	6000	2.29 81.0	169.0 0.68	51		
			0	0.09	1.08	1700	0.65 23.0	13.6 0.05	19		
9GV0824P1G03	24	20.4 to 27.6	100	1.6	38.4	10200	3.9 138.0	490.0 1.97	65		
			0	0.3	7.2	4700	1.79 63.2	104.0 0.41	44		
9GV0848P1G03	48	40.8 to 55.2	100	0.84	40.32	10200	3.9 138.0	490.0 1.97	65		
			0	0.15	7.2	4700	1.79 63.2	104.0 0.41	44		

\* PWM input frequency is 25 kHz; models without specifications at 0% PWM duty cycle have zero fan speed at 0%.

Note: Sensor and control options are available for selection. Refer to the table on p. 632.

## Airflow - Static Pressure Characteristics / PWM Duty - Speed Characteristics Example

9GV0812P1G03 With pulse sensor with PWM control function

PWM duty cycle

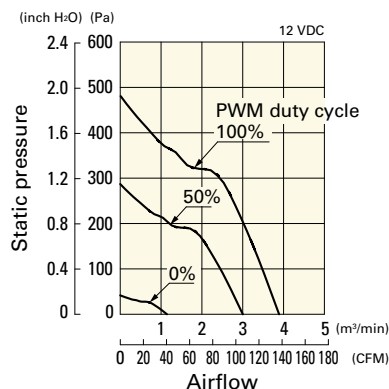

Operating voltage range

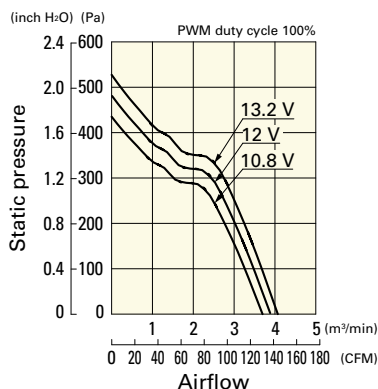

PWM duty - Speed characteristics example

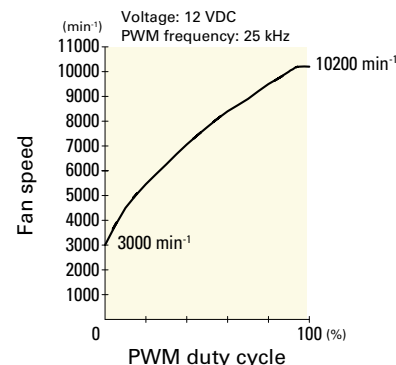

**Airflow - Static Pressure Characteristics / PWM Duty - Speed Characteristics Example**

**9GV0812P1H03** With pulse sensor with PWM control function

PWM duty cycle

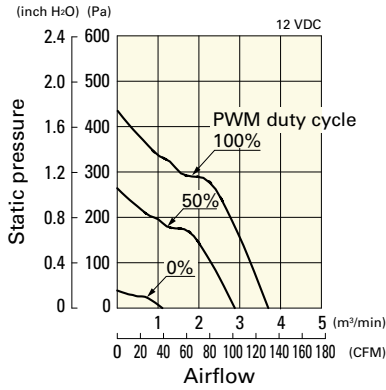

Operating voltage range

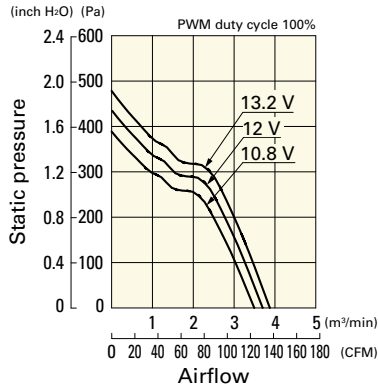

PWM duty - Speed characteristics example

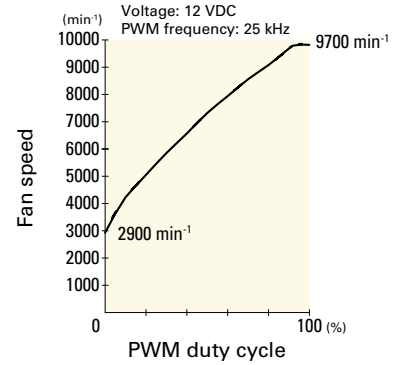

**9GV0812P1F03** With pulse sensor with PWM control function

PWM duty cycle

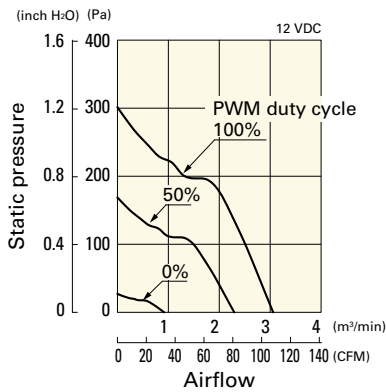

Operating voltage range

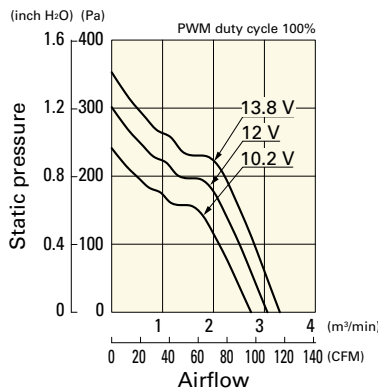

PWM duty - Speed characteristics example

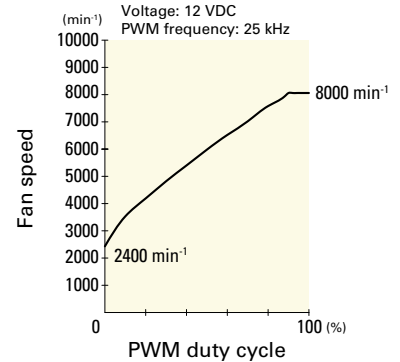

**9GV0812P1M03** With pulse sensor with PWM control function

PWM duty cycle

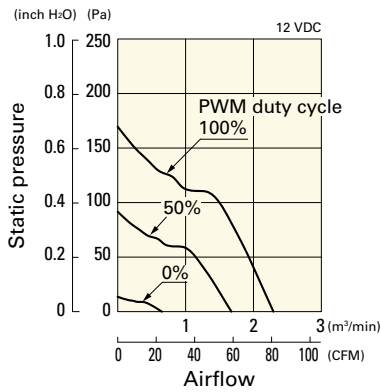

Operating voltage range

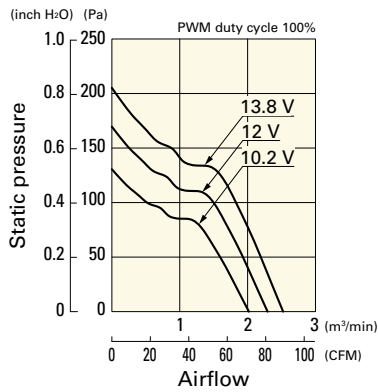

PWM duty - Speed characteristics example

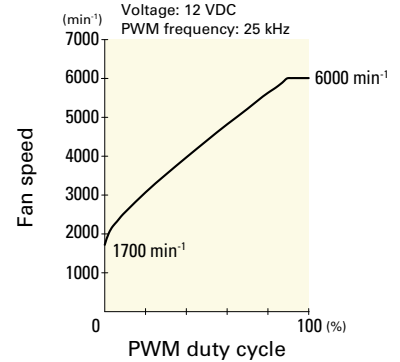

**9GV0824P1G03** With pulse sensor with PWM control function

PWM duty cycle

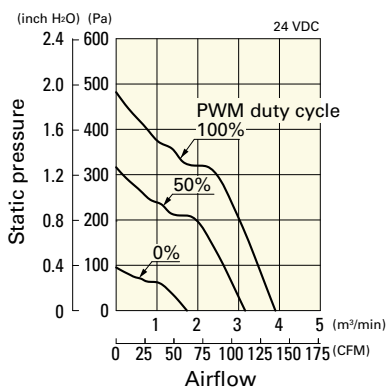

Operating voltage range

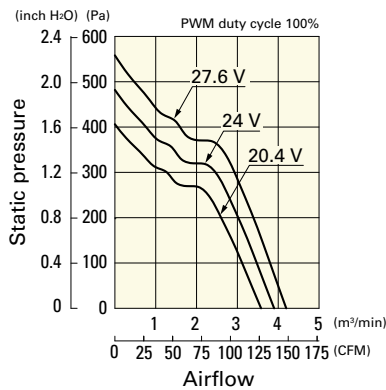

PWM duty - Speed characteristics example

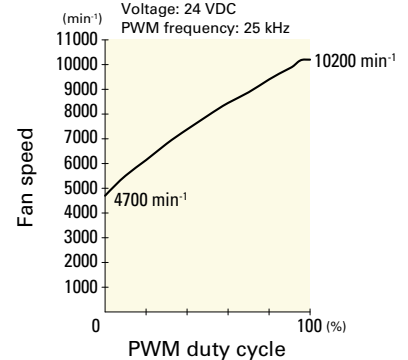

## Airflow - Static Pressure Characteristics / PWM Duty - Speed Characteristics Example

**9GV0848P1G03** With pulse sensor with PWM control function

PWM duty cycle

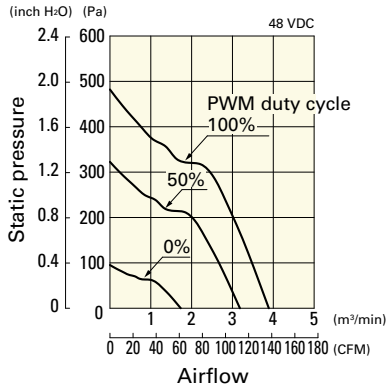

Operating voltage range

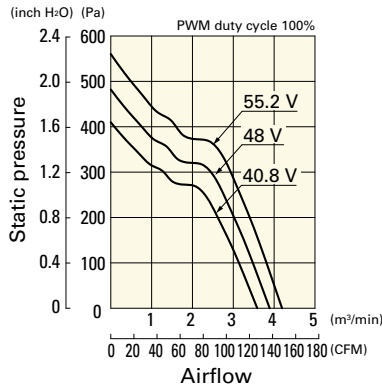

PWM duty - Speed characteristics example

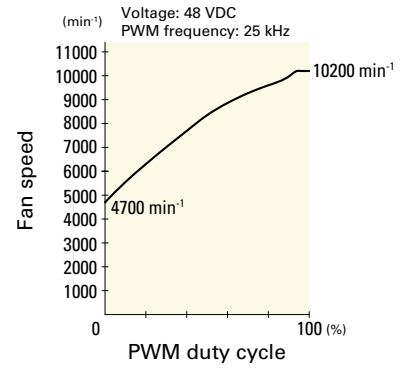

## Dimensions (unit: mm) (With ribs)

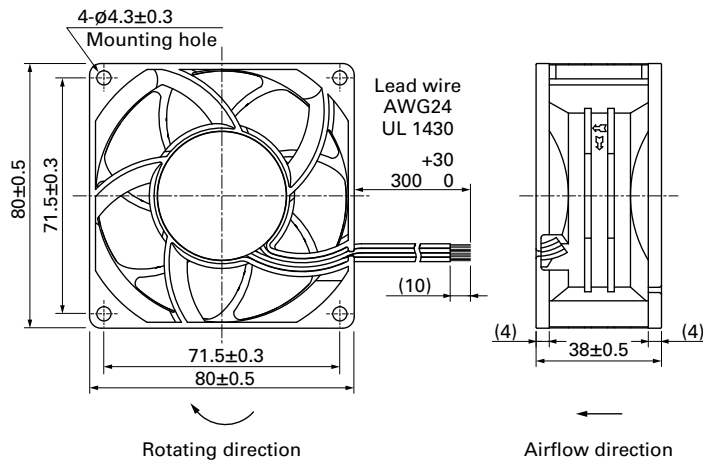

## Reference Dimensions of Mounting Holes and Vent Opening (unit: mm)

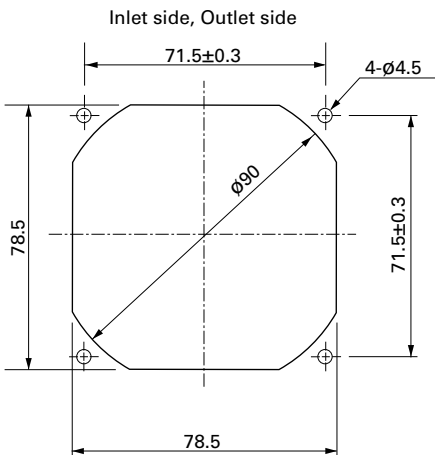

## Options

Finger guards

page: p. 584

Model no.: 109-049E, 109-049H, 109-049C

Resin finger guards

page: p. 591

Model no.: 109-1002G

Resin filter kits

page: p. 592

Model no.: 109-1002F13 (13PPI), 109-1002F20 (20PPI),  
109-1002F30 (30PPI), 109-1002F40 (40PPI)