

ANT-8/9-IPW2-NP 868/915 MHz Outdoor LPWA Antenna

The ANT-8/9-IPW2-NP antenna is an outdoor IP67-rated dipole antenna designed for use in 868 MHz and 915 MHz frequency bands for low-power, wide-area (LPWA) applications such as LoRaWAN®, Sigfox® and WiFi HaLow™ as well as ISM and remote control applications.

The ANT-8/9-IPW2-NP provides a ground plane independent dipole antenna solution which mounts permanently to metallic and non-metallic surfaces. The antenna housing is UV stabilized fiberglass and the antenna connects using an N plug (male pin) connector



Features

- Performance at 862 MHz to 876 MHz
 - VSWR: ≤ 1.9
 - Peak Gain: 0.6 dBi
 - Efficiency: 41%
- Performance at 902 MHz to 930 MHz
 - VSWR: ≤ 1.7
 - Peak Gain: 1.5 dBi
 - Efficiency: 40%
- Enhanced heat and chemical resistant UV stabilized fiberglass antenna housing material
- IP67 rated
- N plug (male pin) connector

Applications

- Low-power, wide-area (LPWA) applications
 - LoRaWAN®, ITU-T Y.4480
 - Sigfox®
 - WiFi HaLow™ (802.11ah)
- Remote control, monitoring and sensing
- Internet of Things (IoT) devices
- ISM applications

Ordering Information

Part Number	Description
ANT-8/9-IPW2-NP	Outdoor LPWA antenna with N plug (male pin) connector

Available from Linx Technologies and select distributors and representatives.

Table 1. Electrical Specifications

ANT-8/9-IPW2-NP	868 MHz	915 MHz
Frequency Range	862 MHz to 876 MHz	902 MHz to 930 MHz
VSWR (max.)	1.9	1.7
Peak Gain (dBi)	0.6	1.5
Average Gain (dBi)	-3.9	-4.0
Efficiency (%)	41	40
Impedance	50 Ω	
Wavelength	1/2-wave	
Electrical Type	Dipole	
Polarization	Linear	
Radiation	Omnidirectional	
Max Power	2 W	

Electrical specifications and plots measured with the antenna in a free space orientation.

Table 2. Mechanical Specifications

Connection	N plug (male pin)
Connector Torque Recommended/Maximum	5 Nm/ 15 Nm
Operating Temperature Range	-40 °C to +70 °C
Ingress Protection Rating (IP)	IP67 rated
Antenna Color	White
Weight	94.2 g (3.32 oz)
Dimensions	132.0 mm x Ø24.0 mm (5.20 in x Ø0.98 in)

Product Dimensions

Figure 1 provides dimensions of the ANT-8/9-IPW2-NP.

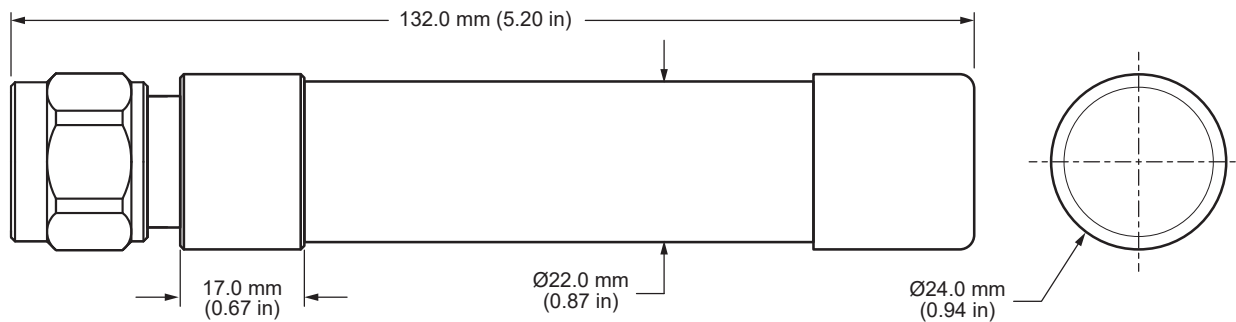

Figure 1. ANT-8/9-IPW2-NP Antenna Dimensions

Packaging Information

The ANT-8/9-IPW2-NP antenna is packaged in a clear plastic bag. Distribution channels may offer alternative packaging options.

LPWA: LoRaWAN® ITU-T Y.4480, and Sigfox®

LoRaWAN and Sigfox LPWA technologies operate within several of the frequencies supported by the 8/9-IPW2-NP antenna. Notably, LoRaWAN operates at the frequency bands shown in Table 3. Sigfox operates at different frequencies determined by country (Table 4).

Table 3. LoRaWAN® Channel plan

Frequency Band	LoRaWAN Channel Plan
779 MHz to 787 MHz	CN779-787
865 MHz to 867 MHz	IN765-867
868 MHz to 873 MHz	EU863-870
902 MHz to 928 MHz	US902-928, AS923
915 MHz to 928 MHz	AU915-928
917 MHz to 923.5 MHz	KR920-923

Table 4. Sigfox® Frequencies by Country/Region

Center Frequency	Select Countries/Regions
868 MHz	Europe
902 MHz	USA, Mexico, Brazil
920 MHz	Australia
923 MHz	Japan

Antenna Orientation

The ANT-8/9-IPW2-NP antenna is characterized in two antenna orientations as shown in Figure 2. The antenna free space orientation characterizes use of an antenna attached to an enclosure-mounted connector which is connected by cable to a printed circuit board. Although the antenna is a dipole not requiring a ground plane for function, characterization at the center of the ground plane (300 mm x 300 mm) provides insight into antenna performance when attached directly to a connector on a metal enclosure. The two orientations represent the most common end-product use cases.

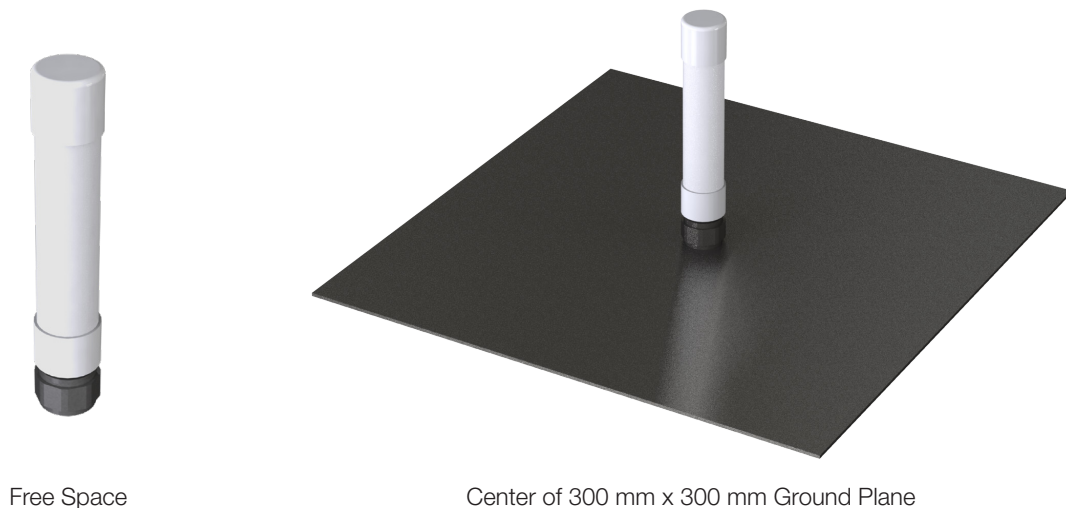

Figure 2. ANT-8/9-IPW2-NP Test Orientations

Free Space, No Ground Plane

The charts on the following pages represent data taken with the antenna oriented in free space as shown in Figure 4.



Figure 4. ANT-8/9-IPW2-NP No Ground Plane (Free Space)

VSWR

Figure 3 provides the voltage standing wave ratio (VSWR) across the antenna bandwidth. VSWR describes the power reflected from the antenna back to the radio. A lower VSWR value indicates better antenna performance at a given frequency. Reflected power is also shown on the right-side vertical axis as a gauge of the percentage of transmitter power reflected back from the antenna.

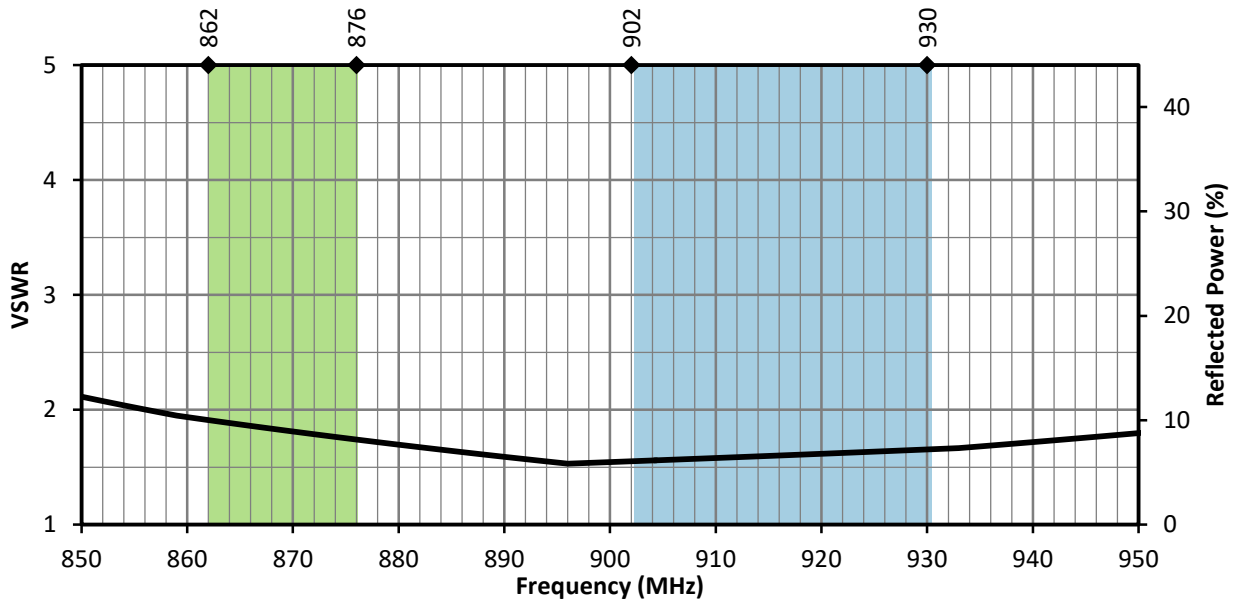

Figure 3. ANT-8/9-IPW2-NP Antenna VSWR, Free Space

Return Loss

Return loss (Figure 6), represents the loss in power at the antenna due to reflected signals. Like VSWR, a lower return loss value indicates better antenna performance at a given frequency.

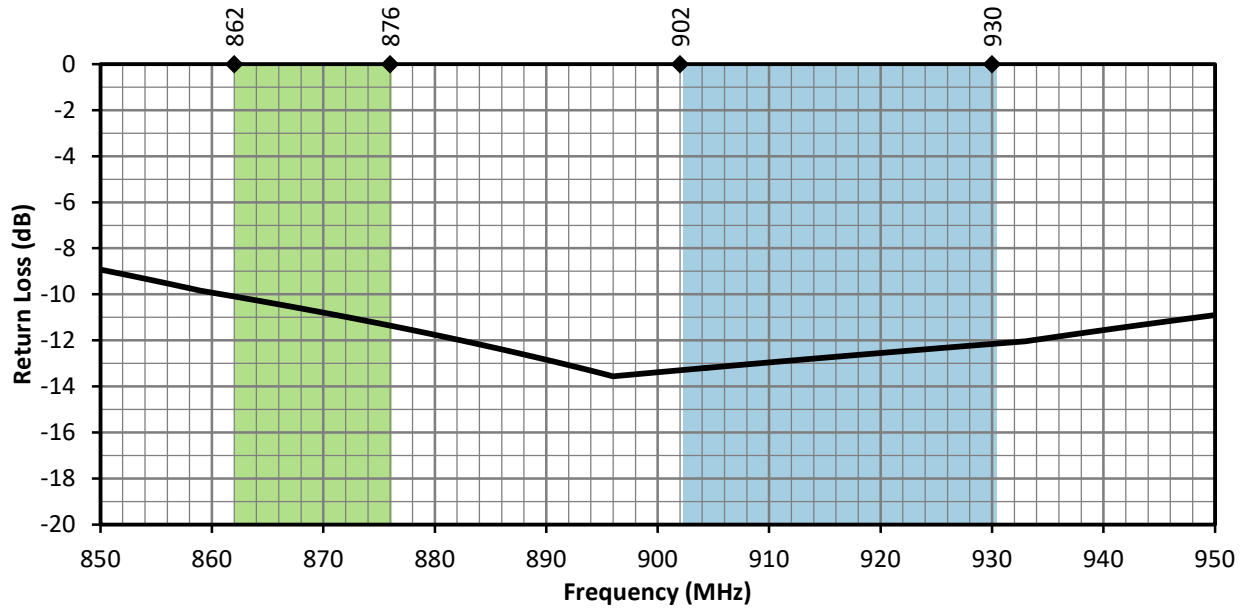

Figure 6. ANT-8/9-IPW2-NP Antenna Return Loss, Free Space

Peak Gain

The peak gain across the antenna bandwidth is shown in Figure 5. Peak gain represents the maximum antenna input power concentration across 3-dimensional space, and therefore peak performance, at a given frequency, but does not consider any directionality in the gain pattern.

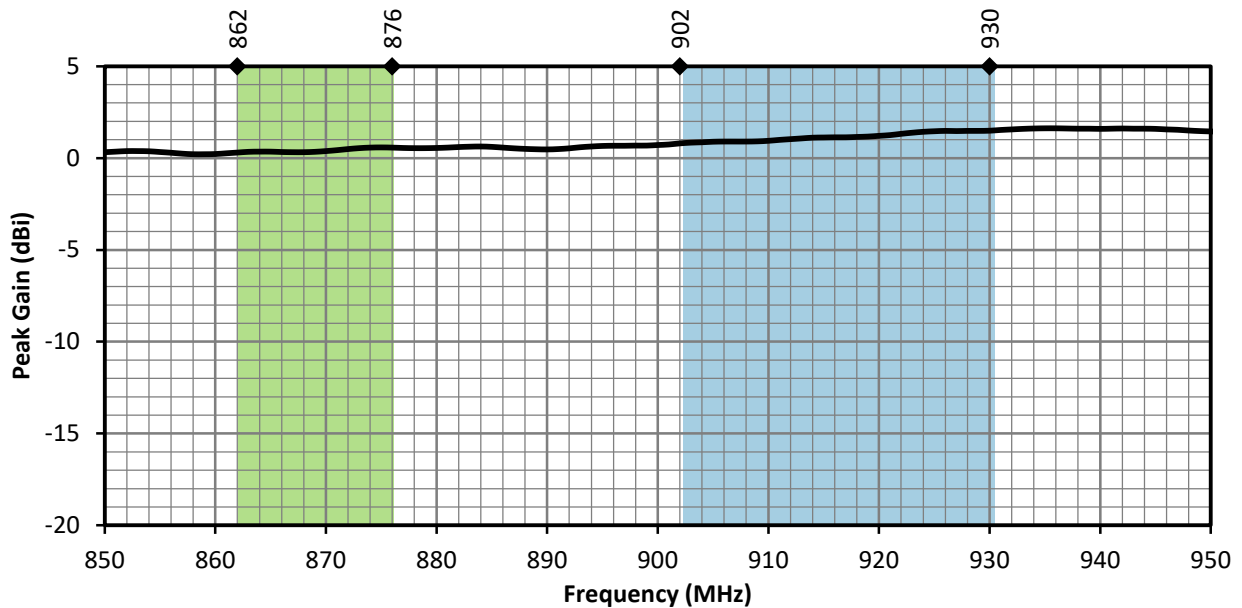

Figure 5. ANT-8/9-IPW2-NP Antenna Peak Gain, Free Space

Average Gain

Average gain (Figure 7), is the average of all antenna gain in 3-dimensional space at each frequency, providing an indication of overall performance without expressing antenna directionality.

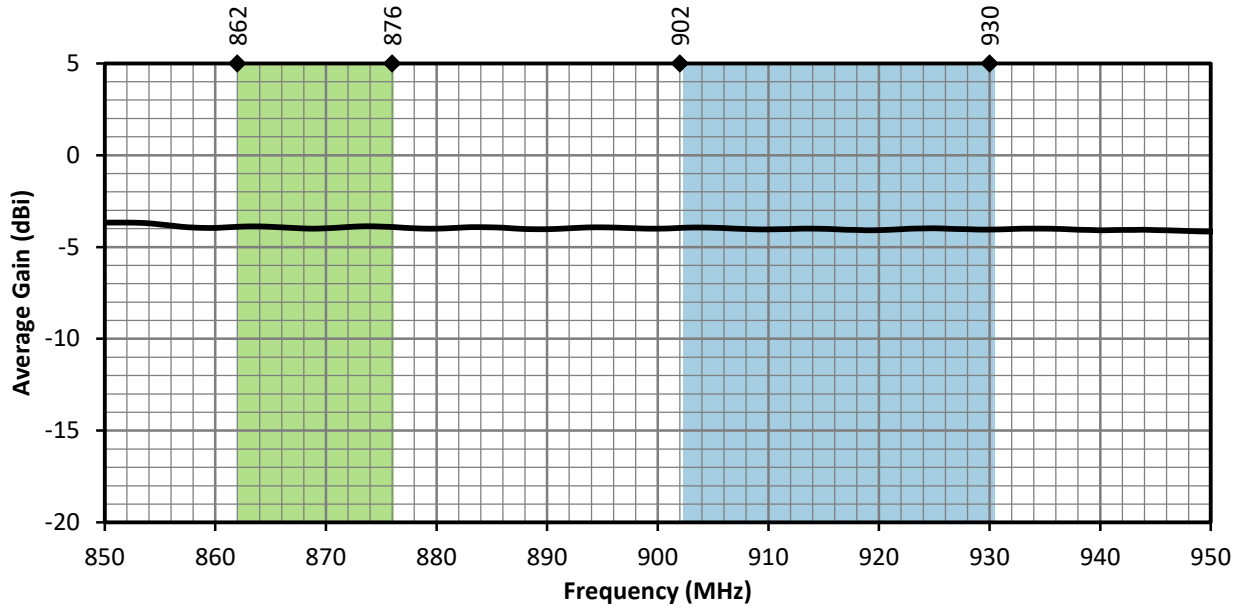

Figure 7. ANT-8/9-IPW2-NP Antenna Average Gain , Free Space

Radiation Efficiency

Radiation efficiency (Figure 8), shows the ratio of power delivered to the antenna relative to the power radiated at the antenna, expressed as a percentage, where a higher percentage indicates better performance at a given frequency.

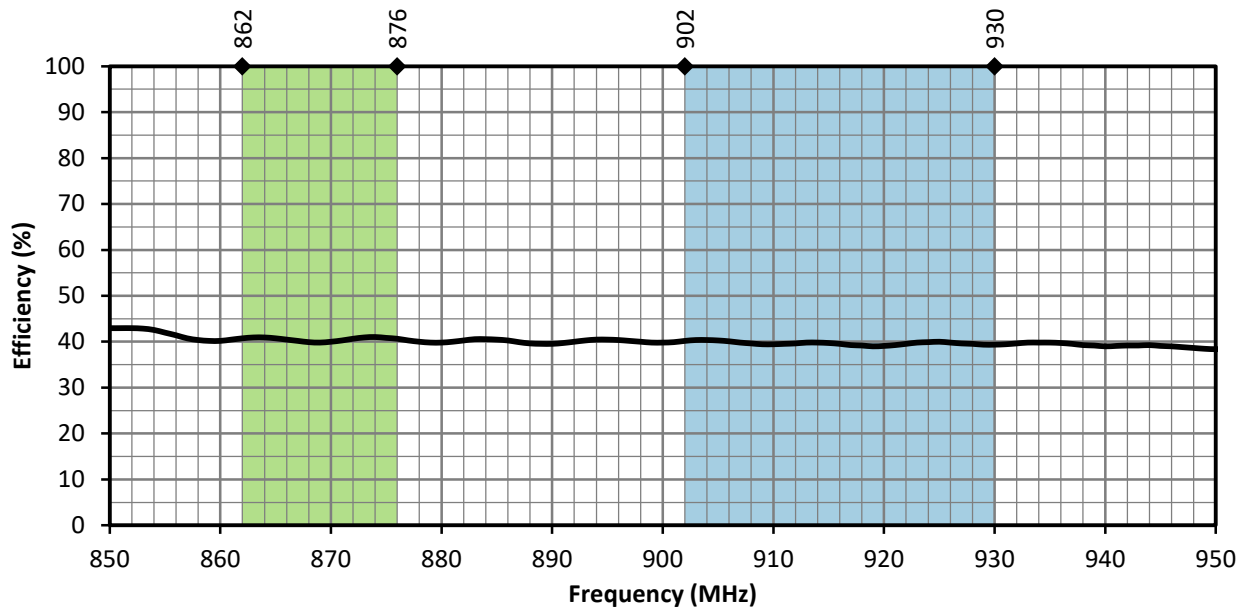

Figure 8. ANT-8/9-IPW2-NP Antenna Radiation Efficiency , Free Space

Radiation Patterns

Radiation patterns provide information about the directionality and 3-dimensional gain performance of the antenna by plotting gain at specific frequencies in three orthogonal planes. Antenna radiation patterns (Figure 9), are shown using polar plots covering 360 degrees. The antenna graphic above the plots provides reference to the plane of the column of plots below it. Note: when viewed with typical PDF viewing software, zooming into radiation patterns is possible to reveal fine detail.

Radiation Patterns - Free Space



862 MHz to 876 MHz (868 MHz)

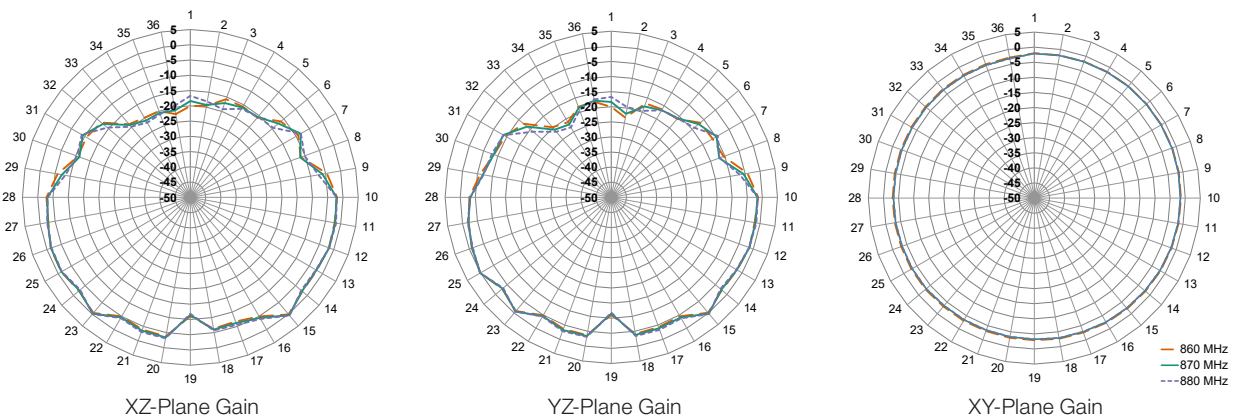

902 MHz to 930 MHz (915 MHz)

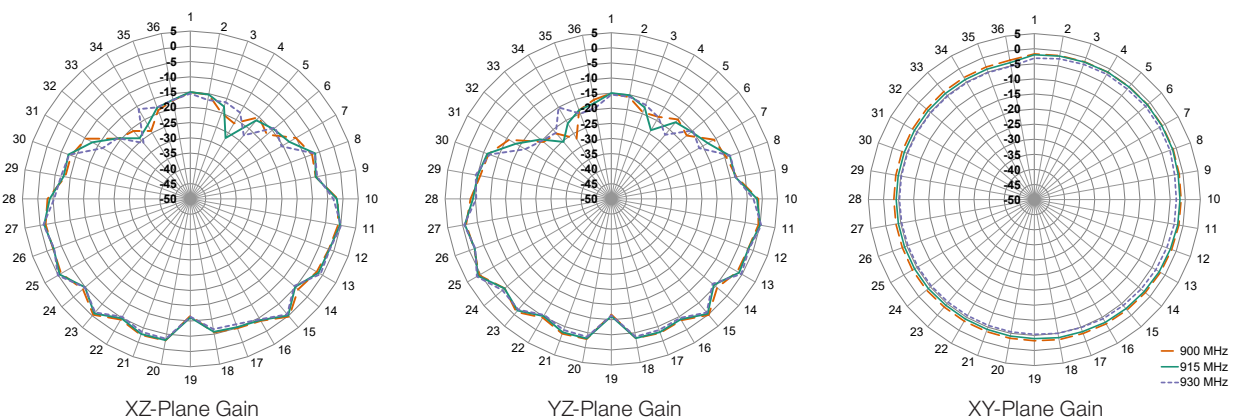

Figure 9. Radiation Patterns for ANT-8/9-IPW2-NP Antenna, Free Space

Center of Ground Plane

The charts on the following pages represent data taken with the antenna oriented at the center of the 300 mm x 300 mm ground plane as shown in Figure 10.

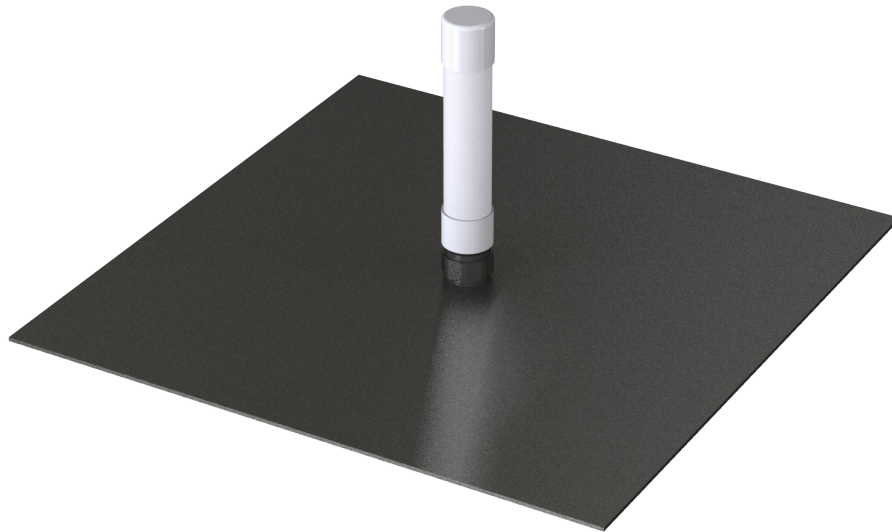

Figure 10. ANT-8/9-IPW2-NP at Center of Ground Plane

VSWR

Figure 11 provides the voltage standing wave ratio (VSWR) across the antenna bandwidth. VSWR describes the power reflected from the antenna back to the radio. A lower VSWR value indicates better antenna performance at a given frequency. Reflected power is also shown on the right-side vertical axis as a gauge of the percentage of transmitter power reflected back from the antenna.

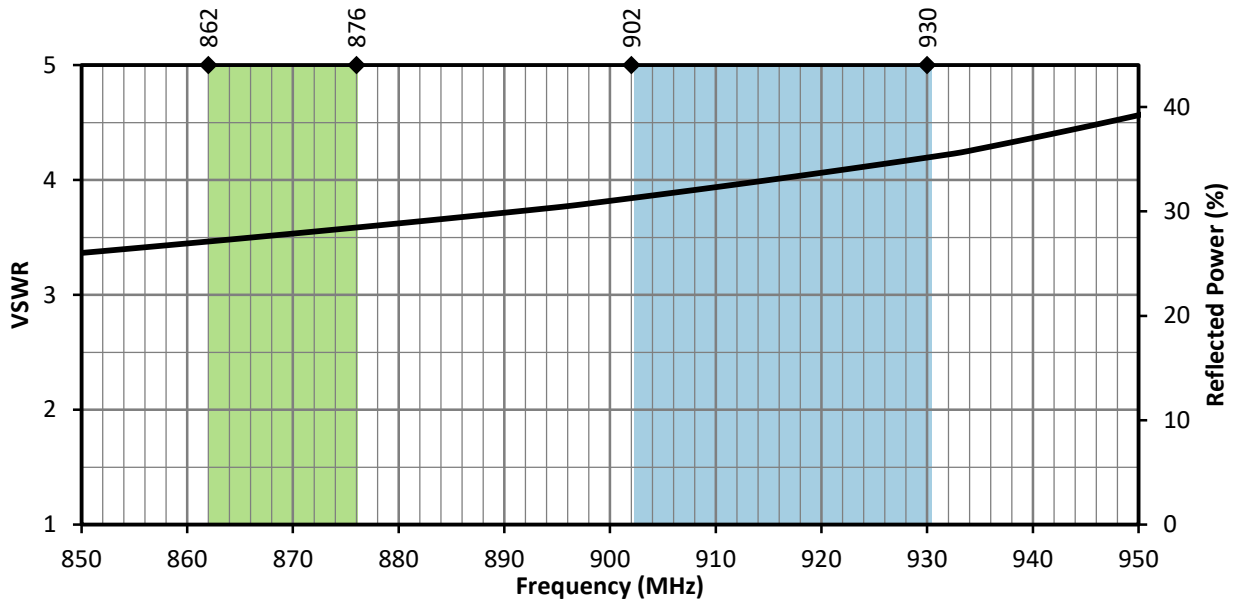

Figure 11. ANT-8/9-IPW2-NP Antenna VSWR, Center of Ground Plane

Return Loss

Return loss (Figure 12), represents the loss in power at the antenna due to reflected signals. Like VSWR, a lower return loss value indicates better antenna performance at a given frequency.

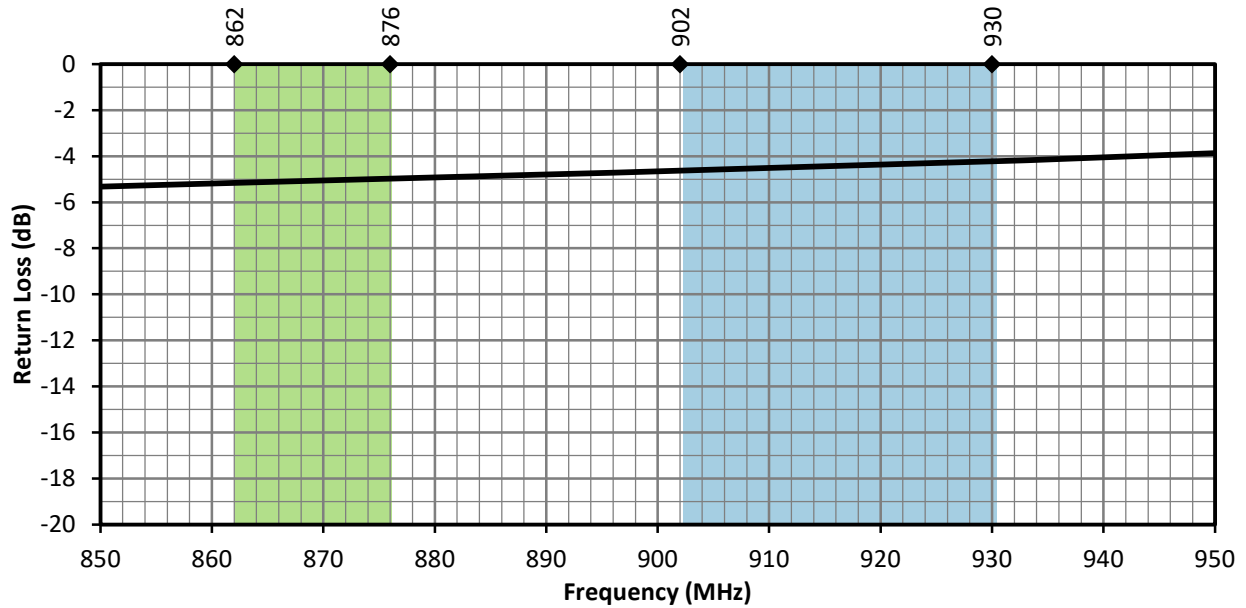

Figure 12. ANT-8/9-IPW2-NP Antenna Return Loss, Center of Ground Plane

Peak Gain

The peak gain across the antenna bandwidth is shown in Figure 13. Peak gain represents the maximum antenna input power concentration across 3-dimensional space, and therefore peak performance, at a given frequency, but does not consider any directionality in the gain pattern.

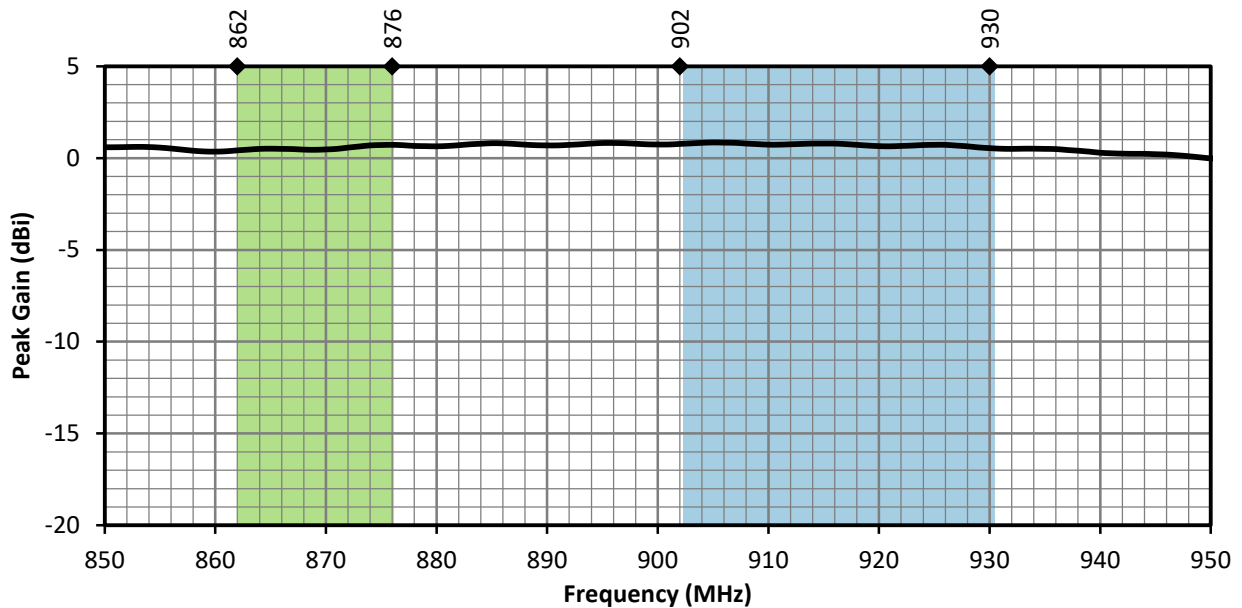

Figure 13. ANT-8/9-IPW2-NP Antenna Peak Gain, Center of Ground Plane

Average Gain

Average gain (Figure 14), is the average of all antenna gain in 3-dimensional space at each frequency, providing an indication of overall performance without expressing antenna directionality.

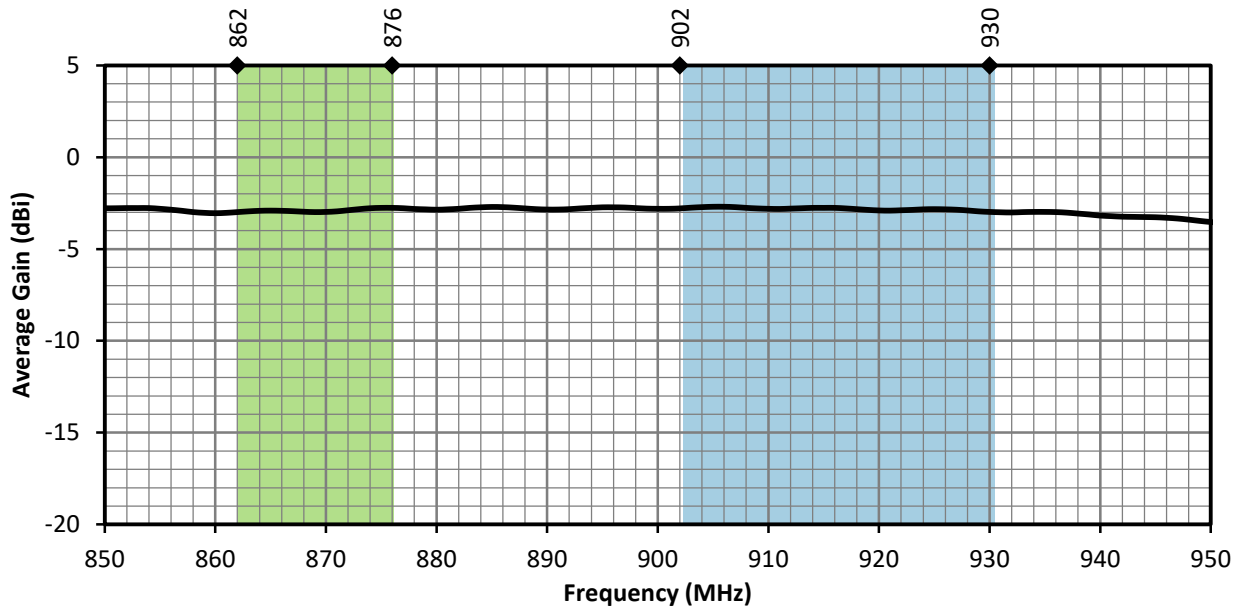

Figure 14. ANT-8/9-IPW2-NP Antenna Average Gain , Center of Ground Plane

Radiation Efficiency

Radiation efficiency (Figure 15), shows the ratio of power delivered to the antenna relative to the power radiated at the antenna, expressed as a percentage, where a higher percentage indicates better performance at a given frequency.

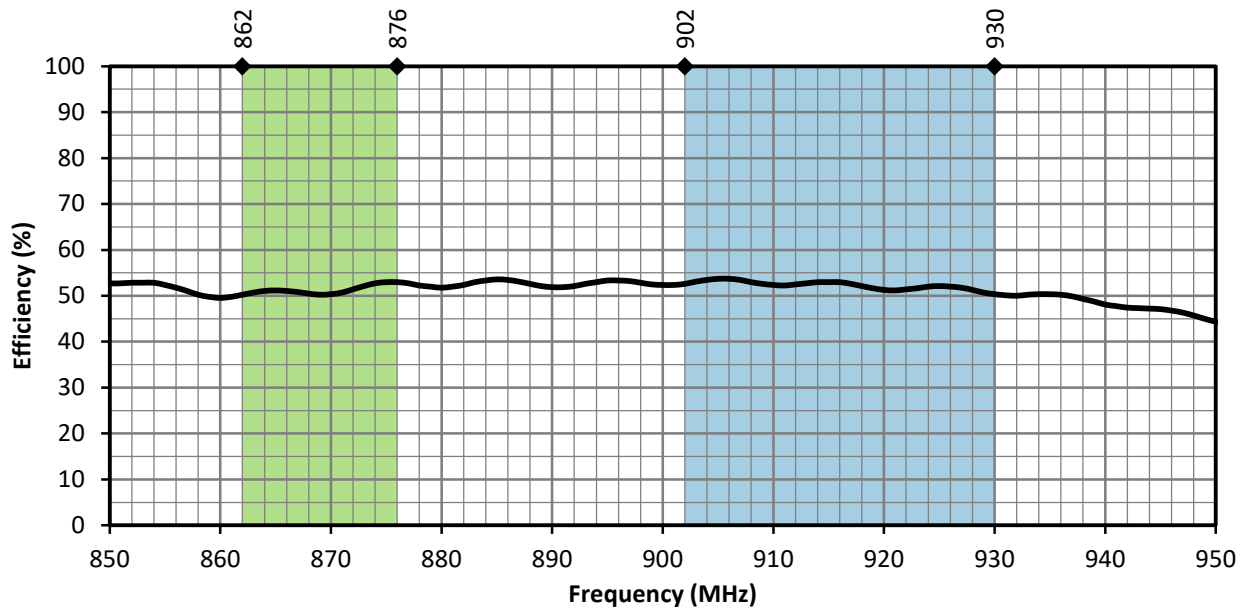
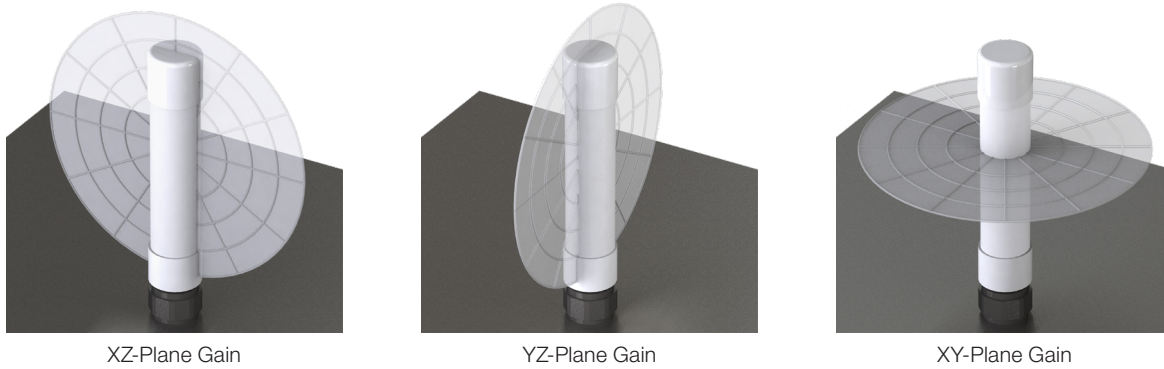

Figure 15. ANT-8/9-IPW2-NP Antenna Radiation Efficiency , Center of Ground Plane

Radiation Patterns

Radiation patterns provide information about the directionality and 3-dimensional gain performance of the antenna by plotting gain at specific frequencies in three orthogonal planes. Antenna radiation patterns for an orientation at the center of the ground plane are shown in Figure 16 using polar plots covering 360 degrees. The antenna graphic at the top of the page provides reference to the plane of the column of plots below it. Note: when viewed with typical PDF viewing software, zooming into radiation patterns is possible to reveal fine detail.

Radiation Patterns - Center of Ground Plane



862 MHz to 876 MHz (868 MHz)

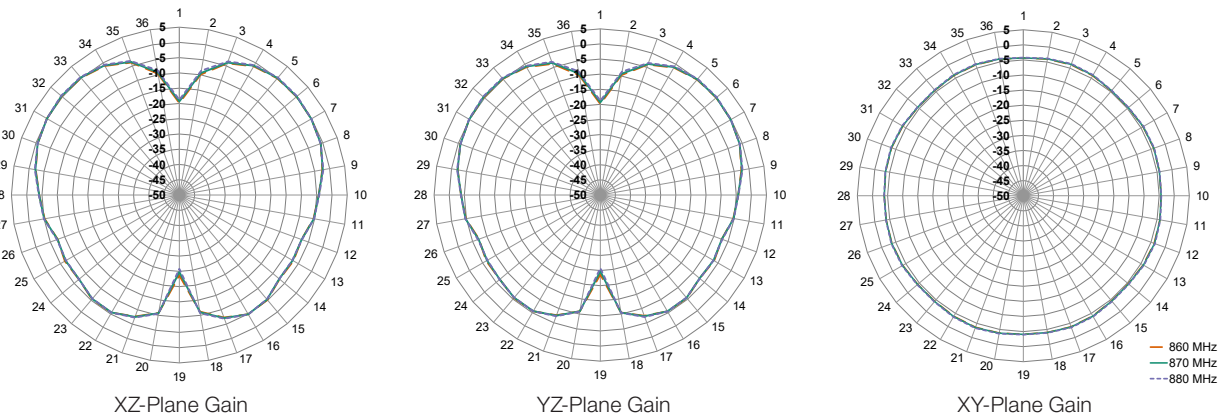

902 MHz to 930 MHz (915 MHz)

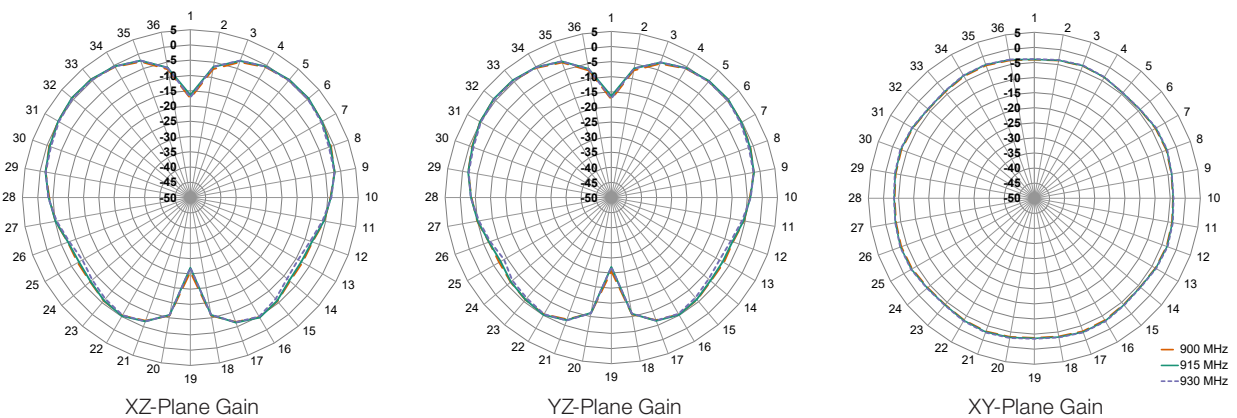

Figure 16. Radiation Patterns for ANT-8/9-IPW2-NP Antenna, Center of Ground Plane

Website: <http://linxtechnologies.com>
Linx Offices: 159 Ort Lane, Merlin, OR, US 97532
Phone: +1 (541) 471-6256
E-MAIL: info@linxtechnologies.com

Linx Technologies reserves the right to make changes to the product(s) or information contained herein without notice. No liability is assumed as a result of their use or application. No rights under any patent accompany the sale of any such product(s) or information.

Wireless Made Simple is a registered trademark of Linx Acquisitions LLC. Other product and brand names may be trademarks or registered trademarks of their respective owners.

Copyright © 2022 Linx Technologies

All Rights Reserved

Doc# DS22012-187ANT Replaces (DS21355-187ANT)

