

L1008C4R7MDMIT

Aliases (L1008C4R7MDMIT)

Obsolete

KEMET, L-DMI, Power, 4.7 uH, 20%

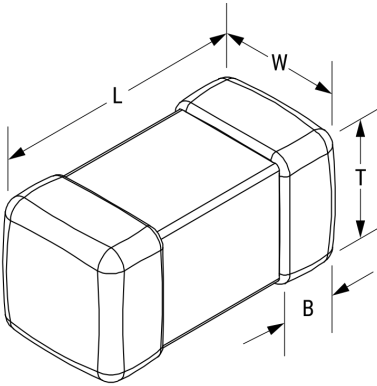

Click [here](#) for the 3D model.

Dimensions

Chip Size	1008
L	2.5mm +/-0.2mm
W	2mm +/-0.2mm
T	1mm MAX
B	0.5mm +/-0.3mm

Packaging Specifications

Packaging	T&R
Packaging Quantity	3000

General Information

Series	L-DMI
Style	SMD Chip
Description	Shielded, Surface Mount Inductor
Features	High Current Type For Power Supply Line
RoHS	Yes
Winding Type	Multilayer
Notes	Suggested Replacement - https://www.chilisin.com/en-global/Inductor/Product/BKPB_252010/BKPB002520104R7MA2 .

Specifications

Inductance	4.7 uH (1 MHz)
Inductance Tolerance	20%
Temperature Range	-40/+85°C
Shielded	Yes
Current	1100 mAmps (MAX)
DC Resistance	0.15 Ohms (Max)