

PCB terminal block - PT 2,5/ 3-7,5-H - 1988118

Please be informed that the data shown in this PDF Document is generated from our Online Catalog. Please find the complete data in the user's documentation. Our General Terms of Use for Downloads are valid (<http://phoenixcontact.com/download>)

PCB terminal block, nominal current: 32 A, pitch: 7.5 mm, number of positions: 3, connection method: Screw connection with wire protector, mounting: Wave soldering, conductor/PCB connection direction: 0 °, color: green



The figure shows a 10-position version of the product

Your advantages

- ✓ Well-known connection principle allows worldwide use
- ✓ Low temperature rise, thanks to maximum contact force
- ✓ High terminal block capacity thanks to rectangular terminal block space
- ✓ Allows connection of two conductors
- ✓ The latching on the side enables various numbers of positions to be combined



Key Commercial Data

Packing unit	250 pc
GTIN	 4 046356 036641
GTIN	4046356036641

Technical data

Dimensions

Length [l]	9 mm
Pitch	7.5 mm
Dimension a	15 mm
Width [w]	22.5 mm
Height	13.5 mm
Height [h]	17.6 mm
Solder pin [P]	4.1 mm
Pin spacing	7.5 mm
Hole diameter	1.3 mm

General

PCB terminal block - PT 2,5/ 3-7,5-H - 1988118

Technical data

General

Range of articles	PT 2,5/..-H
Insulating material group	I
Rated surge voltage (III/3)	6 kV
Rated surge voltage (III/2)	6 kV
Rated surge voltage (II/2)	6 kV
Rated voltage (III/3)	500 V
Rated voltage (III/2)	800 V
Rated voltage (II/2)	1000 V
Connection in acc. with standard	EN-VDE
Nominal current I _N	32 A
Nominal cross section	2.5 mm ²
Maximum load current	32 A
Insulating material	PA
Flammability rating according to UL 94	V0
Internal cylindrical gage	A3
Stripping length	6.5 mm
Number of positions	3
Screw thread	M3
Tightening torque, min	0.45 Nm
Tightening torque max	0.5 Nm

Connection data

Conductor cross section solid min.	0.5 mm ²
Conductor cross section solid max.	4 mm ²
Conductor cross section flexible min.	0.5 mm ²
Conductor cross section flexible max.	4 mm ²
Conductor cross section flexible, with ferrule without plastic sleeve min.	0.5 mm ²
Conductor cross section flexible, with ferrule without plastic sleeve max.	2.5 mm ²
Conductor cross section flexible, with ferrule with plastic sleeve min.	0.5 mm ²
Conductor cross section flexible, with ferrule with plastic sleeve max.	2.5 mm ²
Conductor cross section AWG min.	20
Conductor cross section AWG max.	10
2 conductors with same cross section, solid min.	0.5 mm ²
2 conductors with same cross section, solid max.	1.5 mm ²
2 conductors with same cross section, stranded min.	0.5 mm ²
2 conductors with same cross section, stranded max.	1.5 mm ²
2 conductors with same cross section, stranded, ferrules without plastic sleeve, min.	0.5 mm ²
2 conductors with same cross section, stranded, ferrules without plastic sleeve, max.	0.75 mm ² The technical data regarding clamping with ferrules applies only when using crimping pliers ZA 3. When using ferrules, it is necessary to take into account possible restrictions regarding nominal voltage.

PCB terminal block - PT 2,5/ 3-7,5-H - 1988118

Technical data

Connection data

2 conductors with same cross section, stranded, TWIN ferrules with plastic sleeve, min.	0.5 mm ²
2 conductors with same cross section, stranded, TWIN ferrules with plastic sleeve, max.	1.5 mm ² The technical data regarding clamping with ferrules applies only when using crimping pliers ZA 3. When using ferrules, it is necessary to take into account possible restrictions regarding nominal voltage.

Standards and Regulations

Connection in acc. with standard	EN-VDE
	CUL
Flammability rating according to UL 94	V0

Environmental Product Compliance

	Lead 7439-92-1
China RoHS	Environmentally Friendly Use Period = 50
	For details about hazardous substances go to tab "Downloads", Category "Manufacturer's declaration"

Drawings

Drilling diagram

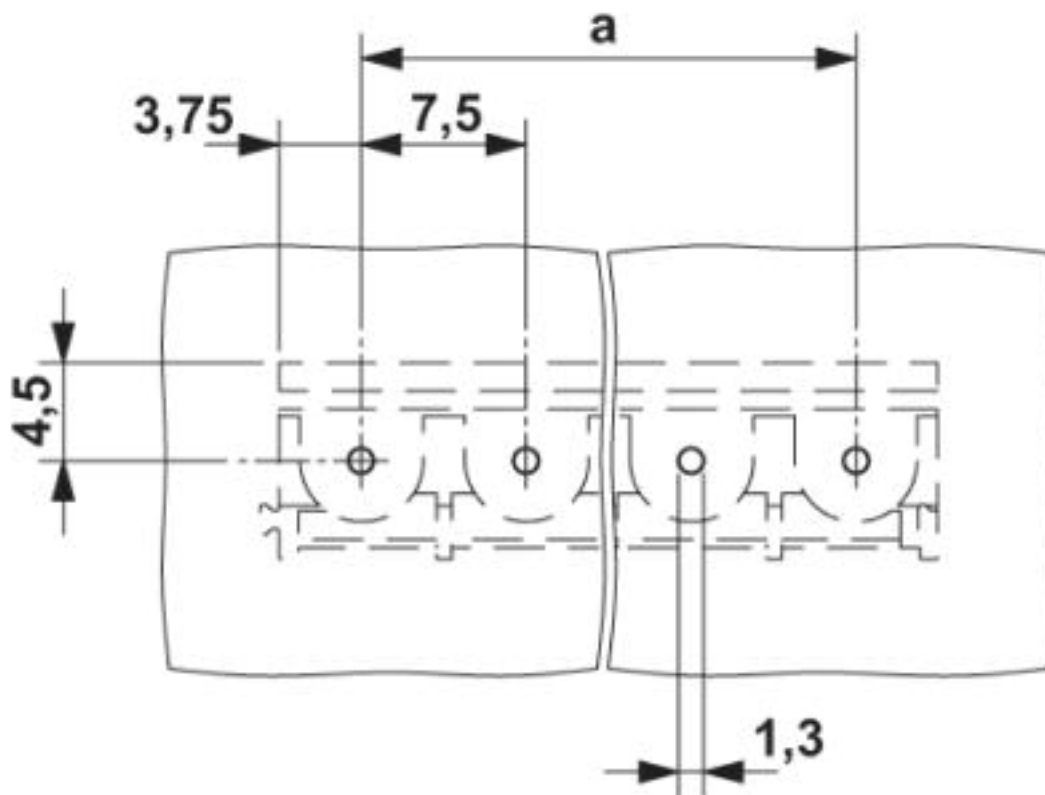

PCB terminal block - PT 2,5/ 3-7,5-H - 1988118

Diagram

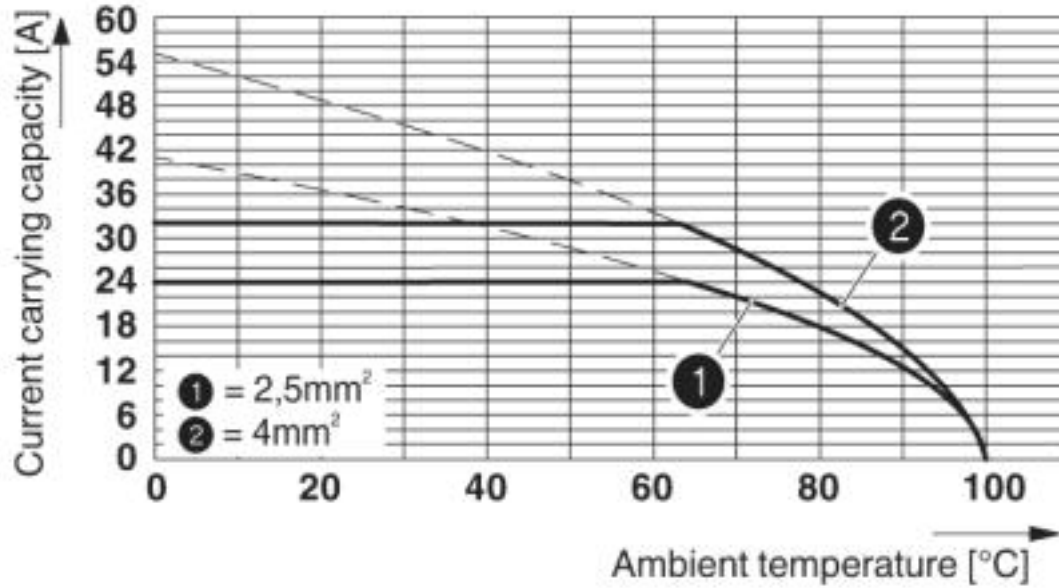

Derating diagram for 5 pins; reduction factor=1

Dimensional drawing

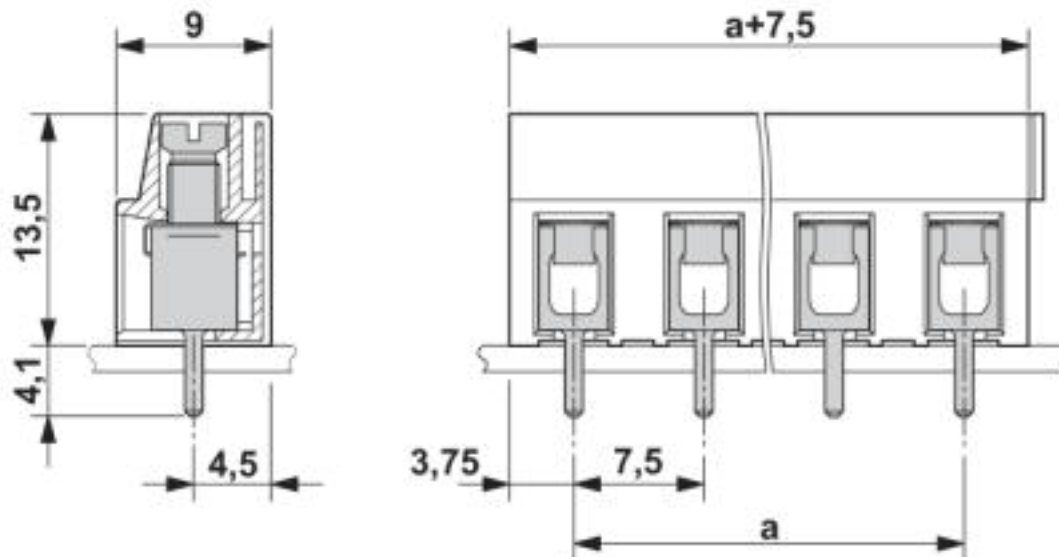

Approvals

Approvals

Approvals

CCA / IECCE CB Scheme / VDE Gutachten mit Fertigungsüberwachung / EAC / cULus Recognized

PCB terminal block - PT 2,5/ 3-7,5-H - 1988118

Approvals

Ex Approvals

Approval details

CCA	DE1 34001
Nominal voltage UN	750 V
Nominal current IN	32 A
mm ² /AWG/kcmil	0.5-4

IECEE CB Scheme		http://www.iecee.org/	DE1-58861
Nominal voltage UN	750 V		
Nominal current IN	32 A		
mm ² /AWG/kcmil	0.5-4		

VDE Gutachten mit Fertigungsüberwachung		http://www2.vde.com/de/Institut/Online-Service/VDE-gepruefteProdukte/Seiten/Online-Suche.aspx	40029839
Nominal voltage UN	750 V		
Nominal current IN	32 A		
mm ² /AWG/kcmil	0.5-4		

EAC		B.01742
-----	---	---------

cULus Recognized		http://database.ul.com/cgi-bin/XYV/template/LISEXT/1FRAME/index.htm	E60425-20030211
	B	C	D
Nominal voltage UN	300 V	150 V	300 V
Nominal current IN	20 A	20 A	10 A
mm ² /AWG/kcmil	20-12	20-12	20-12

Phoenix Contact 2019 © - all rights reserved
<http://www.phoenixcontact.com>

PHOENIX CONTACT GmbH & Co. KG
Flachmarktstr. 8
32825 Blomberg
Germany
Tel. +49 5235 300
Fax +49 5235 3 41200
<http://www.phoenixcontact.com>