

Data sheet | Item number: 2091-1132

1-conductor female connector; push-button; Push-in CAGE CLAMP®; 1.5 mm²; Pin spacing 3.5 mm; 12-pole; 1,50 mm²; light gray

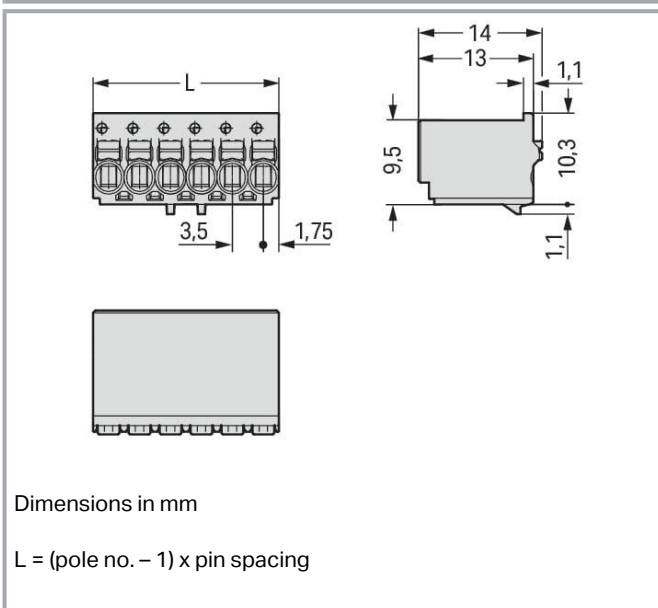

www.wago.com/2091-1132

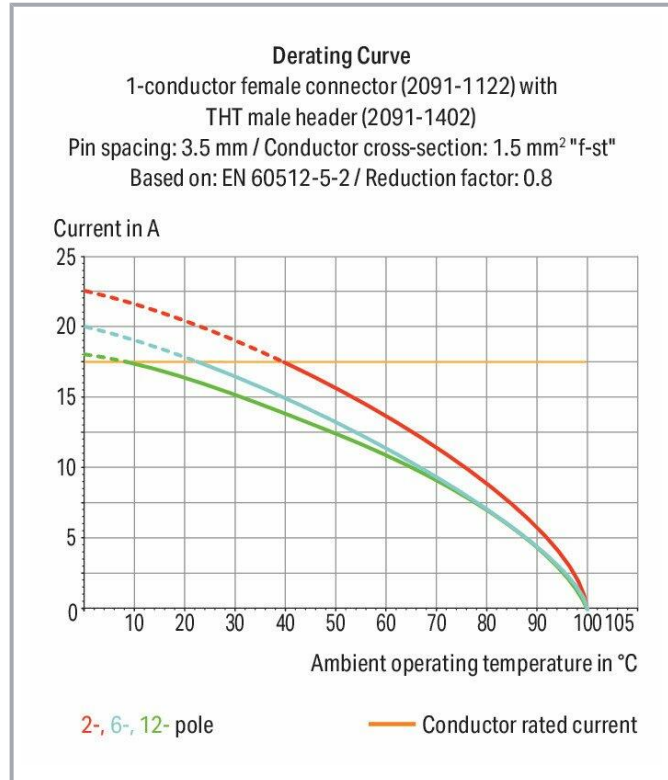
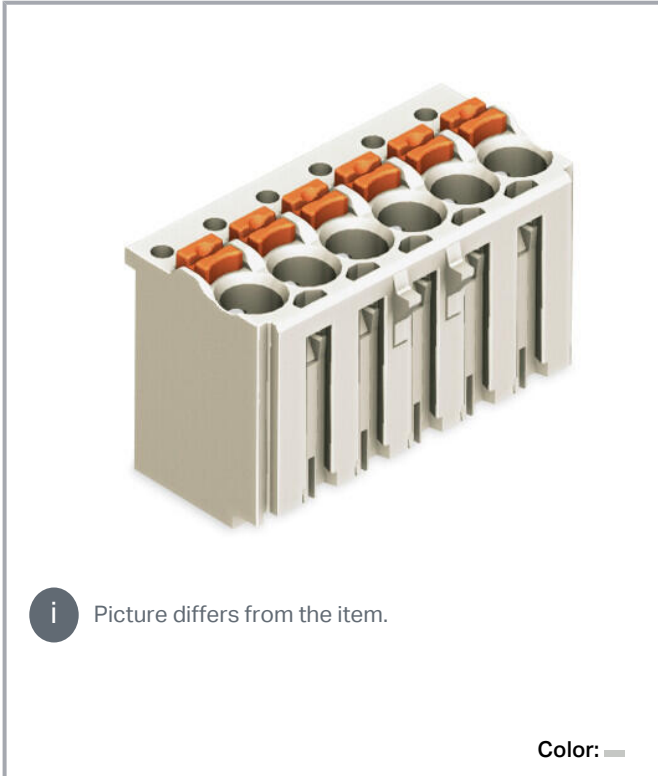

Subject to changes. Please also observe the further product documentation!

WAGO GmbH & Co. KG
Hansastr. 27
32423 Minden
Phone: +49571 887-0 | Fax: +49571 887-169
Email: info.de@wago.com | Web: www.wago.com

Do you have any questions about our products?
We are always happy to take your call at +49 (571) 887-44222.



Item description

- Universal connection of all conductor types
- Simple, push-in termination of solid and ferruled conductors
- Easy-to-use design does not require special tools
- Ability to wire while mated or unmated
- Testing parallel to conductor entry – tip contact
- Also available with gripping plates
- Integrated locking latches prevent accidental disconnection

Data

Notes

Safety information

The **picoMAX® Pluggable Connection System** includes connectors without breaking capacity in accordance with DIN EN 61984. When used as intended, these connectors must not be connected /disconnected when live or under load. The circuit design should ensure header pins, which can be touched, are not live when unmated.

Variants:

Direct marking

Other versions (or variants) can be requested from WAGO Sales or configured at <https://configurator.wago.com/>.

Electrical data

Ratings per IEC/EN

Ratings per	IEC/EN 60664-1
Nominal voltage (III/3)	160 V
Rated impulse voltage (III/3)	2.5 kV
Rated voltage (III/2)	160 V
Rated impulse voltage (III/2)	2.5 kV
Nominal voltage (II/2)	320 V
Rated surge voltage (II/2)	2.5 kV
Rated current	10 A
Legend (ratings)	(III / 2) ≙ Overvoltage category III / Pollution degree 2

Ratings per UL 1059

Approvals per	UL 1059
---------------	---------

Subject to changes. Please also observe the further product documentation!

WAGO GmbH & Co. KG
 Hansastr. 27
 32423 Minden
 Phone: +49571 887-0 | Fax: +49571 887-169
 Email: info.de@wago.com | Web: www.wago.com

Do you have any questions about our products?
 We are always happy to take your call at +49 (571) 887-44222.



Rated voltage UL (Use Group B)	300 V
Rated current UL (Use Group B)	10 A
Rated voltage UL (Use Group D)	300 V
Rated current UL (Use Group D)	10 A

Connection data

Connection points	12
Total number of potentials	12
Number of connection types	1
Number of levels	1

Connection 1

Connection technology	Push-in CAGE CLAMP®
Actuation type	Push-button
Actuation direction 1	Operation parallel to conductor entry
Solid conductor	0.2 ... 1.5 mm ² / 24 ... 14 AWG
Fine-stranded conductor	0.2 ... 1.5 mm ² / 24 ... 14 AWG
Fine-stranded conductor; with insulated ferrule	0.25 ... 0.75 mm ²
Fine-stranded conductor; with uninsulated ferrule	0.25 ... 1.5 mm ²
Strip length	8 ... 9 mm / 0.31 ... 0.35 inches
Pole number	12

Physical data

Pin spacing	3.5 mm / 0.138 inches
Width	42 mm / 1.654 inches
Height	14 mm / 0.551 inches
Depth	11.4 mm / 0.449 inches

Mechanical Data

Variable coding	Yes
Anti-rotation protection	Yes

Plug-in connection

Contact type (pluggable connector)	Female connector/socket
Connector (connection type)	for conductor
Mismating protection	No

Subject to changes. Please also observe the further product documentation!



Plugging without loss of pin spacing	Yes
Locking of plug-in connection	none

Material Data

Note (material data)	Information on material specifications can be found here
Color	light gray
Material group	I
Insulation material	Polyphthalamide (PPA GF)
Flammability class per UL94	V0
Clamping spring material	Chrome-nickel spring steel (CrNi)
Contact material	Electrolytic copper (E _{Cu})
Contact plating	Tin
Fire load	0.018 MJ
Weight	5.1 g

Environmental requirements

Limit temperature range	-60 ... +100 °C
Processing temperature	-35 ... +60 °C

Commercial data

Product Group	26 (picoMAX Connectors)
eCl@ss 10.0	27-14-11-06
eCl@ss 9.0	27-14-11-06
ETIM 8.0	EC001284
ETIM 7.0	EC001284
PU (SPU)	100 pcs
Packaging type	box
Country of origin	DE
GTIN	4050821160823
Customs tariff number	85366990990

Environmental Product Compliance

RoHS Compliance Status	Compliant, No Exemption
------------------------	-------------------------





Approvals / Certificates

Subject to changes. Please also observe the further product documentation!





WAGO GmbH & Co. KG
 Hansastr. 27
 32423 Minden
 Phone: +49571 887-0 | Fax: +49571 887-169
 Email: info.de@wago.com | Web: www.wago.com

Do you have any questions about our products?
 We are always happy to take your call at +49 (571) 887-44222.













General approvals

Logo	Approval	Additional Approval Text	Certificate name
	CB DEKRA Certification B.V.	IEC 61984	NL-49736 /A1
	CSA DEKRA Certification B.V.	C22.2 No. 158	2362521
	CSA DEKRA Certification B.V.	C22.2	2362521
	KEMA/KEUR DEKRA Certification B.V.	EN 61984	71- 102260 REV.1
	UL Underwriters Laboratories Inc.	UL 1977	E45171
	UR Underwriters Laboratories Inc.	UL 1059	E45172

Counterpart

	Item no.2091-1412 THT male header; 1.0 mm Ø solder pin; straight; Pin spacing 3.5 mm; 12-pole; light gray	www.wago.com/2091-1412
	Item no.2091-1412/200-000 THR male header; 1.0 mm Ø solder pin; straight; Pin spacing 3.5 mm; 12-pole; light gray	www.wago.com/2091-1412/200-000
	Item no.2091-1432 THT male header; 1.0 mm Ø solder pin; angled; Pin spacing 3.5 mm; 12-pole; light gray	www.wago.com/2091-1432
	Item no.2091-1432/205-000 THR male header; 1.0 mm Ø solder pin; angled; clamping collar; Pin spacing 3.5 mm; 12-pole; light gray	www.wago.com/2091-1432/205-000

Subject to changes. Please also observe the further product documentation!

	Item no.2091-1412/205-000 THR male header; 1.0 mm Ø solder pin; straight; clamping collar; Pin spacing 3.5 mm; 12-pole; light gray	www.wago.com/2091-1412/205-000
	Item no.2091-1432/200-000 THR male header; 1.0 mm Ø solder pin; angled; Pin spacing 3.5 mm; 12-pole; light gray	www.wago.com/2091-1432/200-000
	Item no.2091-1512/002-3000 1-conductor male connector; Push-in CAGE CLAMP®; 1.5 mm²; Pin spacing 3.5 mm; 12-pole; Gripping plate; direct marking; 1,50 mm²; light gray	www.wago.com/2091-1512/002-3000
	Item no.2091-1512/002-000 1-conductor male connector; Push-in CAGE CLAMP®; 1.5 mm²; Pin spacing 3.5 mm; 12-pole; Gripping plate; 1,50 mm²; light gray	www.wago.com/2091-1512/002-000
	Item no.2091-1532/002-000 1-conductor male connector; Push-in CAGE CLAMP®; 1.5 mm²; Pin spacing 3.5 mm; 12-pole; Integrated release lever; 1,50 mm²; light gray	www.wago.com/2091-1532/002-000
	Item no.2091-1532/020-000 1-conductor male connector; Push-in CAGE CLAMP®; 1.5 mm²; Pin spacing 3.5 mm; 12-pole; DIN-35 rail/panel mounting; Snap-in mounting feet; Integrated release lever; 1,50 mm²; light gray	www.wago.com/2091-1532/020-000
	Item no.2091-1532/002-3000 1-conductor male connector; Push-in CAGE CLAMP®; 1.5 mm²; Pin spacing 3.5 mm; 12-pole; Integrated release lever; direct marking; 1,50 mm²; light gray	www.wago.com/2091-1532/002-3000
	Item no.2091-1532/020-3000 1-conductor male connector; Push-in CAGE CLAMP®; 1.5 mm²; Pin spacing 3.5 mm; 12-pole; DIN-35 rail/panel mounting; Snap-in mounting feet; Integrated release lever; direct marking; 1,50 mm²; light gray	www.wago.com/2091-1532/020-3000
	Item no.2091-1712 THT male header; 1.0 mm Ø solder pin; straight; Pin spacing 3.5 mm; 12-pole; black	www.wago.com/2091-1712
	Item no.2091-1712/200-000 THR male header; 1.0 mm Ø solder pin; straight; Pin spacing 3.5 mm; 12-pole; black	www.wago.com/2091-1712/200-000
	Item no.2091-1732 THT male header; 1.0 mm Ø solder pin; angled; Pin spacing 3.5 mm; 12-pole; black	www.wago.com/2091-1732
	Item no.2091-1732/200-000 THR male header; 1.0 mm Ø solder pin; angled; Pin spacing 3.5 mm; 12-pole; black	www.wago.com/2091-1732/200-000

Optional accessories

Strain relief

Strain relief plate

 **Item no.: 2091-1603**

Subject to changes. Please also observe the further product documentation!

WAGO GmbH & Co. KG

Hansastr. 27

32423 Minden

Phone: +49571 887-0 | Fax: +49571 887-169

Email: info.de@wago.com | Web: www.wago.com

Do you have any questions about our products?

We are always happy to take your call at +49 (571) 887-44222.

Gripping plate; for female and male connectors; 1 part; Pin spacing 3.5 mm; light gray

www.wago.com/2091-1603

Testing and measuring

Testing accessories



Item no.: 735-500

WAGO Test pin; 1 mm Ø; 30 V AC / 60 V DC; CAT0; 1 A; 6 mm uninsulated; Test lead for soldering up to 0,5mm² www.wago.com/735-500

Tool

Operating tool



Item no.: 2092-1630

Unlocking tool; orange

www.wago.com/2092-1630



Item no.: 210-719

Operating tool; Blade: 2.5 x 0.4 mm; with a partially insulated shaft

www.wago.com/210-719

Coding

Coding



Item no.: 2091-1610

Coding key carrier; suitable for 3.5 mm pin spacing; orange

www.wago.com/2091-1610

Downloads

Documentation

Additional Information

Technical Section	2019 Apr 3	pdf	Download
Technical explanations		2.0 MB	

CAD/CAE-Data

CAD data

2D/3D Models 2091-1132	URL	Download
------------------------	-----	----------

CAE data

ZUKEN Portal 2091-1132	URL	Download
------------------------	-----	----------

Environmental Product Compliance

Compliance Search

Environmental Product Compliance 2091-1132	URL	Download
--	-----	----------

Subject to changes. Please also observe the further product documentation!

1-conductor female connector; push-button; Push-in CAGE CLAMP®; 1.5 mm²; Pin spacing 3.5 mm; 12-pole; 1,50 mm²; light gray

Installation Notes

Locking system

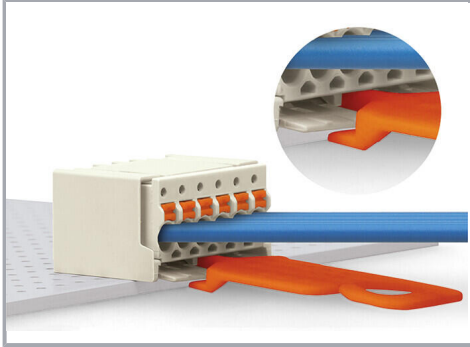

Disconnecting a female connector via unlocking tool. Plug unlocking tool into the male header's locking latch.

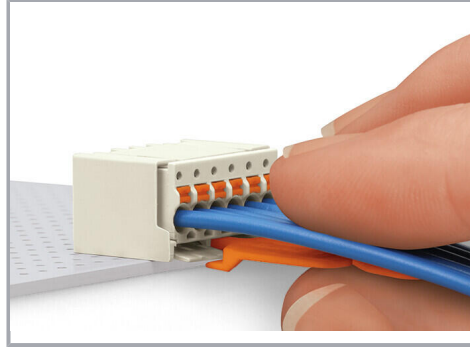

Insert unlocking tool until it hits the backstop. Wedge opens locking latches.

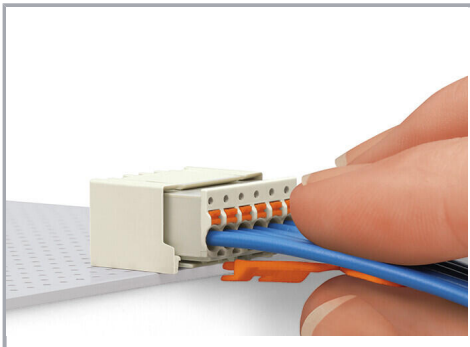

Pull on both unlocking tool and conductors to remove female connector from male header.

Conductor termination

Subject to changes. Please also observe the further product documentation!

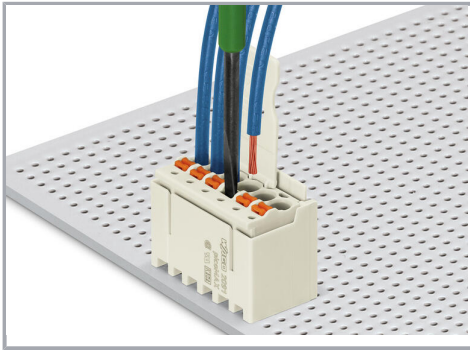

Inserting fine-stranded conductor into mated female connector via push-button.

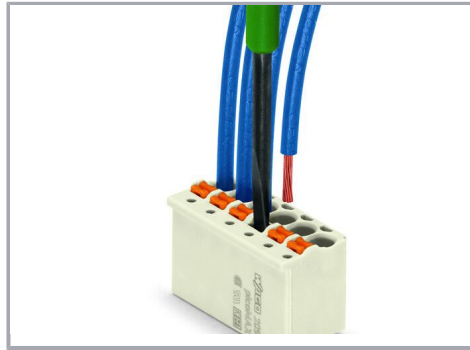

Inserting a fine-stranded conductor into an unmated female connector via push-button.

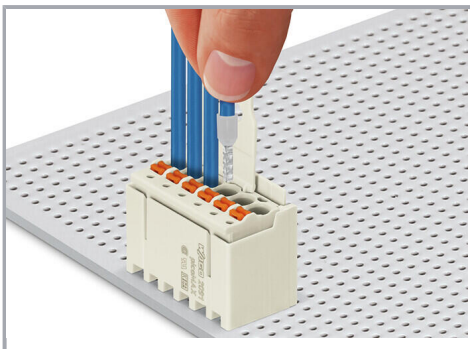

Inserting solid and ferruled conductors via push-in termination.

Marking



Pole marking via factory direct marking.

Coding

Subject to changes. Please also observe the further product documentation!

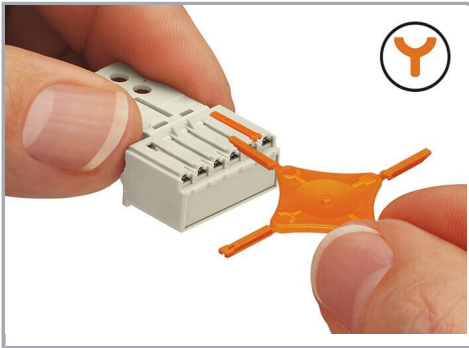

Coding a female connector (via coding key carrier and two keys for female connector, see symbol).

Testing

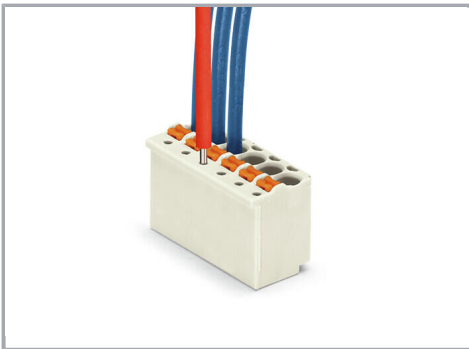

Testing via 1 mm Ø test pin – touch contact.

Subject to changes. Please also observe the further product documentation!