



# 35W Multiple-Stage Constant Current Mode LED Driver **LCM-40U** series



Standard



Optional



## ■ Features

- Constant Current mode output with multiple levels selectable by dip switch
- Plastic housing with class II design
- Built-in active PFC function
- Functions: 3 in 1 dimming (dim-to-off); Auxiliary DC output; synchronization up to 10 units
- Optional: Wireless LED driver with integrated EnOcean module
- 3 years warranty

## ■ Applications

- LED indoor lighting
- LED office lighting
- LED architectural lighting
- LED panel lighting

## ■ Description

LCM-40U series is a 35W LED AC/DC constant current mode output LED driver featuring the multiple levels selectable by dip switch. LCM-40U operates from 90~132VAC and offers different current levels ranging between 350mA and 1050mA. Thanks to the efficiency up to 87.5%, with the fanless design, the entire series is able to operate for -30°C~+90°C case temperature under free air convection. LCM-40U is equipped with various functions, such as the dimming function and synchronization, so as to provide the optimal design flexibility for LED lighting system.

## ■ Model Encoding

LCM - 40U   

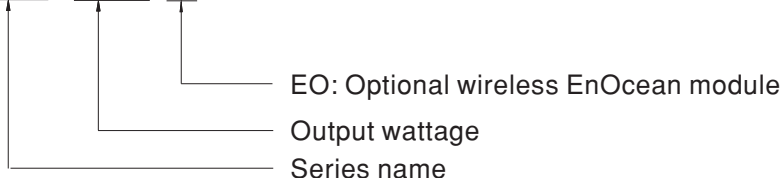

| Type  | Function                                       | Note       |
|-------|--|------------|
| Blank | 3 in 1 dimming (dime-to-off)                   | In Stock   |
| EO    | Wireless driver with integrated EnOcean module | By request |



# 35W Multiple-Stage Constant Current Mode LED Driver **LCM-40U** series

## SPECIFICATION

| MODEL                            |   | LCM-40U   |         |         |                |         |         |
|----------------------------------|---|---|---------|---------|----------------|---------|---------|
| OUTPUT                           | CURRENT LEVEL   | Current level selectable via DIP switch, please refer to "DIP SWITCH TABLE" section         |         |         |                |         |         |
|                                  |   | 350mA   | 500mA   | 600mA   | 700mA(default) | 900mA   | 1050mA  |
|                                  | RATED POWER   | 35W   |         |         |                |         |         |
|                                  | DC VOLTAGE RANGE  | 2 ~ 100V  | 2 ~ 70V | 2 ~ 59V | 2 ~ 50V        | 2 ~ 39V | 2 ~ 34V |
|                                  | OPEN CIRCUIT VOLTAGE (max.)   | 110   |         |         | 76V            |         |         |
|                                  | CURRENT RIPPLE <small>Note.6</small>  | 5.0% max. @rated current  |         |         |                |         |         |
|                                  | CURRENT TOLERANCE   | ±5%   |         |         |                |         |         |
|                                  | AUXILIARY DC OUTPUT   | Nominal 12V(deviation 11.4~12.6V)@50mA  |         |         |                |         |         |
| SETUP TIME <small>Note.3</small> | 1000ms / 115VAC   |   |         |         |                |         |         |
| INPUT                            | VOLTAGE RANGE <small>Note.2</small>   | 90 ~ 132VAC 127 ~ 186VDC<br>(Please refer to "STATIC CHARACTERISTIC" section)               |         |         |                |         |         |
|                                  | FREQUENCY RANGE   | 47 ~ 63Hz   |         |         |                |         |         |
|                                  | POWER FACTOR (Typ.)   | PF ≥ 0.98/115VAC @full load<br>(Please refer to "POWER FACTOR (PF) CHARACTERISTIC" section) |         |         |                |         |         |
|                                  | TOTAL HARMONIC DISTORTION   | THD < 20% (@load ≥ 60%)<br>(Please refer to "TOTAL HARMONIC DISTORTION(THD)" section)       |         |         |                |         |         |
|                                  | EFFICIENCY (Typ.) <small>Note.4</small>   | 87.5%   |         |         |                |         |         |
|                                  | AC CURRENT (Typ.)   | 0.43A/115VAC  |         |         |                |         |         |
|                                  | INRUSH CURRENT (Typ.)   | COLD START 15A(twidth=270μs measured at 50% I <sub>peak</sub> ) at 115VAC; Per NEMA 410     |         |         |                |         |         |
|                                  | MAX. No. of PSUs on 16A CIRCUIT BREAKER   | 22 units (circuit breaker of type B) / 38 units (circuit breaker of type C) at 115VAC       |         |         |                |         |         |
| LEAKAGE CURRENT                  | <0.5mA / 120VAC   |   |         |         |                |         |         |
| PROTECTION                       | SHORT CIRCUIT   | Constant current limiting, recovers automatically after fault condition is removed          |         |         |                |         |         |
|                                  | OVER VOLTAGE  | 110 ~ 130V<br>Shutdown o/p voltage, re-power on to recover                                  |         |         |                |         |         |
|                                  | OVER TEMPERATURE  | Shutdown o/p voltage, re-power on to recover  |         |         |                |         |         |
| FUNCTION                         | WIRELESS PROTOCOL(Optional)   | EnOcean standard 902 MHz or USA/Canada; Max. device(switch) saved into the memory : 33      |         |         |                |         |         |
|                                  | DIMMING   | Please refer to "DIMMING OPERATION" section   |         |         |                |         |         |
|                                  | SYNCHRONIZATION   | Please refer to "SYNCHRONIZATION OPERATION" section   |         |         |                |         |         |
|                                  | TEMP. COMPENSATION  | By external NTC, please refer to "TEMPERATURE COMPENSATION OPERATION" section               |         |         |                |         |         |
| ENVIRONMENT                      | WORKING TEMP.   | T <sub>case</sub> = -30 ~ +90°C (Please refer to "OUTPUT LOAD vs TEMPERATURE" section)      |         |         |                |         |         |
|                                  | MAX. CASE TEMP.   | T <sub>case</sub> = +90°C   |         |         |                |         |         |
|                                  | WORKING HUMIDITY  | 20 ~ 90% RH non-condensing  |         |         |                |         |         |
|                                  | STORAGE TEMP., HUMIDITY   | -40 ~ +80°C, 10 ~ 95% RH  |         |         |                |         |         |
|                                  | TEMP. COEFFICIENT   | ±0.03%/°C (0 ~ 40°C)  |         |         |                |         |         |
|                                  | VIBRATION   | 10 ~ 500Hz, 2G 10min./1cycle, period for 60min. each along X, Y, Z axes                     |         |         |                |         |         |
| SAFETY & EMC                     | SAFETY STANDARDS  | UL8750 approved   |         |         |                |         |         |
|                                  | DALI STANDARDS  | Comply with IEC62386-101, 102, 207  |         |         |                |         |         |
|                                  | WITHSTAND VOLTAGE   | I/P-O/P: 3.75KVAC   |         |         |                |         |         |
|                                  | ISOLATION RESISTANCE  | I/P-O/P: >100M Ohms / 500VDC / 25°C / 70% RH  |         |         |                |         |         |
|                                  | EMC EMISSION  | Compliance to FCC part 15 Subpart B   |         |         |                |         |         |
| OTHERS                           | MTBF  | 193.6K hrs min. MIL-HDBK-217F (25°C)  |         |         |                |         |         |
|                                  | DIMENSION   | 123.5*81.5*23mm (L*W*H)   |         |         |                |         |         |
|                                  | PACKING   | 0.28Kg ; 54pcs/16Kg/1.12CUFT  |         |         |                |         |         |
| NOTE                             | <ol style="list-style-type: none"> <li>All parameters NOT specially mentioned are measured at 115VAC input, rated current and 25°C of ambient temperature.</li> <li>De-rating may be needed under low input voltages. Please refer to "STATIC CHARACTERISTIC" sections for details.</li> <li>Length of set up time is measured at first cold start. Turning ON/OFF the driver may lead to increase of the set up time.</li> <li>Efficiency is measured at 700mA/72V output set by DIP switch.</li> <li>The driver is considered as a component that will be operated in combination with final equipment. Since EMC performance will be affected by the complete installation, the final equipment manufacturers must re-qualify EMC Directive on the complete installation again.</li> <li>It is measured 60%~100% of maximum voltage under rated power delivery.</li> </ol> |   |         |         |                |         |         |

## ■ BLOCK DIAGRAM

PFC fosc : 60KHz  
PWM fosc : 80KHz

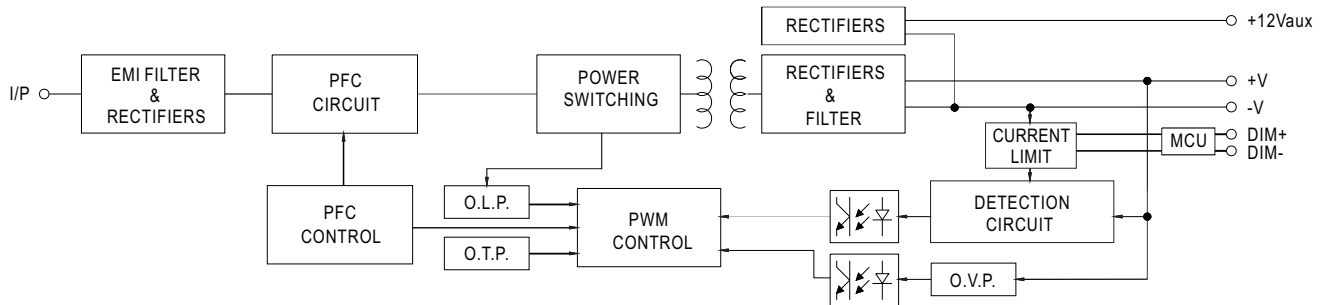

## ■ DIP SWITCH TABLE

LCM-40U is a multiple-stage constant current driver, selection of output current through DIP switch is exhibited below.

| Io \ DIP S.W.          | 1    | 2    | 3    | 4    | 5    | 6    |
|------------------------|------|------|------|------|------|------|
| 350mA                  | ---- | ---- | ---- | ---- | ---- | ---- |
| 500mA                  | ON   | ---- | ---- | ---- | ---- | ---- |
| 600mA                  | ON   | ON   | ---- | ---- | ---- | ---- |
| 700mA(factory default) | ON   | ON   | ON   | ---- | ---- | ON   |
| 900mA                  | ON   | ON   | ON   | ON   | ---- | ON   |
| 1050mA                 | ON   | ON   | ON   | ON   | ON   | ON   |

## ■ DIMMING OPERATION

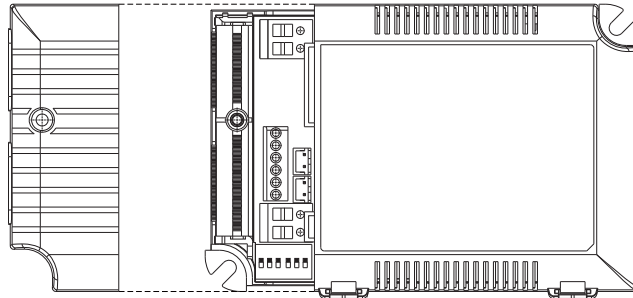

### ※ 3 in 1 dimming function

- Output constant current level can be adjusted by applying one of the three methodologies between DIM+ and DIM-:  
0 ~ 10VDC, or 10V PWM signal or resistance. For optional EO model, the 3 in 1 dimming is via SYNC+ and SYNC-(CN100 or CN101 connector).
- Direct connecting to LEDs is suggested. It is not suitable to be used with additional drivers.
- Dimming source current from power supply: 100 $\mu$ A (typ.)

#### ◎ Applying additive 0 ~ 10VDC

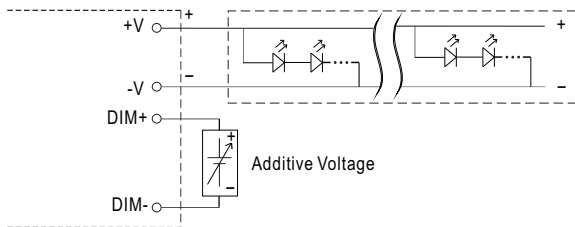

"DO NOT connect "DIM- to -V"

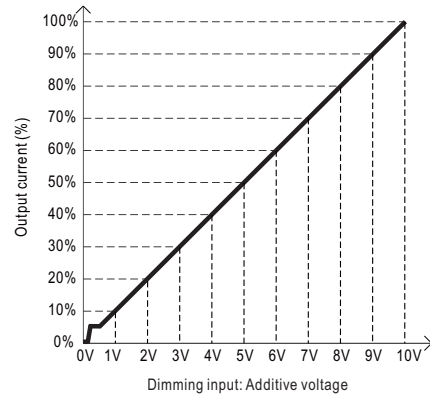

#### ◎ Applying additive 10V PWM signal (frequency range 100Hz ~ 3KHz):

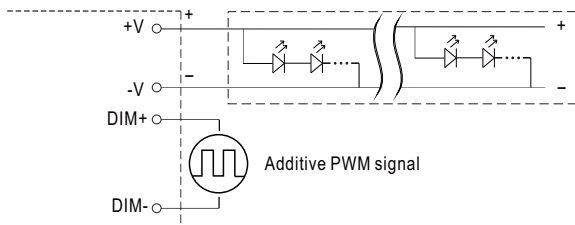

"DO NOT connect "DIM- to -V"

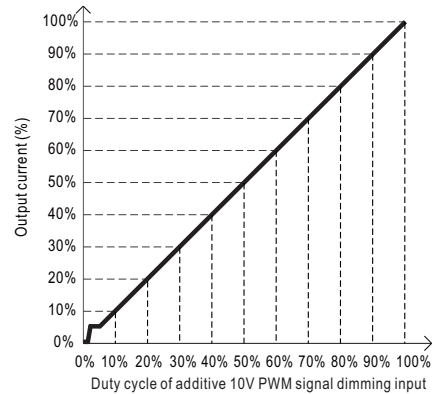

#### ◎ Applying additive resistance:

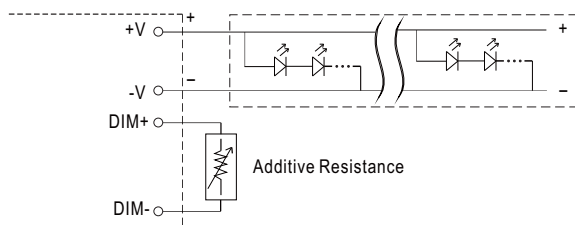

"DO NOT connect "DIM- to -V"

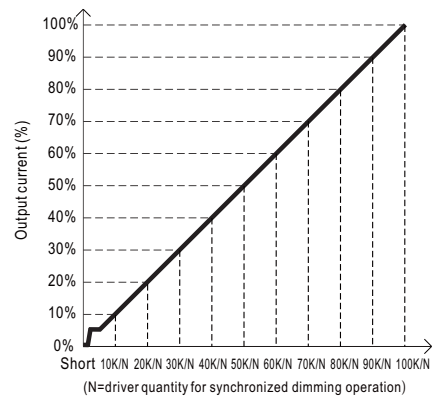

- Note : 1. Min. dimming level is about 6% and the output current is not defined when  $0\% < I_{out} < 6\%$ .  
 2. The output current could drop down to 0% when dimming input is about 0k $\Omega$  or 0Vdc, or 10V PWM signal with 0% duty cycle.  
 3. Please do not activate "temperature compensation" when performing dimming operation.

## ■ SYNCHRONIZATION OPERATION

- Synchronization up to 10 drivers (1 master + 9 slaves)
- Maximum cable length between each unit : 20 meter.

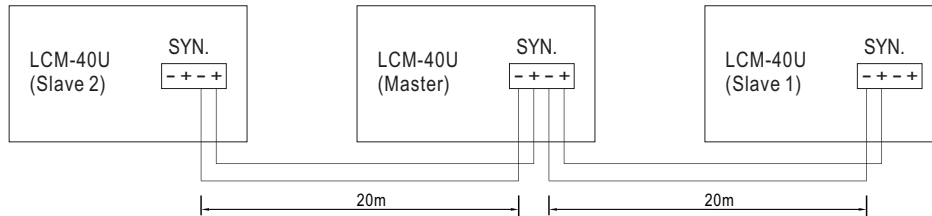

NOTE: Please make sure all units are set to 100% dimming setting(factory default) before synchronizing.  
For optional EO model: the master is EO and the salve could be standard model for economic arrangement.

## ■ TEMPERATURE COMPENSATION OPERATION

LCM-40U have the built-in temperature compensation function ; by connecting a temperature sensor (NTC resistor) between the +NTC / -NTC terminal of LCM-40U and the detecting point on the lighting system or the surrounding environment, output current of LCM-40U could be correspondingly changed, based on the sensed temperature, to ensure the long life of LED.

**NTC derating curve**

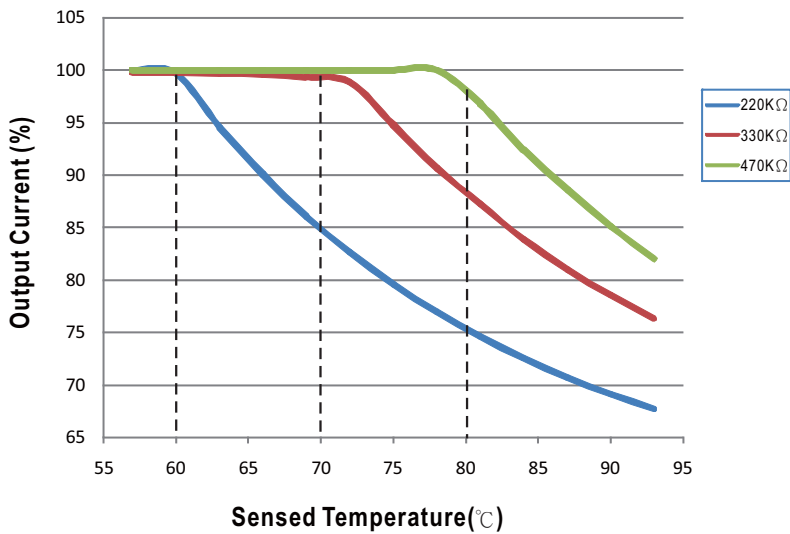

- ⊙ LCM-40U can still be operated normally when the NTC resistor is not connected and the value of output current will be the current level selected through the DIP switch.
- ⊙ NTC reference:

| NTC resistance | Output Current  |
|----------------|---|
| 220K           | < 60°C, 100% of the rated current (corresponds to the setting current level)<br>> 60°C, output current begins to reduce, please refer to the curve for details. |
| 330K           | < 70°C, 100% of the rated current (corresponds to the setting current level)<br>> 70°C, output current begins to reduce, please refer to the curve for details. |
| 470K           | < 80°C, 100% of the rated current (corresponds to the setting current level)<br>> 80°C, output current begins to reduce, please refer to the curve for details. |

Notes: 1. MEAN WELL does not offer the NTC resistor and all the data above are measured by using THINKING TTC03 series.  
2. If other brands of NTC resistor is applied, please check the temperature curve first.

- ⊙ Dimming and synchronization function of the driver will be invalid when the "temperature compensation" function is in use.

## OUTPUT LOAD vs TEMPERATURE

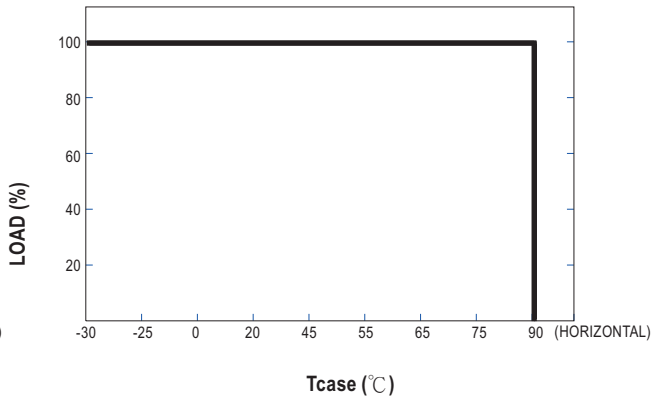
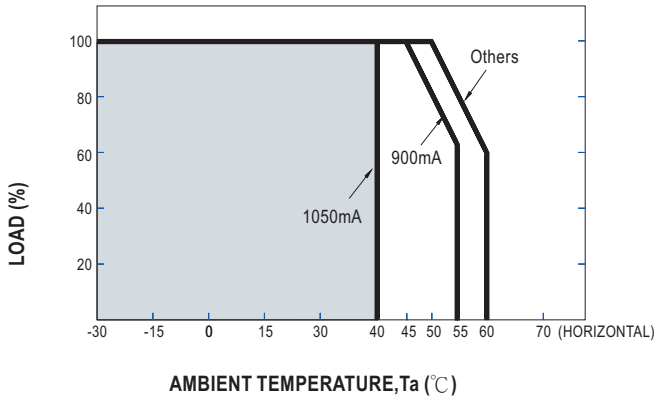

## STATIC CHARACTERISTIC

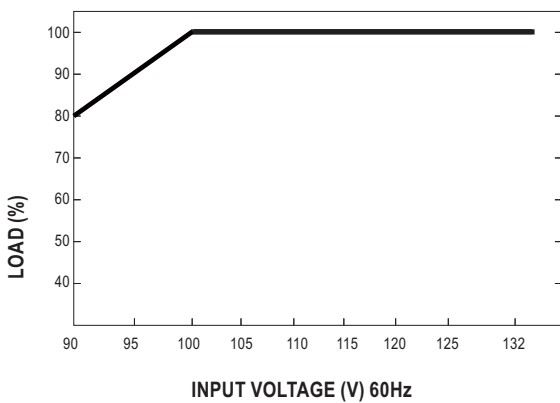

※ De-rating is needed under low input voltage.

## POWER FACTOR (PF) CHARACTERISTIC

※  $T_{case}$  at 80°C

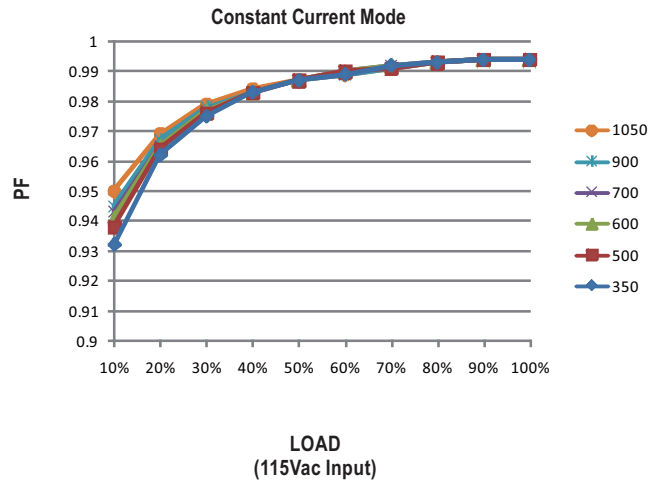

## TOTAL HARMONIC DISTORTION (THD)

※  $T_{case}$  at 80°C

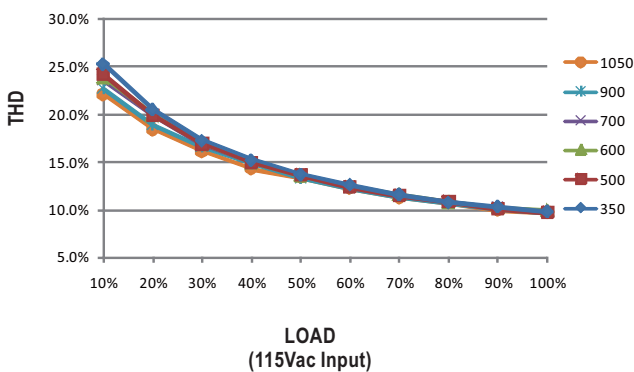

## EFFICIENCY vs LOAD

LCM-40U series possess superior working efficiency that up to 87.5% can be reached in field applications.

※  $T_{case}$  at 80°C

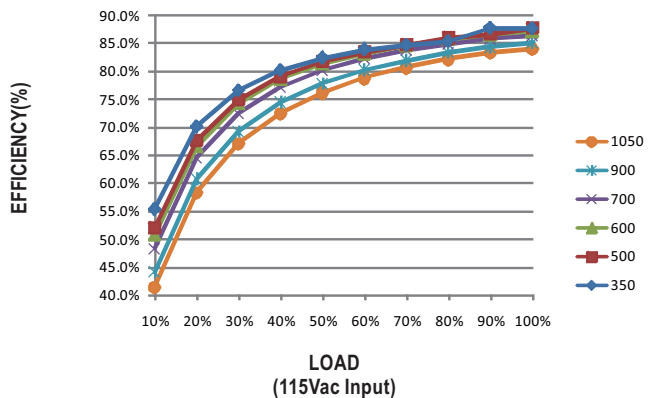

## MECHANICAL SPECIFICATION

Case No.LCM-60A Unit:mm

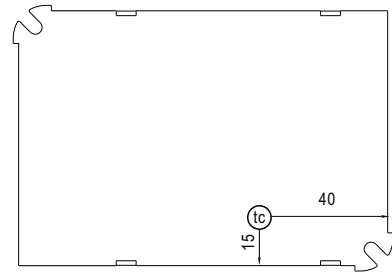
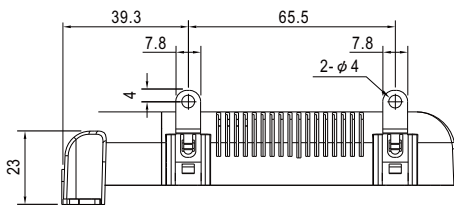
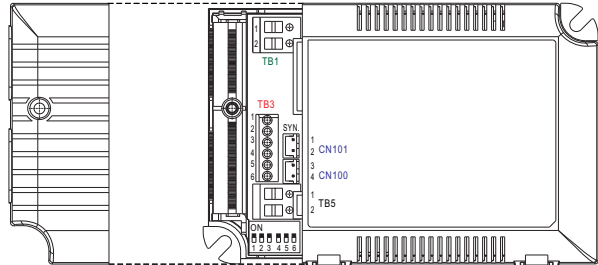
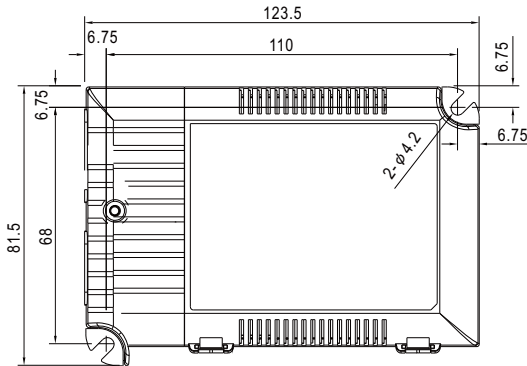

Bottom View

• (tc) : Max. Case Temperature

※ Terminal Pin No. Assignment(TB1)

| Pin No. | Assignment |
|---------|------------|
| 1       | AC/L       |
| 2       | AC/N       |

※ Terminal Pin No. Assignment(TB3)

| Pin No. | Assignment | Pin No. | Assignment | Pin No. | Assignment |
|---------|------------|---------|------------|---------|------------|
| 1       | +FAN       | 3       | +NTC       | 5       | DIM+       |
| 2       | -FAN       | 4       | -NTC       | 6       | DIM-       |

◎ Pin1(+FAN) / Pin2(-FAN) is the Auxiliary DC output;it can be used to drive fan.

※ Terminal Pin No. Assignment(TB5)

| Pin No. | Assignment |
|---------|------------|
| 1       | +V         |
| 2       | -V         |

※ SYN. Connector(CN101/CN100):JST B2B-XH or equivalent

| Pin No. | Assignment | Mating Housing           | Terminal                           |
|---------|------------|--------------------------|------------------------------------|
| 1,3     | +          | JST XHP<br>or equivalent | JST SXH-001T-P0.6<br>or equivalent |
| 2,4     | -          |                          |                                    |

※ The following is only for Optional EO model:

## ■ LRN button description

LRN (Learn) Button:

Shortly press (around 2 second) the button to enter linking (pairing) / unlinking mode.

The LED lamp connected at the output of LCM starts toggling between 10% and 90% indicating that linking mode is active. Once activated, this mode stays active to provide time to link or unlink multiple switches. The mode will stop and bak to normal mode after 30 seconds if no wireless telegram from switch is received.

For the switch to be linked, click the "I" button (top button marked on the switch plastic or "I" symbol on the back of the switch 4 times quickly, In case the output is continuous 100% 4 seconds, it mean the switch is linked successfully.

The LED driver is now ready to accept new links on another switch.

In case a linked switch to be unlinked, please use the same action as described from the linking method above.

To exit linking / unlinking mode and return to normal operation, wait 30 seconds without doing anything or shortly press the button again.

In order to clear all linked switches and reset the LED driver to factory settings, please press and hold the button for 10 seconds.

## ■ Installation & Pairing

Hardware connection:

- 1.Connect the LED lamp to the driver.
- 2.Connect the driver to the AC mains.

There are two approaches for linking(pairing):

- 1.Using the LRN button on the driver

The instruction is in the LRN button description.

- 2.Using the NAVIGAN wireless software

Benefit to use NAVIGAN is more dimming parameters can be configured .

The software can be download in the website link below.

<http://www.navigan.com/>

After the software installation, insert the NWC300 into one of USB port from the computer.

For more details, please check the manual.



NWC300

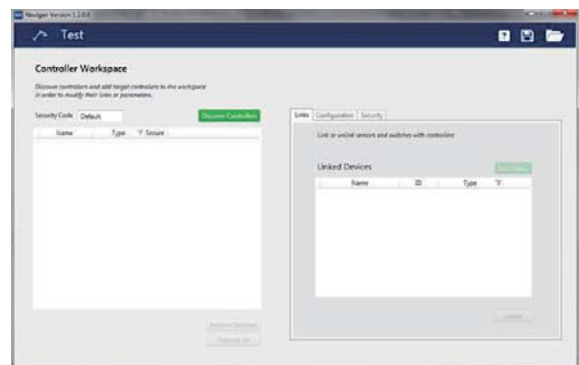
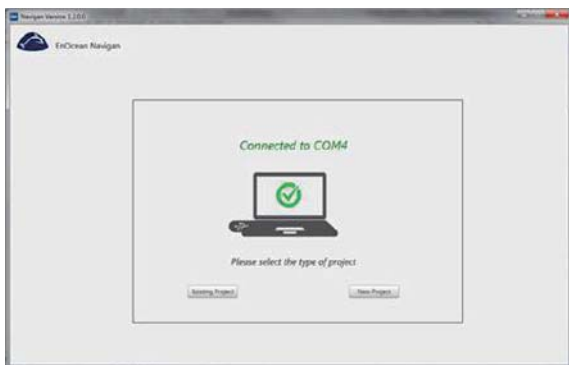



※The following is only for Optional EO model

Case No.LCM-60A Unit:mm

## MECHANICAL SPECIFICATION

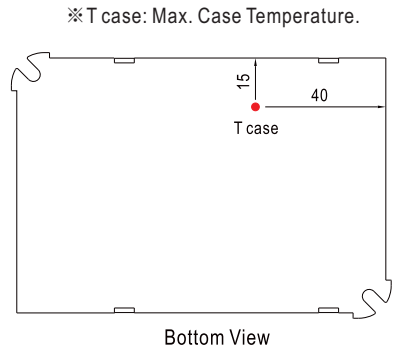
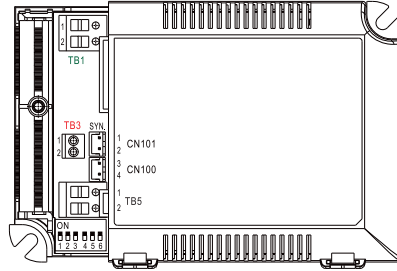
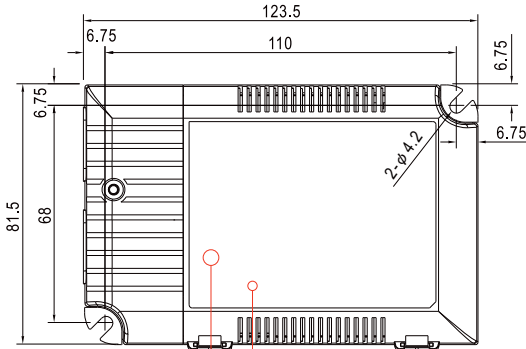

※T case: Max. Case Temperature.

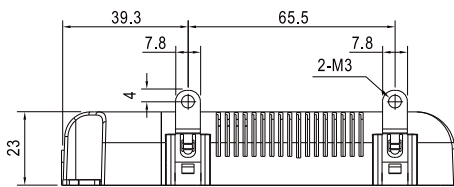

※ Terminal Pin No. Assignment(TB1)

| Pin No. | Assignment |
|---------|------------|
| 1       | AC/L       |
| 2       | AC/N       |

※ Terminal Pin No. Assignment(TB3)

| Pin No. | Assignment |
|---------|------------|
| 1       | +NTC       |
| 2       | -NTC       |

※ Terminal Pin No. Assignment(TB5)

| Pin No. | Assignment |
|---------|------------|
| 1       | +Vo        |
| 2       | -Vo        |

※ SYN. or DC 0-10V Dimming

Connector(CN101/CN100):JST B2B-XH or equivalent

| Pin No. | Assignment | Mating Housing           | Terminal                           |
|---------|------------|--------------------------|------------------------------------|
| 1,3     | +          | JST XHP<br>or equivalent | JST SXH-001T-P0.6<br>or equivalent |
| 2,4     | -          |                          |                                    |

■ Interoperable products / EnOcean Equipment Profile(EEP)

|                    |          |
|--------------------|----------|
| Support Equipment  | Telegram |
| Rocker Pad Switch  | F6-02-02 |
| Occupancy Sensor   | F5-07-01 |
| Occupancy Sensor   | A5-07-02 |
| Occupancy Sensor   | A5-07-03 |
| Light Level Sensor | A5-06-02 |
| Light Level Sensor | A5-06-03 |
| Central Controller | A5-38-08 |
| Demand Response    | A5-37-01 |

■ World Coverage Map

| COUNTRY/REGION           | STANDARD                              | FREQUENCY                       |
|--------------------------|---------------------------------------|---------------------------------|
| Aruba                    | Possibly R & TTE Directive            | 868 MHz-Confirm with test house |
| Australia / New Zealand  | N.A.                                  |                                 |
| Barbados                 | N.A.                                  | Note1                           |
| Bermuda                  | N.A.                                  | Note1                           |
| Bolivia                  | N.A.                                  | Note1                           |
| Brazil                   | ANATEL                                | 868 MHz                         |
| British Virgin Islands   | N.A.                                  | Note1                           |
| Cayman Islands           | Possibly R & TTE Directive            | 868 MHz                         |
| CEPT(European regional)* | EN 300 220                            | 868 MHz                         |
| Chile                    | Possibly R & TTE Directive            | 868 MHz                         |
| China                    | CNAS/MITT EN 300 220                  | 868 MHz                         |
| Colombia                 | Possibly ANATEL                       | 868 MHz                         |
| Ecuador                  | N.A.                                  | Note1                           |
| El Salvador              | Possibly R & TTE Directive            | 868 MHz                         |
| French Guiana            | ETSI EN 300 220                       | 868 MHz                         |
| Guatemala                | N.A.                                  | Note1                           |
| Hong Kong                | Possibly 315MHz                       | Note1                           |
| India                    | Possibly 315MHz                       | Note1                           |
| Israel                   | Possibly 315MHz                       | Note1                           |
| Jamaica                  | N.A.                                  | Note1                           |
| Japan 920**              | ARIB STD-T108                         | 928 MHz                         |
| Malaysia                 | SKMM WTS SRD / EN 300 220             | 868 MHz                         |
| Mexico                   | We believe Mexico does not accept FCC | 868 MHz                         |
| Nicaragua                | N.A.                                  | Note1                           |
| Peru                     | N.A.                                  | Note1                           |
| Panama                   | FCC CFR47 Part 15.249                 | 902 MHz                         |
| Russia                   | N.A.                                  |                                 |
| Singapore                | TS SRD / EN 300 220                   | 868 MHz                         |
| South Africa             | CASA / EN 300 220                     | 868 MHz                         |
| South Korea              | N.A.                                  |                                 |
| Suriname                 | N.A.                                  | Note1                           |
| Taiwan                   | Possibly 315 MHz                      | Note1                           |
| Trinidad & Tabago        | N.A.                                  | Note1                           |
| Turks & Caicos Islands   | Possibly R & TTE Directive            | 868 MHz                         |
| UAE                      | EN 300 220                            | 868 MHz                         |
| Uruguay                  | N.A.                                  | Note1                           |
| USA / Canada             | FCC CFR47 Part 15.249                 | 315 MHz, 902 MHz                |



## 35W Multiple-Stage Constant Current Mode LED Driver **LCM-40U** series

Note1: It is suggested to check with local accredited certification agency.

\*CEPT is the European regional organization dealing with postal and telecommunications issues and presently has 45 Members: Albania, Andorra, Austria, Azerbaijan, Belarus, Belgium, Bosnia and Herzegovina, Bulgaria, Croatia, Cyprus, Czech Republic, Denmark, Estonia, Finland, France, Germany, Greece, Hungary, Iceland, Ireland, Italy, Latvia, Liechtenstein, Lithuania, Luxembourg, Malta, Moldova, Monaco, Netherlands, Norway, Poland, Portugal, Romania, Russian Federation, San Marino, Serbia and Montenegro, Slovakia, Slovenia, Spain, Sweden, Switzerland, The former Yugoslav Republic of Macedonia, Turkey, Ukraine, United Kingdom, and Vatican.

\*\*In February 2012, Japanese regulatory body ARIB(Association of Radio Industries and Businesses) released new 920 MHZ frequency band for radio equipment, due to LTE rollout, The 950 MHZ frequency band will be obsolete by end of 2015.