

**Data sheet | Item number: 831-3606/108-000**

THT male header; 1.0 x 1.2 mm solder pin; straight; 100% protected against mismatching; Threaded flange; Pin spacing 7.62 mm; 6-pole; light gray

[www.wago.com/831-3606/108-000](http://www.wago.com/831-3606/108-000)

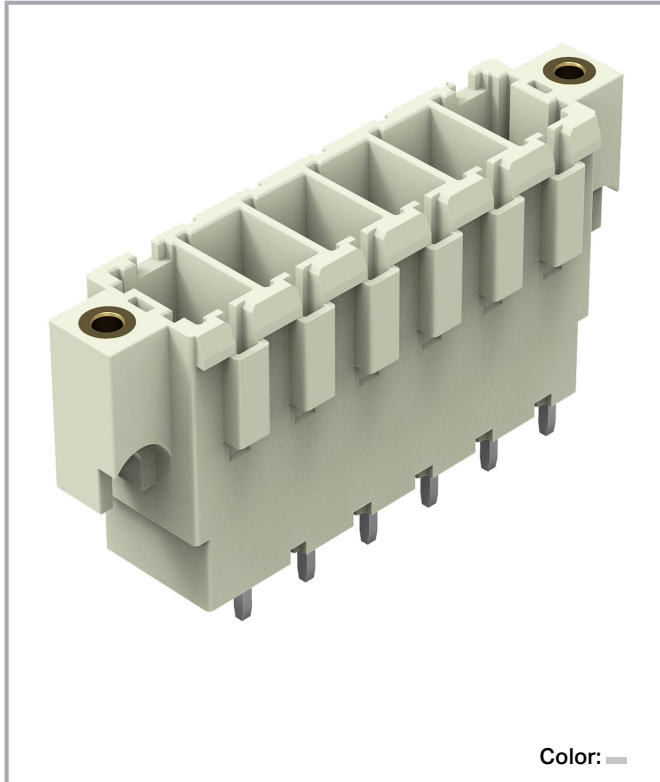

Color: —

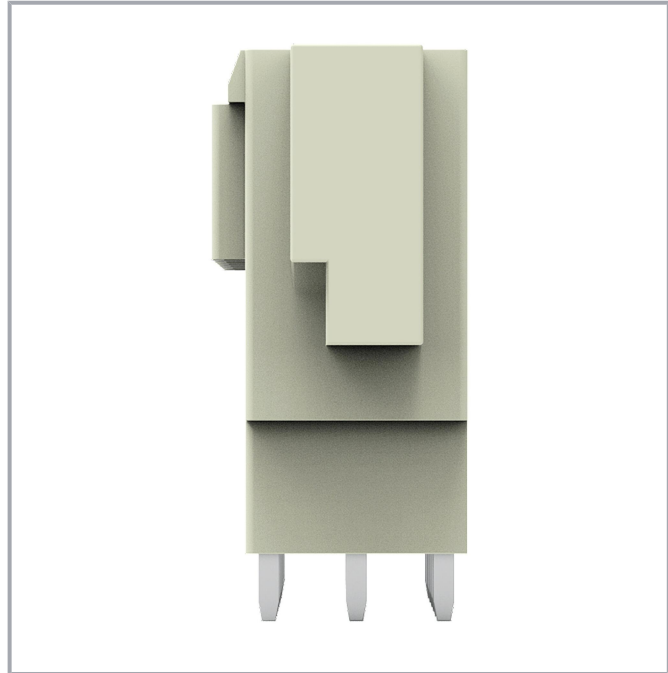

Subject to changes. Please also observe the further product documentation!

WAGO GmbH & Co. KG  
Hansastr. 27  
32423 Minden  
Phone: +49571 887-0 | Fax: +49571 887-169  
Email: [info.de@wago.com](mailto:info.de@wago.com) | Web: [www.wago.com](http://www.wago.com)

Do you have any questions about our products?  
We are always happy to take your call at +49 (571) 887-44222.

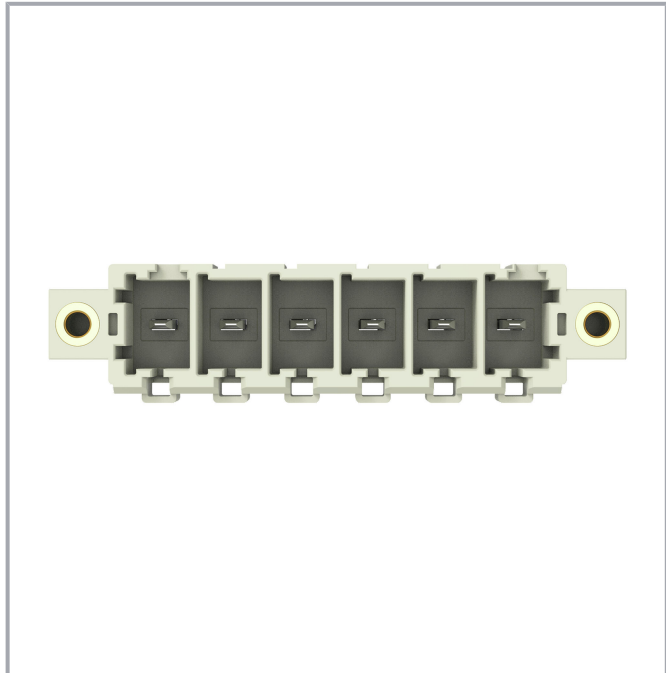
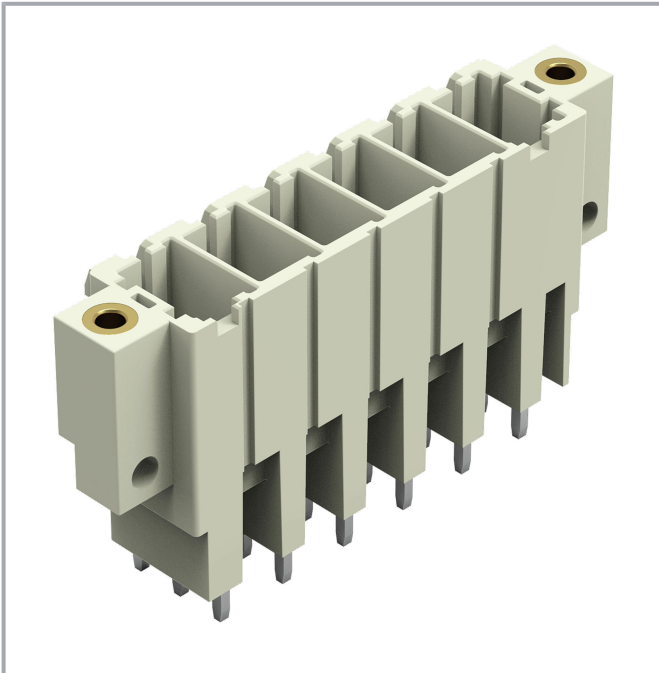

**Derating Curve**

1-conductor female connector (831-3102) with  
THT male header (831-3622)

Pin spacing: 7.62 mm / Conductor cross-section: 6 mm<sup>2</sup> "f-st"  
Based on: EN 60512-5-2 / Reduction factor: 0.8

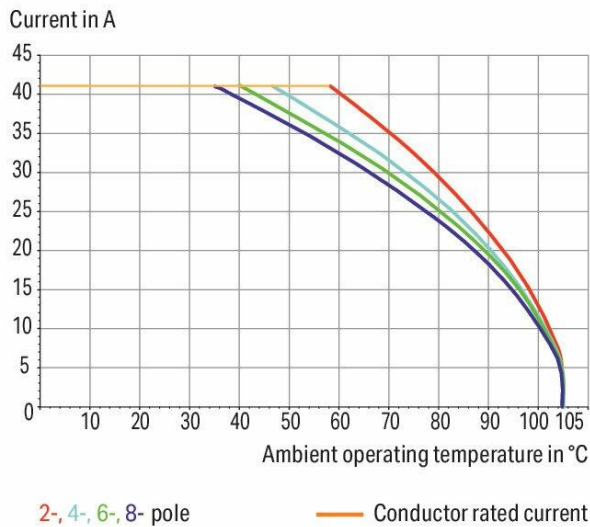

**Derating Curve**

1-conductor female connector (831-11xx) with  
THT male header (831-36xx)

Pin spacing: 7.62 mm / Conductor cross-section: 6 mm<sup>2</sup> "f-st"  
Based on: EN 60512-5-2 / Reduction factor: 0.8

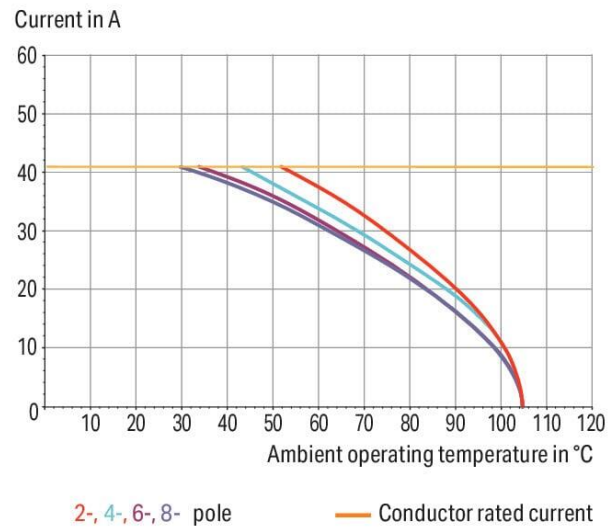

Subject to changes. Please also observe the further product documentation!

WAGO GmbH & Co. KG

Hansastr. 27

32423 Minden

Phone: +49571 887-0 | Fax: +49571 887-169

Email: [info.de@wago.com](mailto:info.de@wago.com) | Web: [www.wago.com](http://www.wago.com)

Do you have any questions about our products?

We are always happy to take your call at +49 (571) 887-44222.

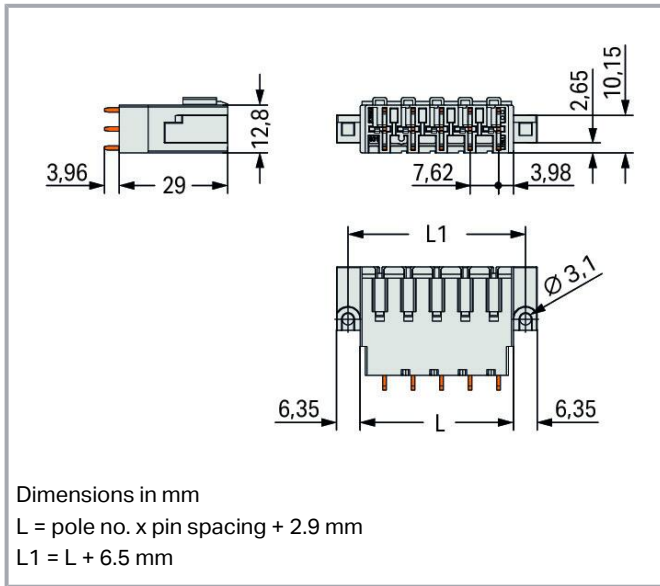

## Item description

- Male headers may be mounted horizontally or vertically via straight or angled solder pins
- Three solder pins per pole provide high electrical and mechanical stability
- 100 % protected against mismatching
- Coding via coding fingers

## Data

### Notes

#### Safety information

The *MCS – MULTI CONNECTION SYSTEM* includes connectors without breaking capacity in accordance with DIN EN 61984. When used as intended, these connectors must not be connected /disconnected when live or under load. When used as intended, these connectors must not be connected/disconnected when live or under load. The circuit design should ensure header pins, which can be touched, are not live when unmated.

#### Variants:

Other pole numbers  
 Protection against PCB mounting errors  
 Other versions (or variants) can be requested from WAGO Sales or configured at <https://configurator.wago.com/>.

## Electrical data

Subject to changes. Please also observe the further product documentation!



### Ratings per IEC/EN

Ratings per	IEC/EN 60664-1
Nominal voltage (III/3)	500 V
Rated impulse voltage (III/3)	6 kV
Rated voltage (III/2)	630 V
Rated impulse voltage (III/2)	6 kV
Nominal voltage (II/2)	1000 V
Rated surge voltage (II/2)	6 kV
Rated current	41 A
Legend (ratings)	(III / 2) $\triangleq$ Overvoltage category III / Pollution degree 2

### Ratings per UL 1059

Approvals per	UL 1059
Rated voltage UL (Use Group C)	300 V
Rated current UL (Use Group C)	42 A
Rated voltage UL (Use Group D)	600 V
Rated current UL (Use Group D)	5 A

### Ratings per CSA

Approvals per	CSA
Rated voltage CSA (Use Group C)	300 V
Rated current CSA (Use Group C)	41 A
Rated voltage CSA (Use Group D)	600 V
Rated current CSA (Use Group D)	5 A

### Connection data

Total number of potentials	6
Number of connection types	1
Number of levels	1

### Connection 1

Pole number	6
-------------	---

### Physical data

Pin spacing	7.62 mm / 0.3 inches
-------------	----------------------

Subject to changes. Please also observe the further product documentation!



Width	61.3 mm / 2.414 inches
Height	33 mm / 1.299 inches
Height from the surface	29 mm / 1.142 inches
Depth	14.8 mm / 0.583 inches
Solder pin length	4 mm
Solder pin dimensions	1 x 1.2 mm
Drilled hole diameter with tolerance	1.7 <sup>(+0.1)</sup> mm

## Mechanical Data

Variable coding	Yes
Anti-rotation protection	Yes

## Plug-in connection

Contact type (pluggable connector)	Male connector/plug
Connector (connection type)	for PCB
Mismating protection	Yes
Plugging without loss of pin spacing	No
Mating direction to the PCB	90 °
Locking of plug-in connection	Threaded flange

## PCB contact

PCB contact	THT
Solder pin arrangement	over the entire male connector (in-line)
Number of solder pins per potential	3

## Material Data

Note (material data)	Information on material specifications can be found here
Color	light gray
Material group	I
Insulation material	Polyamide (PA66)
Flammability class per UL94	V0
Contact material	Electrolytic copper (E <sub>Cu</sub> )
Contact plating	Tin
Weight	19.8 g

Subject to changes. Please also observe the further product documentation!

## Environmental requirements

Limit temperature range	-60 ... +105 °C
Processing temperature	-35 ... +60 °C

## Commercial data



ETIM 8.0	EC002637
ETIM 7.0	EC002637
PU (SPU)	24 pcs
Country of origin	PL
GTIN	4066966090895
Customs tariff number	85366990990

## Environmental Product Compliance

RoHS Compliance Status	Compliant, No Exemption
------------------------	-------------------------

## Approvals / Certificates

### General approvals

Logo	Approval	Additional Approval Text	Certificate name
	<b>CB</b> DEKRA Certification B.V.	IEC 61984	NL-61360 /M1
	<b>KEMA/KEUR</b> DEKRA Certification B.V.	EN 61984	71-116057
	<b>UR</b> Underwriters Laboratories Inc.	UL 1059	E45172
	<b>UR</b> Underwriters Laboratories Inc.	UL 1059	E45172

### Declarations of conformity and manufacturer's declarations

Logo	Approval	Additional Approval Text	Certificate name
	<b>Railway</b> WAGO GmbH & Co. KG	-	Railway Ready

Subject to changes. Please also observe the further product documentation!



## Counterpart



Item no. **831-3106/107-000**

1-conductor female connector; Push-in CAGE CLAMP®; 10 mm<sup>2</sup>; Pin spacing 7.62 mm; 6-pole; 100% protected against mismatching; Screw flange; 10,00 mm<sup>2</sup>; light gray

[www.wago.com/831-3106/107-000](http://www.wago.com/831-3106/107-000)

## Downloads

### Documentation

#### Additional Information

Technical Section	2019 Apr 3	pdf	Download
Technical explanations		2.0 MB	

## CAD/CAE-Data

### CAD data

2D/3D Models 831-3606/108-000	URL	Download
-------------------------------	-----	----------

### CAE data

ZUKEN Portal 831-3606/108-000	URL	Download
-------------------------------	-----	----------

## Environmental Product Compliance

### Compliance Search

Environmental Product Compliance 831-3606/108-000	URL	Download
---	-----	----------

THT male header; 1.0 x 1.2 mm solder pin; straight; 100% protected against mismatching; Threaded flange; Pin spacing 7.62 mm; 6-pole; light gray

## Installation Notes

### Coding

Subject to changes. Please also observe the further product documentation!

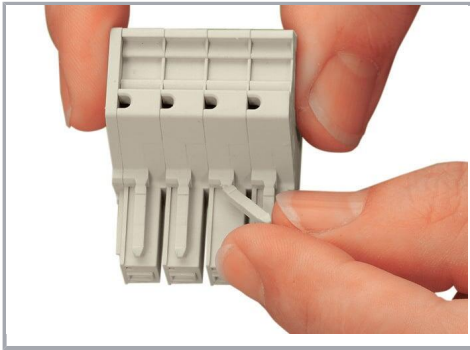

Break or cut off coding pin from female connector.

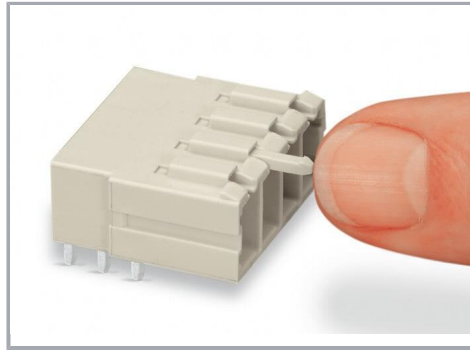

Insert coding pin into male header (break first) until it engages.

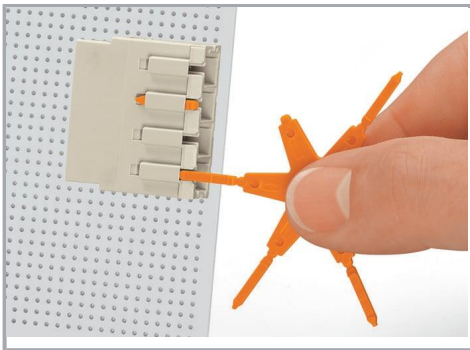

Coding a THT male header by inserting a coding pin.

## Product family

**MCS MAXI 6**

[Show all products from the family](#)

Subject to changes. Please also observe the further product documentation!