

GSM I-Bar Adhesive Antenna



AEACCA115021-S850

115.6 x 21.7 x 5.8mm

Pb | RoHS/RoHS II Compliant
MSL = NOT APPLICABLE

FEATURES

- Adhesive mount
- Gain of 2dBi
- VSWR of 2.0
- Low profile 5.8mm
- Multiband 824-960MHz and 1710MHz-2170MHz
- Blade type GSM antenna covering GSM-850, GSM-900, DCS-1800, PCS-1900 bands

APPLICATIONS

- IoT applications
- M2M
- GSM applications
- Telematics
- Remote Technology/monitoring
- POS terminals

ELECTRICAL SPECIFICATIONS

Parameters	Min.	Typ.	Max.	Units	Note
Frequency Range		824~960 / 1710~2170		MHz	
VSWR			2.0		
Polarization Model	Linear				
Impedance		50		Ω	
Gain		2		dBi	
Operating Temperature	-40		+85	$^{\circ}\text{C}$	
Input Power			10	W	

RETURN - LOSS CHARACTERISTICS

S11 Return-Loss

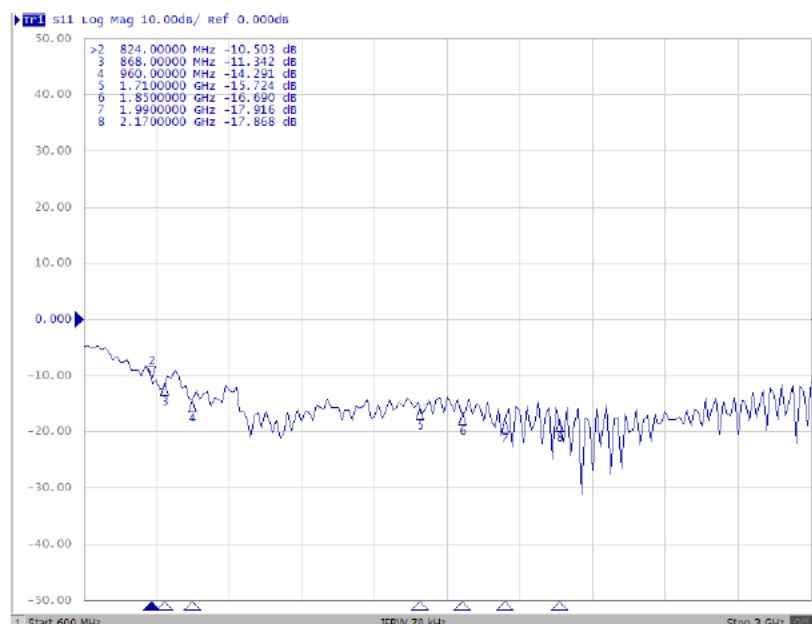

GSM I-Bar Adhesive Antenna



AEACCA115021-S850

115.6 x 21.7 x 5.8mm
Pb | **RoHS/RoHS II Compliant**
MSL = NOT APPLICABLE

RADIATION PATTERNS

XY Plane

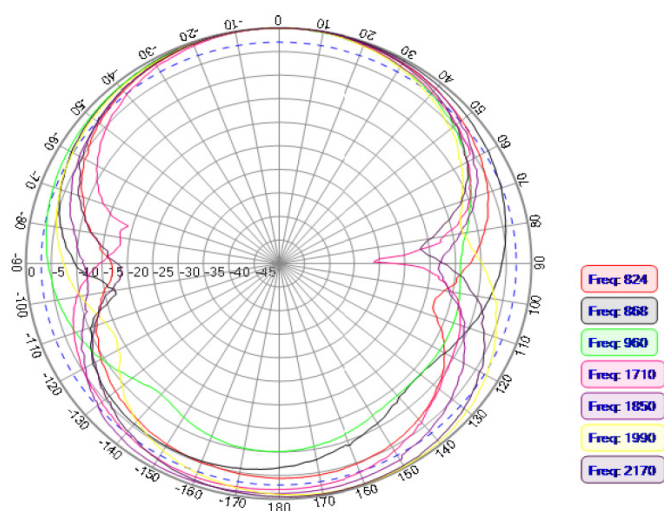

XZ Plane

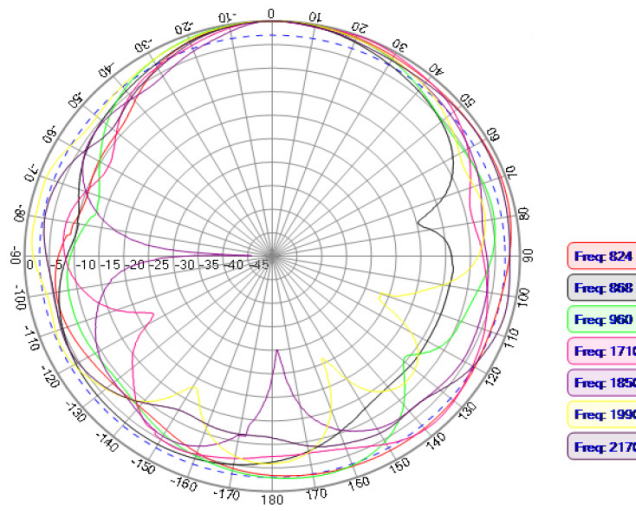

YZ Plane

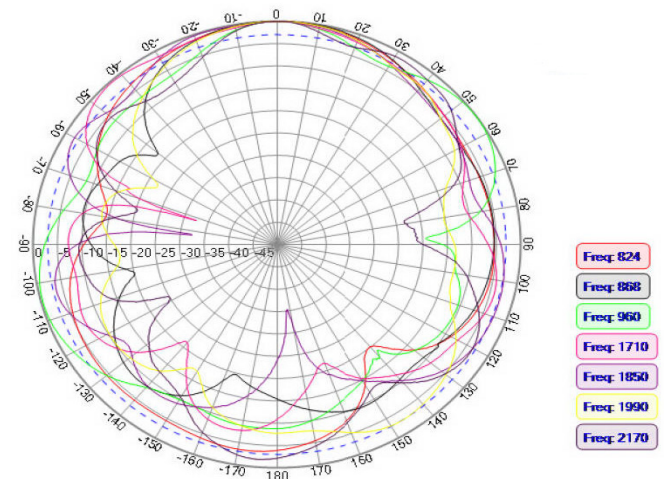

824 MHz

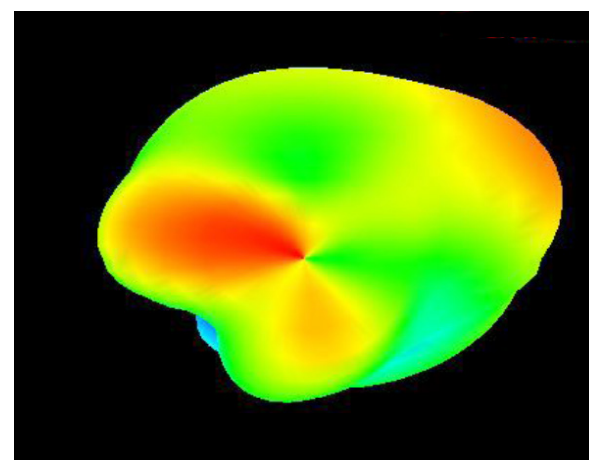

1710 MHz

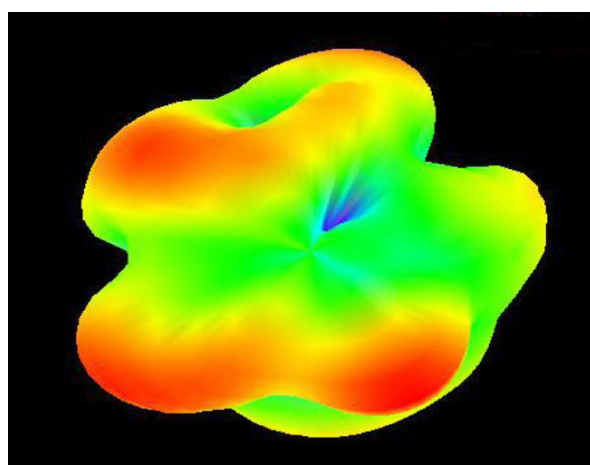

2170 MHz

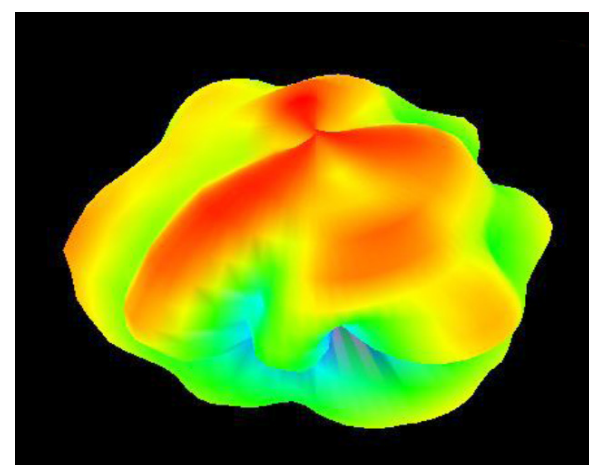

Frequency (MHz)	824	1710	2170
Peak Gain (dBi)	-1.01	-0.50	0.41
Efficiency (%)	60	57	57

GSM I-Bar Adhesive Antenna



AEACCA115021-S850

115.6 x 21.7 x 5.8mm
Pb | **RoHS/RoHS II Compliant**
MSL = NOT APPLICABLE

DIMENSIONS:

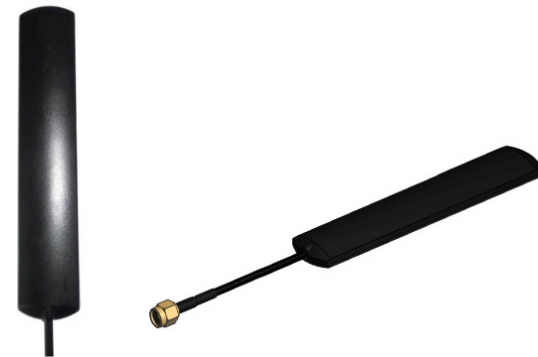
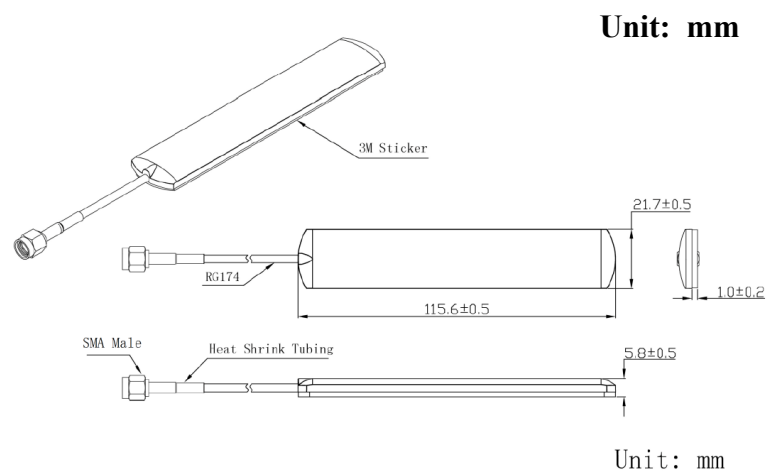

Parameters	Description
Cable Length	3.00 m
RF Cable	RG174
RF Connector	SMA
Radome Material	ABS
Mounting Type	Adhesive

PACKAGING:

Each 700 x 320 x 155 mm size carton includes 250 pcs antenna, 13kgs/carton.

