

Figure 1.1. Top View of AHV24V9KV1MAW



Figure 1.2. Side View



Figure 1.3. Side View

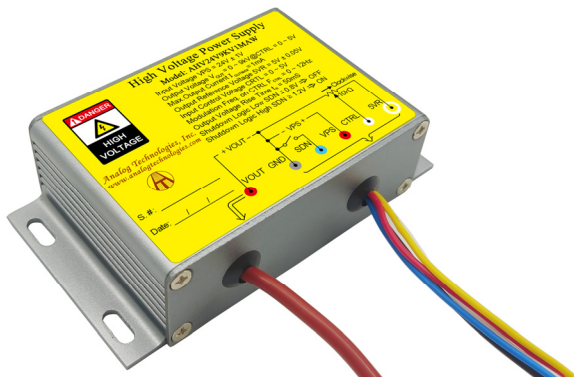

Figure 1.4. Side View

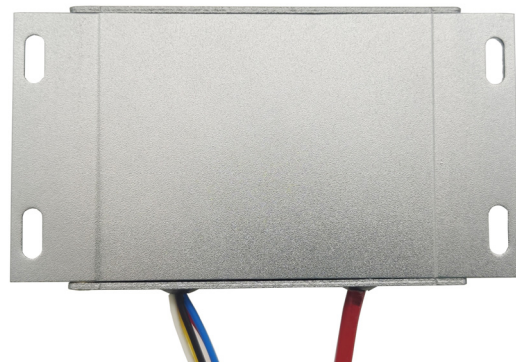

Figure 1.5. Bottom View



FEATURES

- Input Power Voltage: 24V ± 1V
- Input Current Range: 40mA to 500mA
- Output Voltage: 0 to 9kV@CTRL = 0 to 5V
- Max. Output Current: 1mA
- Reference Voltage: 5V ± 0.05V
- Input Control Voltage: 0 to 5V
- Full Span Modulation on Output Voltage
- Electronic Shutdown Control

APPLICATIONS

This power module, AHV24V9KV1MAW, is designed for achieving DC-DC conversion from low voltage to high voltage as a power supply source which is widely used in scientific research and other fields including:

- X-ray Machine
- Spectral Analysis
- Nondestructive Inspection
- Semiconductor Manufacturing Equipment
- CRT Monitor Test
- Particle Accelerator
- Capillary Electrophoresis
- Particles Injection
- Semiconductor Technology
- Physical Vapor Phase Deposition
- Radio Frequency Amplification
- Electrospinning Preparation of Nanofiber
- Glass / Fabric Coating
- DC Reactive Magnetron Sputtering
- Cyclotron Accelerator

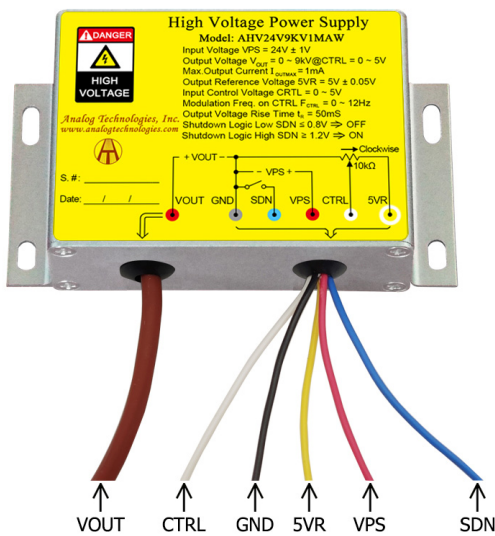

Figure 2. The Connecting Lead Wires of AHV24V9KV1MA

Table 1. Pin Names, Colors, Functions and Specifications.

No.	Name	Color	Type	Description	Min.	Typ.	Max.
1	SDN	Blue	Digital input	Shutdown logic low	0V		0.8V
				Shutdown logic high	1.2V		5V
2	5VR	Yellow	Analog output	Reference voltage		5V	
3	CTRL	White	Analog input	Regulation	0V		5V
4	VPS	Red	Power input	Input voltage		24V	
5	GND	Black	Ground for analog, digital and power signals.	Ground electrode		0V	
6	VOUT	Brown	Power output	Output high voltage	0V		9kV



DESCRIPTION

Figure 2 shows the connecting wires of AHV24V9KV1MAW, of which their detail information given in Table 1. The output voltage can be set to a constant value by connecting the CTRL port to the central tap of a POT (Potentiometer) or modulated by an AC signal ranging from 0V to 5V corresponding to 0V to 9kV proportionally at the output VOUT port as shown in Figure 3 and Figure 4 respectively.

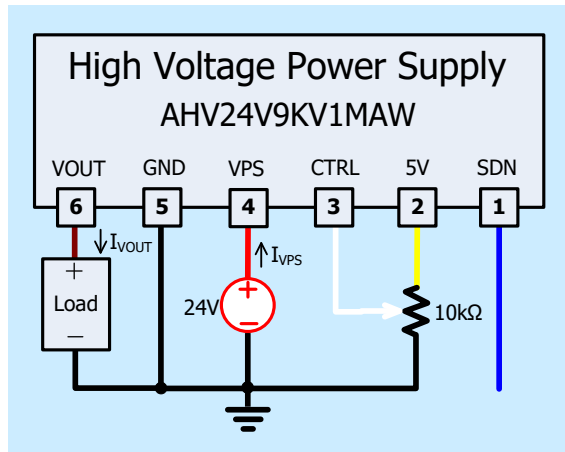

Figure 3. Setting Output to be a Constant Voltage

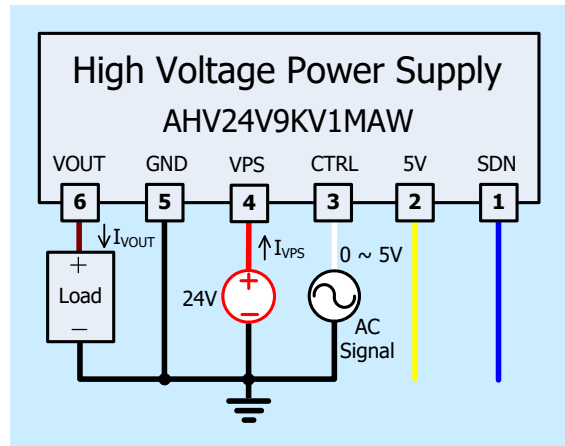

Figure 4. Modulating Output by an AC Signal Source

Please note that the modulation signal must have a low frequency  $\leq 10\text{Hz}$  and the value range must be  $0\text{V} \leq V_{CTRL} \leq 5\text{V}$ . The equivalent input circuit for the CTRL is shown in Figure 5.

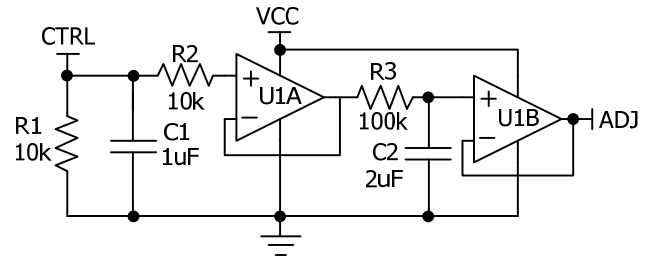

Figure 5. The Equivalent Circuit for CTRL Port

To shutdown AHV24V9KV1MAW, pull down SDN pin to  $< 0.8\text{V}$ ; to turn it on, leave SDN pin unconnected or pull it  $> 1.2\text{V}$ . The maximum voltage allowed on the SDN pin is 5V. The equivalent circuit for SDN port is shown in Figure 6.

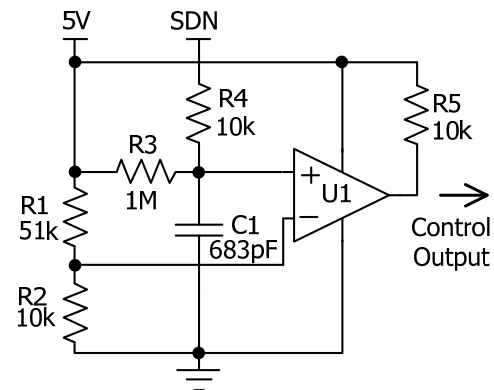

Figure 6. The Equivalent Circuit for SDN Port

USING AHV24V9KV1MAW

This high voltage power supply must be mounted tightly onto a metal plate, ideally, thus expanding its heating sinking capacity of the metal enclosure. Sufficient ventilation must be provided to keep the power supply surface temperature under  $55^\circ\text{C}$ .

SAFETY PRECAUTIONS

Although AHV24V9KV1MAW high voltage power supply comes with an over current protection circuit, a short circuit at the output should always be avoided. Make sure the high voltage wire for connecting VOUT node has sufficient insulation capability with its surrounding objects.



**SPECIFICATIONS**

**Table 2. Characteristics. T<sub>A</sub> = 25°C, unless otherwise noted.**

Parameter	Symbol	Test Conditions	Min.	Typ.	Max.	Unit/Note
Input Power Voltage	V <sub>VPS</sub>		23	24	25	V
Input Power Quiescent Current	I <sub>VPS_QC</sub>	I <sub>VOUT</sub> = 0mA	40	50	60	mA
Input Power Current at Full Load	I <sub>VPS_FL</sub>	I <sub>VOUT</sub> = 1.0mA	400	500	600	mA
Input Power Current at Shutdown	I <sub>VPS_SHDN</sub>	T <sub>A</sub> = -10°C ~ 55°C		15		mA
Power Supply Rejection Ratio	PSRR <sup>(1)</sup>	V <sub>VPS</sub> = 23V ~ 25V V <sub>CTRL</sub> = V <sub>5VR</sub> = 5V V <sub>VOUT</sub> = 9kV I <sub>VOUT</sub> = 1.0mA		TBD		dB
Modulation Voltage Range Frequency on CTRL	f <sub>CTRL</sub>		0		12	Hz
Shutdown Port Current	I <sub>SDNL</sub>	V <sub>SDNL</sub> < 0.8V	-5		-4.2	µA
	I <sub>SDNH</sub>	1.2V < V <sub>SDNL</sub> < 5V	0		3.8	µA
Shutdown Voltage Logic Low	V <sub>SDNL</sub>		0		0.8	V
Shutdown Voltage Logic High	V <sub>SDNH</sub>		1.2		5	V
Output Voltage	V <sub>VOUT</sub>	I <sub>VOUT</sub> = 0 ~ 1.0mA	0		9000	V
Output Current Range	I <sub>VOUTMAX</sub>	V <sub>VPS</sub> = 23V ~ 25V	0		1.0	mA
Reference Voltage Output Range	V <sub>5VR</sub>	T <sub>A</sub> = -10°C ~ 55°C I <sub>5VR</sub> ≤ 5mA	4.98	5	5.02	V
Output Load Range			9		∞	MΩ
Output Voltage Ripple	V <sub>VOUT_RP</sub>	Bandwidth = 1MHz R <sub>LOAD</sub> = 9 MΩ		≤4.5		V <sub>P-P</sub>
Output Voltage Ripple Frequency	f <sub>VOUT_RP</sub>			TBD		Hz
Output Voltage Temperature Coefficient	TCV <sub>VOUT</sub> <sup>(2)</sup>	V <sub>VPS</sub> = 24V V <sub>CTRL</sub> = V <sub>5VR</sub> = 5V V <sub>VOUT</sub> = 9kV I <sub>VOUT</sub> = 1mA T <sub>A</sub> = -10°C ~ 55°C		≤0.01		%/°C
Output Voltage Range v.s. Temperature	V <sub>VOUT(T)</sub>	V <sub>VPS</sub> = 24V V <sub>CTRL</sub> = V <sub>5VR</sub> = 5V V <sub>VOUT</sub> = 9kV I <sub>VOUT</sub> = 1mA T <sub>A</sub> = -10°C ~ 55°C	0.99V <sub>VOUT</sub>	V <sub>VOUT</sub>	1.01V <sub>VOUT</sub>	V
Output Voltage Drift	Short Term Drift	$\frac{ \Delta V_{VOUT} }{V_{VOUT}}$ Δt (min)		≤0.5		%/min
	Long Term Drift	$\frac{ \Delta V_{VOUT} }{V_{VOUT}}$ Δt (h)		≤1		%/h



Output Voltage Rise Time	$t_r$	$V_{VOUT}(t_1) = 900V$ $V_{VOUT}(t_2) = 8100V$ No-Load	30	ms	
		$V_{VOUT}(t_1) = 900V$ $V_{VOUT}(t_2) = 8100V$ $R_{Load} = 9 M\Omega$	TBD	ms	
Output Voltage Fall Time	$t_f$	$V_{VOUT}(t_2) = 8100V$ $V_{VOUT}(t_3) = 900V$ No-Load	100	ms	
		$V_{VOUT}(t_2) = 8100V$ $V_{VOUT}(t_3) = 900V$ $R_{Load} = 9 M\Omega$	TBD	ms	
Mean Time Between Failure	MTBF		TBD	h	
Instantaneous Short Circuit Current at the Output	$I_{VOUT\_SC}$		$\leq 500$	mA	
Load Regulation	$\frac{ \Delta V_{VOUT}/V_{VOUT} }{\Delta I_{VOUT}}$	$V_{VOUT} = 9kV$ $I_{VOUT} = 1mA$	$\leq 0.05$	%/mA	
Full Load Efficiency	$\eta^{(3)}$	$V_{VPS} = 24V$ $V_{VOUT} = 9kV$ $I_{VOUT} = 1mA$	$\geq 80$	%	
Operating Temperature Range	$T_{opr}$		-10	55 °C	
Storage Temperature Range	$T_{stg}$		-20	85 °C	
Thermal resistance housing-ambient	$\theta_{HA}^{(4)}$	$V_{VPS} = 24V$ $V_{CTRL} = V_{5VR} = 5V$ $V_{VOUT} = 9kV$ $I_{VOUT} = 1mA$	TBD	°C/W	
External Dimensions			82×55×28		mm
			3.23×2.17×1.10		inch
Weight			210	g	
			0.46	lbs	
			7.4	Oz	

Note 1:  $PSRR = 20 \log_{10} \frac{\Delta V_{VOUT}/V_{VOUT}}{\Delta V_{VPS}/V_{VPS}}$  (dB)

$\Delta V_{VOUT} = V_{VOUT}(V_{VPS} = 24.5V) - V_{VOUT}(V_{VPS} = 23.5V)$ ,  $V_{VOUT}(V_{VPS} = 24.5V) = V_{VOUT}(V_{VPS} = 24V)$   
 $\Delta V_{VPS} = 24.5V - 23.5V$ ,  $V_{VPS} = 24V$

Note 2:  $TCV_{VOUT} = \frac{|\Delta V_{VOUT}|}{V_{VOUT} \times \Delta T}$

Note 3:  $\eta = \frac{V_{VOUT} \times I_{VOUT}}{V_{VPS} \times I_{VPS}}$



### TESTING DATA

Test conditions:  $V_{VPS} = 24V$ ,  $T_A = 25^{\circ}C$ ,  $R_{LOAD} = 9M\Omega$

#### DC Testing

The measured output voltage,  $V_{VOUT}$ , corresponding to the control port input voltage,  $V_{CTRL}$ , is shown in Figure 7.

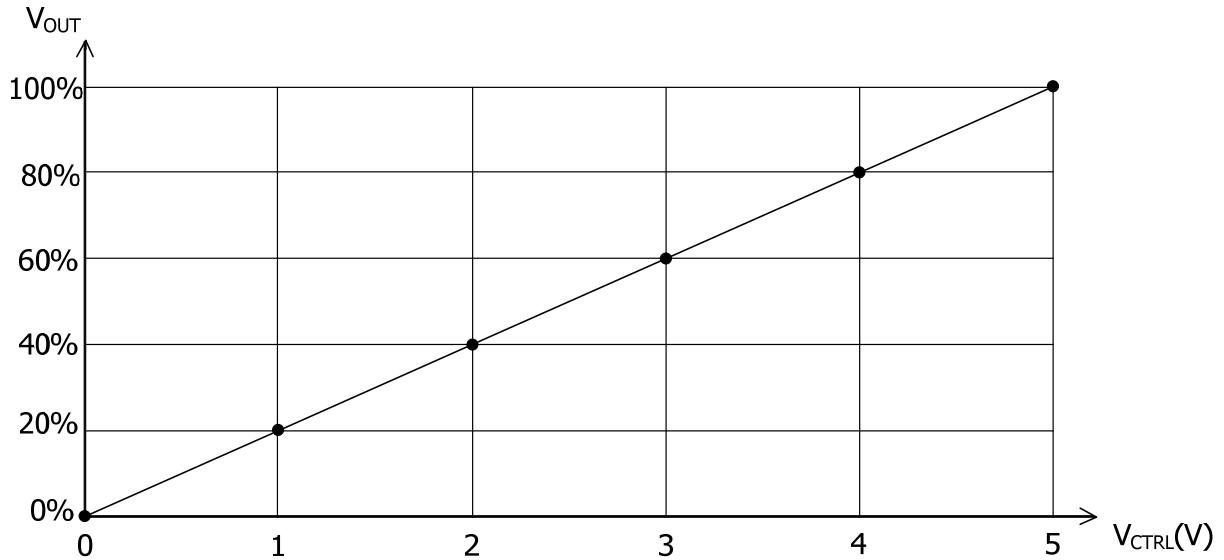

Figure 7.  $V_{CTRL}$  vs.  $V_{VOUT}$

#### AC Testing

To test the analog modulation function, a triangle and sine-wave voltage signals are applied to the CTRL port as the input source signal respectively. Figure 8 and 9 show both the input signal and the output signal waveforms when using the triangle and sine-wave signals at the CTRL port respectively.

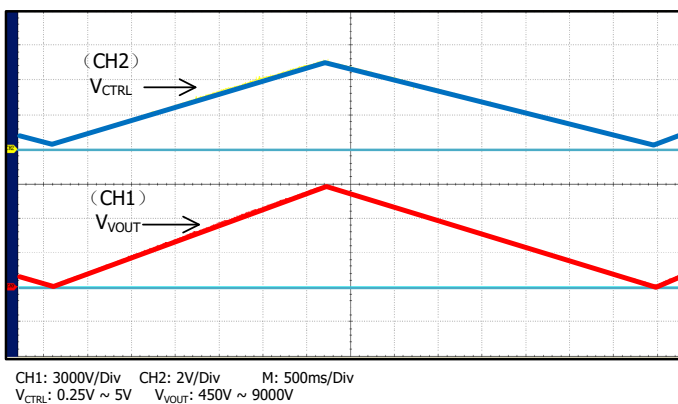

Figure 8. Input vs. Output Waveforms for Triangle Wave Control

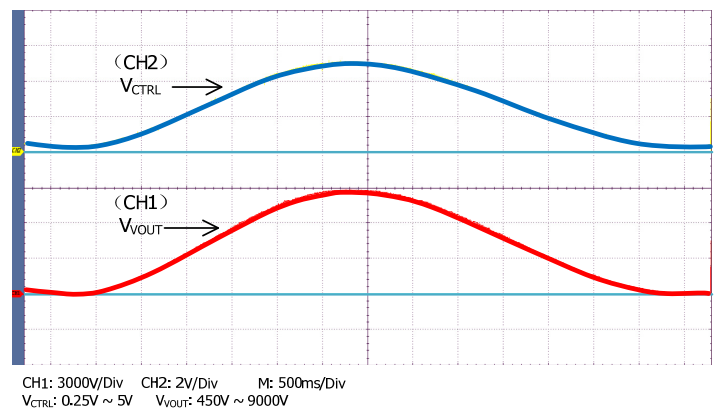

Figure 9. Input vs. Output Waveforms for Sine Wave Control



To test the rise and fall times at the output, a step function signal is applied to the CTRL port. The testing results are shown in Figure 10, Figure 11, and Figure 12. As shown in Figure 11 and Figure 12, a square wave of 0.25V ~ 5V, f = 0.10Hz, is applied to CTRL port, the output waveform fall time is measured to be about 100ms and the rise time is about 30ms. These two values are not the same, that is because on the rising trail, the power supply injects a current to the load; while on the falling trail, the best the power supply can do is to stop its output current and let the load resistor drain the output filtering capacitor to a lower voltage, and the draining current is much smaller than the injection current.

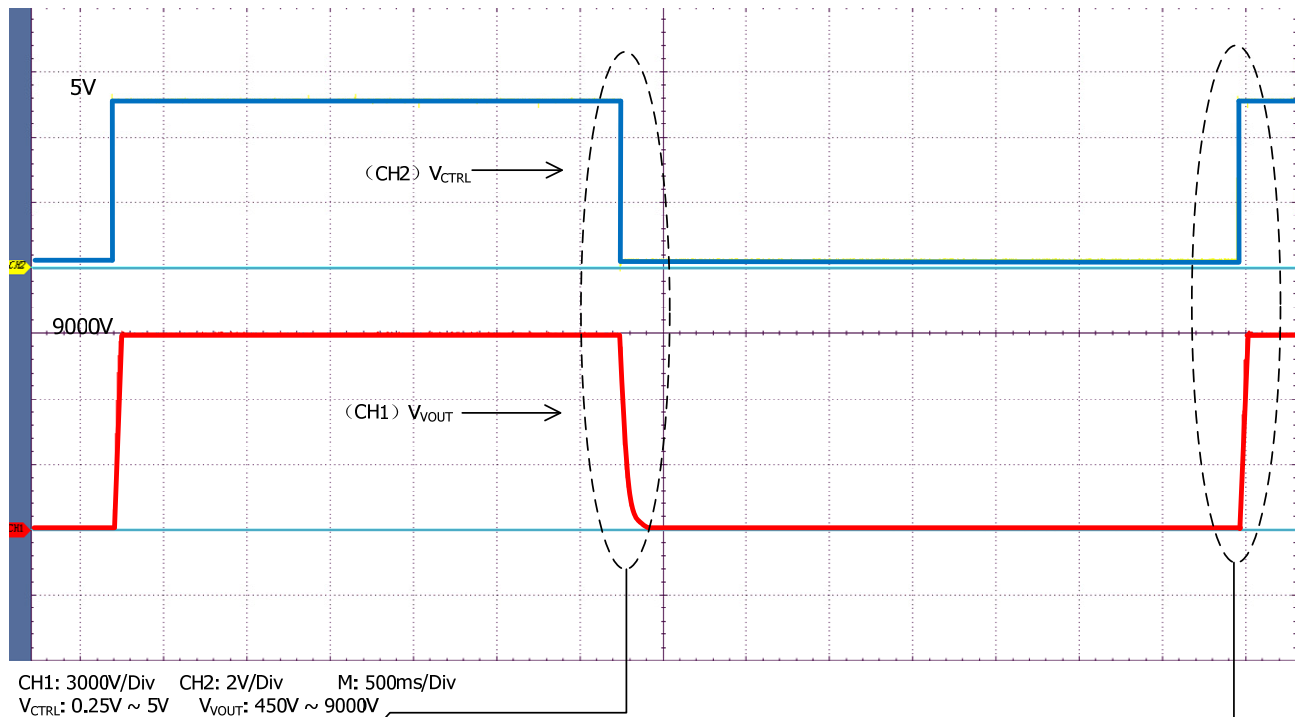

Figure 10. Input vs. Output Waveforms for Square Wave Control

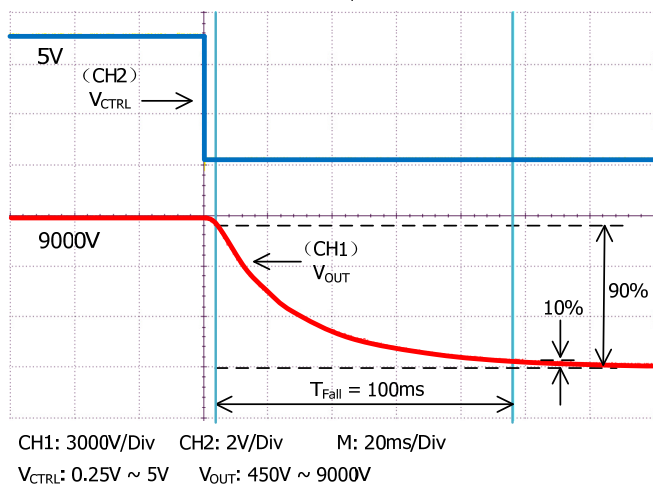

Figure 11. Falling Trail for Large Signal Response

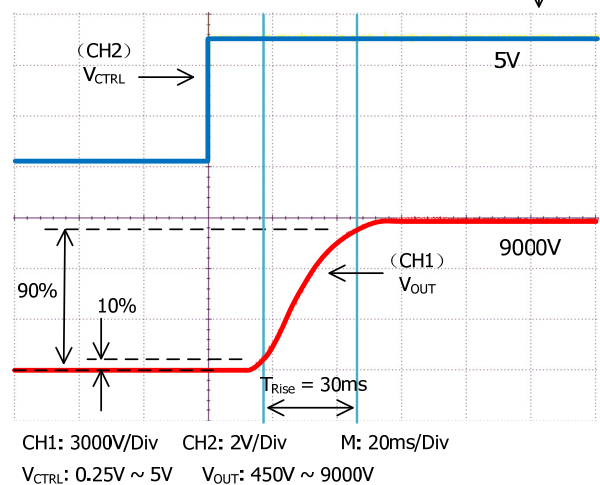
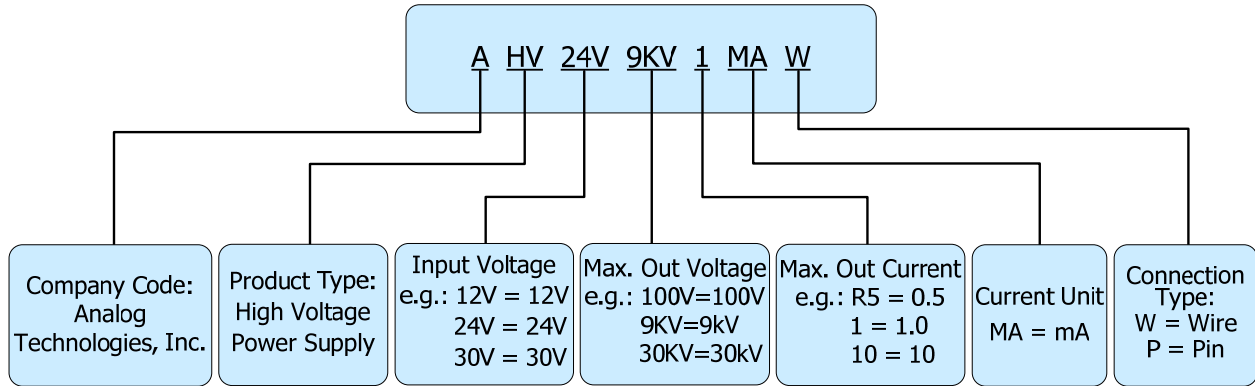

Figure 12. Rising Trail for Large Signal Response



NAMING PRINCIPLE



Naming Principle of AHV24V9KV1MAW

DIMENSIONS

Connecting Lead Wire Sizes and Lengths

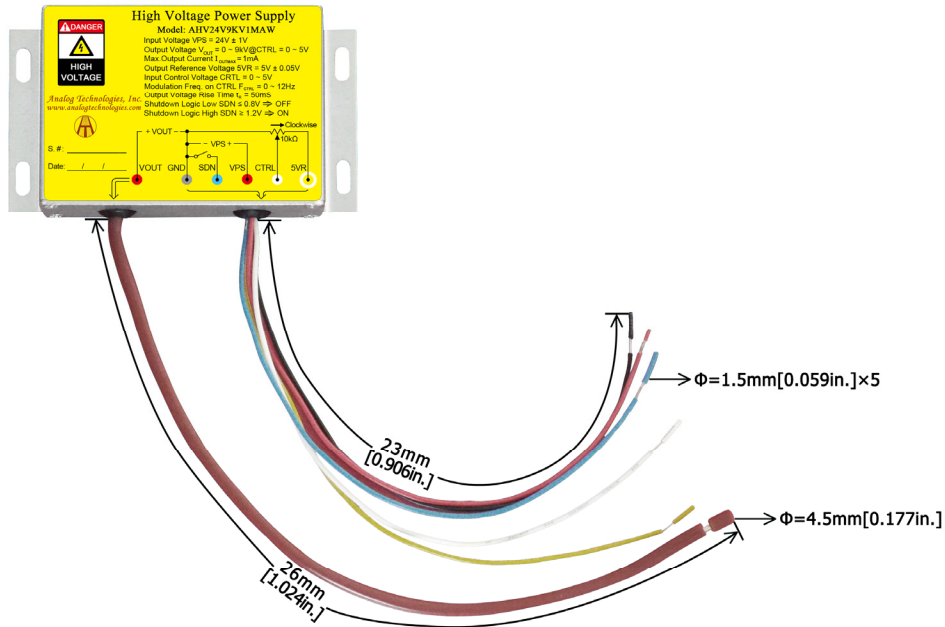

Figure 13. Connecting Lead Wires of AHV24V9KV1MAW

Lead Wires	Diameter		Length	
	mm	inch	mm	inch
Thick brown lead wire	4.5	0.177	26 ± 1	1.024 ± 0.039
Yellow, red, blue, black and white lead wires	1.5	0.059	23 ± 1	0.906 ± 0.039





Outline Dimensions



Figure 14. Outline Dimensions

ORDERING INFORMATION

Quantity	1~9pcs	10~49pcs	50~99pcs	≥100pcs
AHV24V9KV1MAW	\$179	\$169	\$159	\$149



## NOTICE

1. ATI warrants performance of its products for one year to the specifications applicable at the time of sale, except for those being damaged by excessive abuse. Products found not meeting the specifications within one year from the date of sale can be exchanged free of charge.
2. ATI reserves the right to make changes to its products or to discontinue any product or service without notice, and advise customers to obtain the latest version of relevant information to verify, before placing orders, that the information being relied on is current and complete.
3. All products are sold subject to the terms and conditions of sale supplied at the time of order acknowledgment, including those pertaining to warranty, patent infringement, and limitation of liability. Testing and other quality control techniques are utilized to the extent ATI deems necessary to support this warranty. Specific testing of all parameters of each device is not necessarily performed, except those mandated by government requirements.
4. Customers are responsible for their applications using ATI products. In order to minimize risks associated with the customers' applications, adequate design and operating safeguards must be provided by the customers to minimize inherent or procedural hazards. ATI assumes no liability for applications assistance or customer product design.
5. ATI does not warrant or represent that any license, either express or implied, is granted under any patent right, copyright, mask work right, or other intellectual property right of ATI covering or relating to any combination, machine, or process in which such products or services might be or are used. ATI's publication of information regarding any third party's products or services does not constitute ATI's approval, warranty or endorsement thereof.
6. IP (Intellectual Property) Ownership: ATI retains the ownership of full rights for special technologies and/or techniques embedded in its products, the designs for mechanics, optics, plus all modifications, improvements, and inventions made by ATI for its products and/or projects.