

## SURI-RS

~6° real spot beam with holder

### SPECIFICATION:

Dimensions	Ø 37.8 mm
Height	23.9 mm
Fastening	pin, screw
ROHS compliant	yes ⓘ

### MATERIALS:

Component	Type	Material	Colour	Finish
C16197_SURI-RS	Single lens	PMMA	clear	
C16192_GABRIELLA-MIDI-HLD	Holder	PC	black	

### ORDERING INFORMATION:

#### Quantities for one set:

Single lens	1
Holder	1



Component		Qty in box	MOQ	MPQ	Box weight (kg)
C16197_SURI-RS	Single lens	500	100	50	7.4
» Box size: 476 x 273 x 292 mm					
C16192_GABRIELLA-MIDI-HLD	Holder	500	100	50	3.6
» Box size: 476 x 273 x 292 mm					

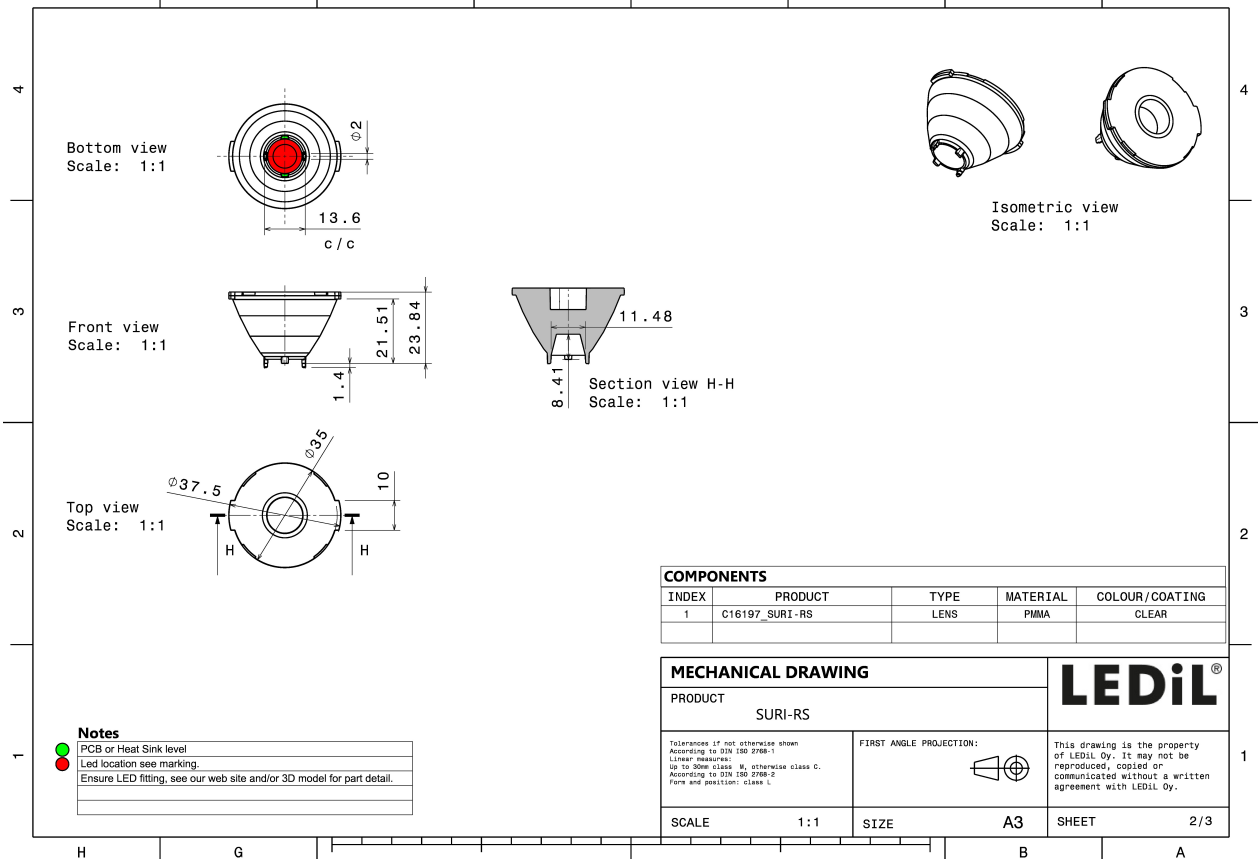
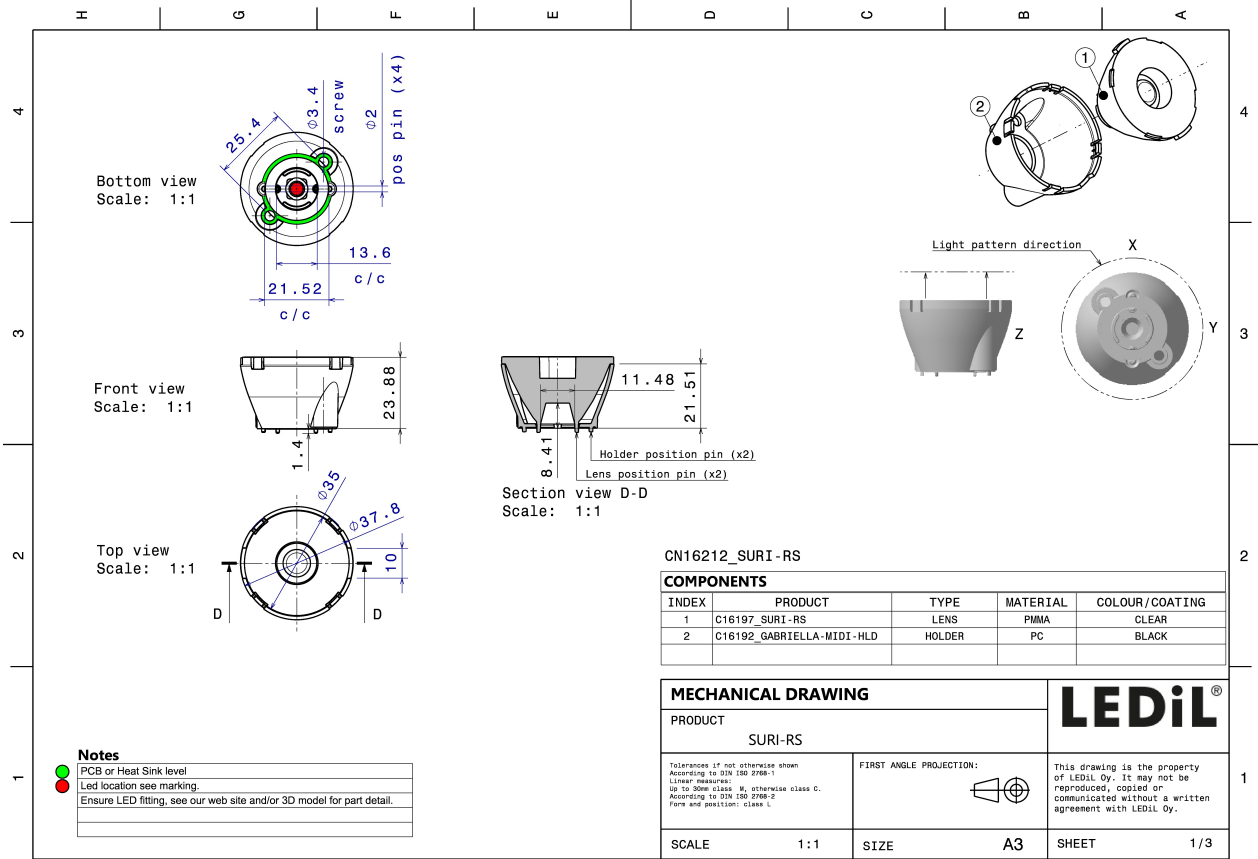

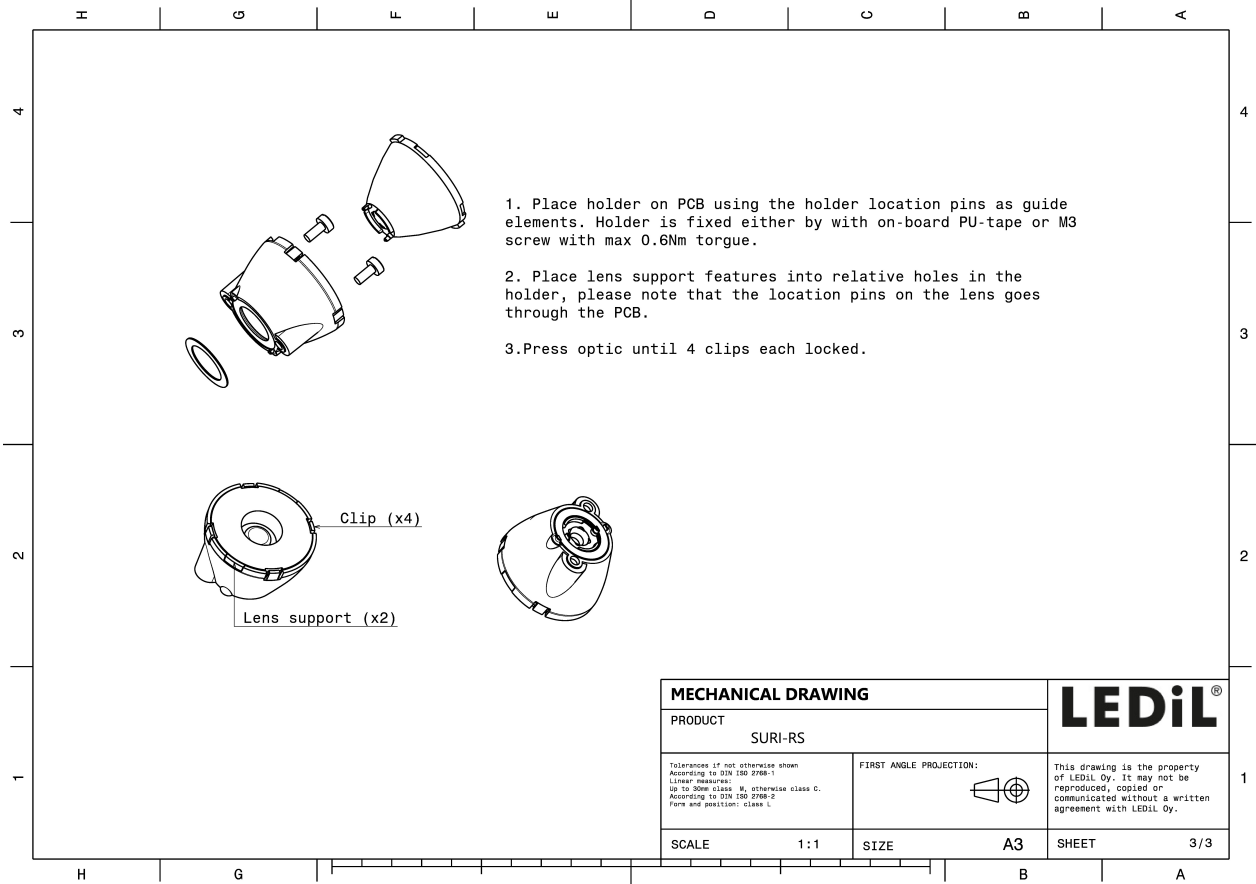

See also our general installation guide: [www.ledil.com/installation\\_guide](http://www.ledil.com/installation_guide)



### OPTICAL RESULTS (MEASURED):

#### CREE LED

LED XHP70.2  
 FWHM / FWTM 20.0° / 32.0°  
 Efficiency 88 %  
 Peak intensity 6.6 cd/lm  
 LEDs/each optic 1  
 Light colour White  
 Required components:

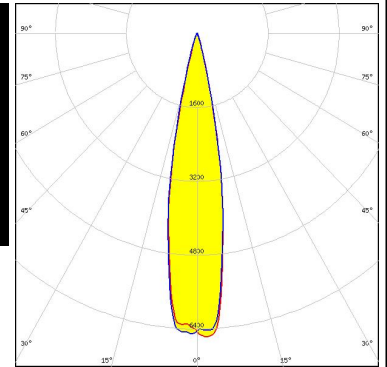
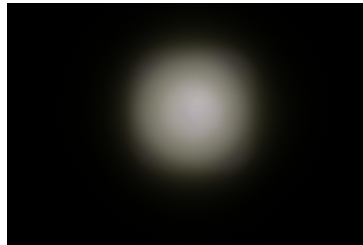

#### CREE LED

LED XQ-E HI  
 FWHM / FWTM 4.0° / 8.0°  
 Efficiency 91 %  
 Peak intensity 129.5 cd/lm  
 LEDs/each optic 1  
 Light colour White  
 Required components:

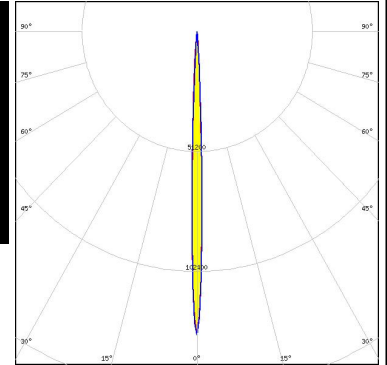

#### CREE LED

LED XT-E  
 FWHM / FWTM 7.0° / 12.0°  
 Efficiency 86 %  
 Peak intensity 47.5 cd/lm  
 LEDs/each optic 1  
 Light colour White  
 Required components:

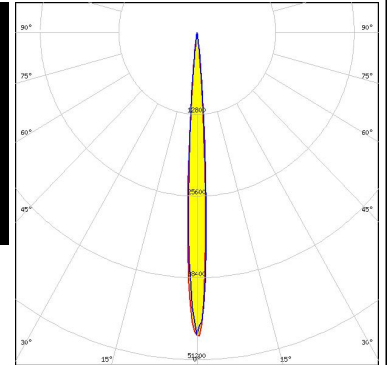
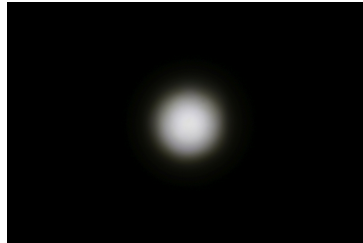

#### LUMILEDS

LED LUXEON C  
 FWHM / FWTM 5.0° / 9.0°  
 Efficiency 86 %  
 Peak intensity 91.5 cd/lm  
 LEDs/each optic 1  
 Light colour White  
 Required components:

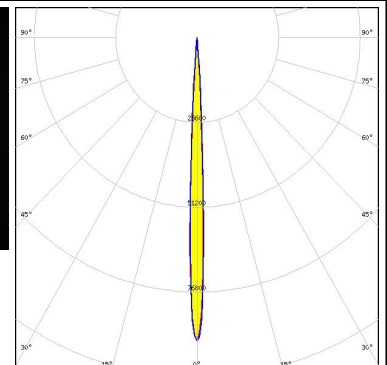
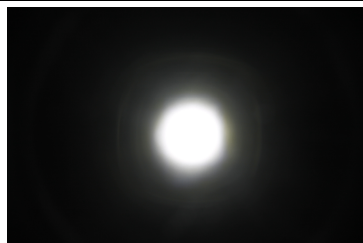

### OPTICAL RESULTS (MEASURED):

#### LUMILEDS

LED LUXEON CZ  
 FWHM / FWTM 4.0° / 9.0°  
 Efficiency 93 %  
 Peak intensity 124 cd/lm  
 LEDs/each optic 1  
 Light colour White  
 Required components:

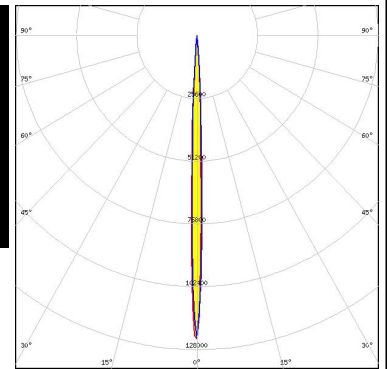

#### LUMILEDS

LED LUXEON Z  
 FWHM / FWTM 4.0° / 7.0°  
 Efficiency 92 %  
 Peak intensity 158 cd/lm  
 LEDs/each optic 1  
 Light colour White  
 Required components:

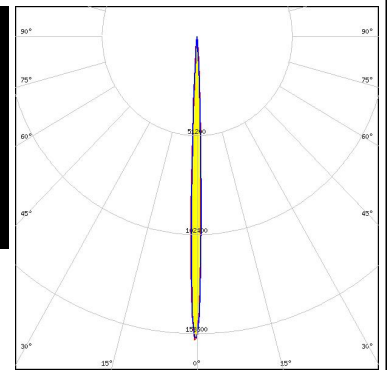

#### NICHIA

LED NVSW219F  
 FWHM / FWTM 7.0° / 13.0°  
 Efficiency 92 %  
 Peak intensity 46 cd/lm  
 LEDs/each optic 1  
 Light colour White  
 Required components:

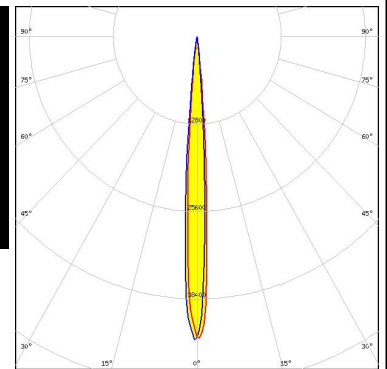
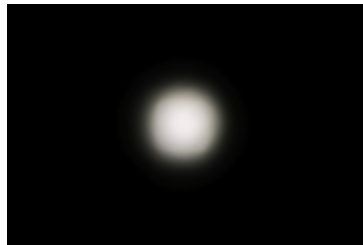

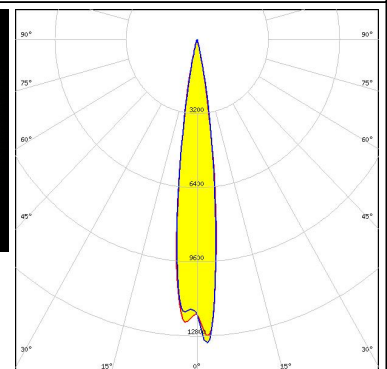
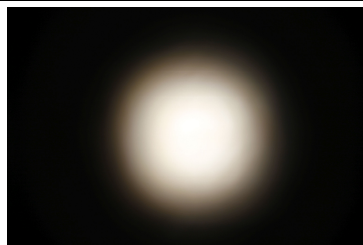

#### OSRAM

Opto Semiconductors  
 LED Duris S8  
 FWHM / FWTM 14.0° / 24.0°  
 Efficiency 90 %  
 Peak intensity 13.5 cd/lm  
 LEDs/each optic 1  
 Light colour White  
 Required components:

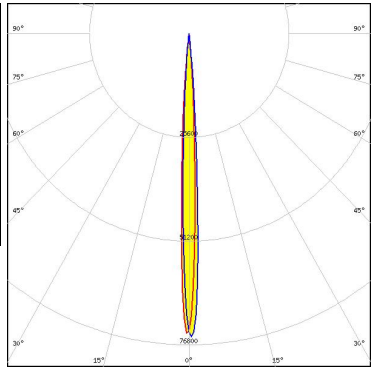
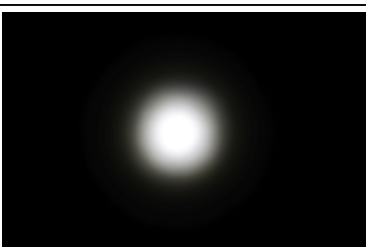
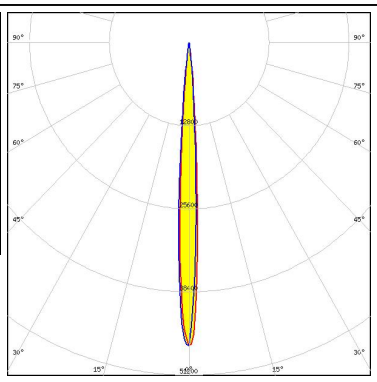
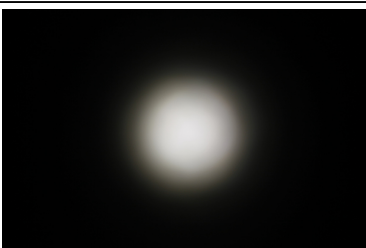
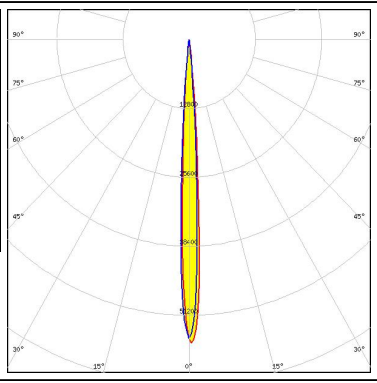

### OPTICAL RESULTS (MEASURED):

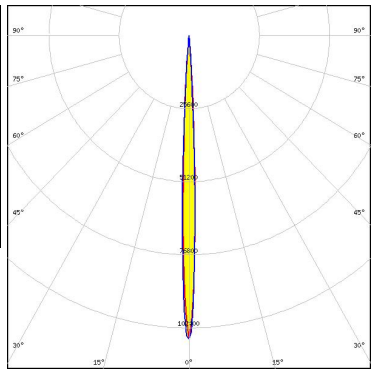
<p><b>OSRAM</b> Opto Semiconductors</p> <p>LED                    KW CULPM1.TG</p> <p>FWHM / FWTM      6.0° / 11.0°</p> <p>Efficiency            92 %</p> <p>Peak intensity      75.2 cd/lm</p> <p>LEDs/each optic    1</p> <p>Light colour        White</p> <p>Required components:</p>		
<p><b>OSRAM</b> Opto Semiconductors</p> <p>LED                    OSCONIQ P 3737 (2W version)</p> <p>FWHM / FWTM      7.0° / 13.0°</p> <p>Efficiency            90 %</p> <p>Peak intensity      47.7 cd/lm</p> <p>LEDs/each optic    1</p> <p>Light colour        White</p> <p>Required components:</p>		
<p><b>OSRAM</b> Opto Semiconductors</p> <p>LED                    OSLON Square EC</p> <p>FWHM / FWTM      6.0° / 12.0°</p> <p>Efficiency            90 %</p> <p>Peak intensity      56 cd/lm</p> <p>LEDs/each optic    1</p> <p>Light colour        White</p> <p>Required components:</p>		
<p><b>OSRAM</b> Opto Semiconductors</p> <p>LED                    OSLON SSL 150</p> <p>FWHM / FWTM      5.0° / 9.0°</p> <p>Efficiency            93 %</p> <p>Peak intensity      106 cd/lm</p> <p>LEDs/each optic    1</p> <p>Light colour        White</p> <p>Required components:</p>		

### OPTICAL RESULTS (MEASURED):

#### SAMSUNG

LED LH181B  
 FWHM / FWTM 7.0° / 13.0°  
 Efficiency 91 %  
 Peak intensity 48.2 cd/lm  
 LEDs/each optic 1  
 Light colour White  
 Required components:

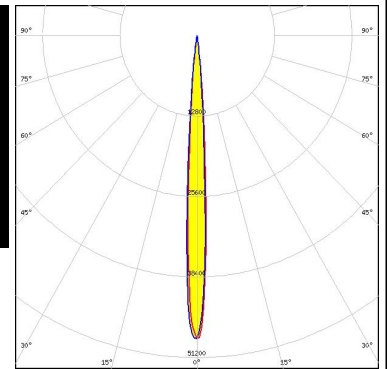
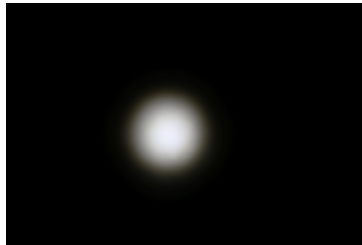

#### SAMSUNG

LED LH508A  
 FWHM / FWTM 13.0° / 21.0°  
 Efficiency 91 %  
 Peak intensity 16.9 cd/lm  
 LEDs/each optic 1  
 Light colour White  
 Required components:

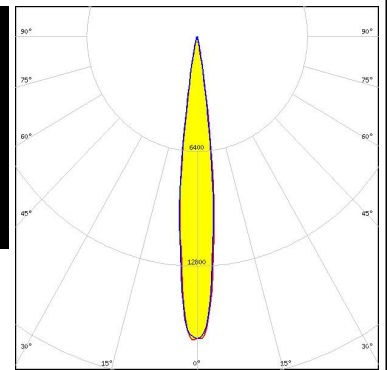
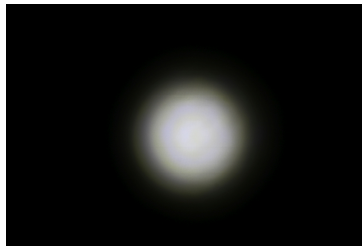

SEOUL SEMICONDUCTOR

LED WICOP 5050  
 FWHM / FWTM 15.0° / 24.0°  
 Efficiency 86 %  
 Peak intensity 11.5 cd/lm  
 LEDs/each optic 1  
 Light colour White  
 Required components:

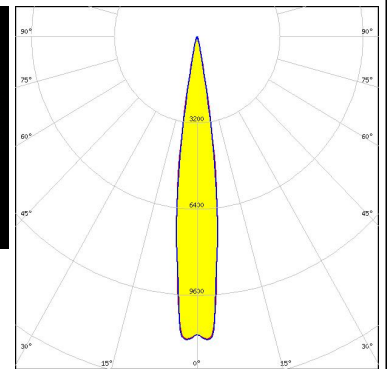





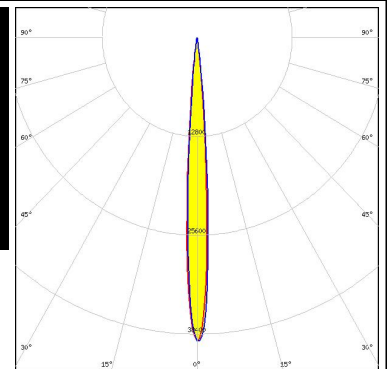
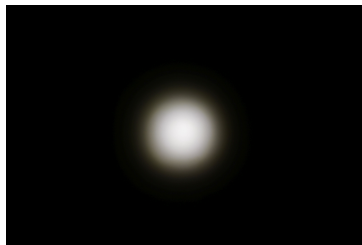

SEOUL SEMICONDUCTOR

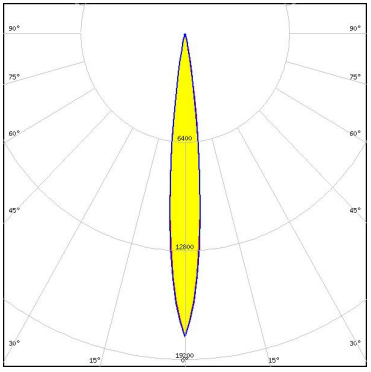

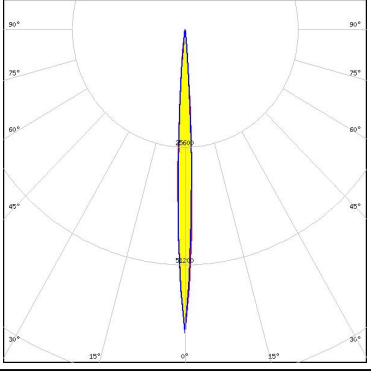

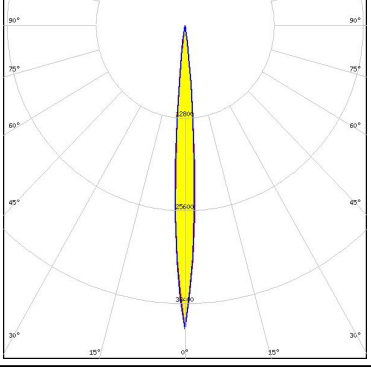

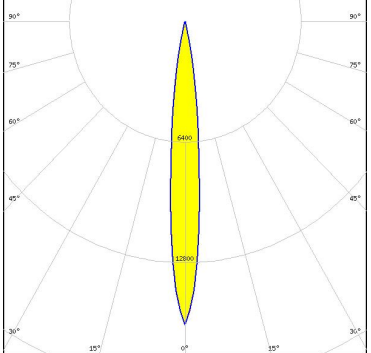
LED Z5M3  
 FWHM / FWTM 8.0° / 14.0°  
 Efficiency 90 %  
 Peak intensity 39.3 cd/lm  
 LEDs/each optic 1  
 Light colour White  
 Required components:

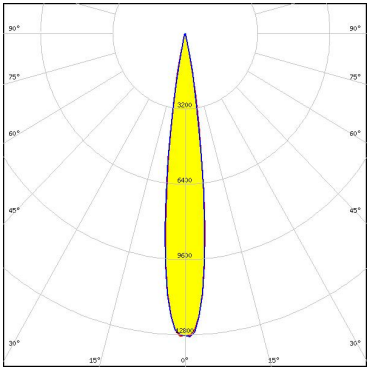

### OPTICAL RESULTS (SIMULATED):

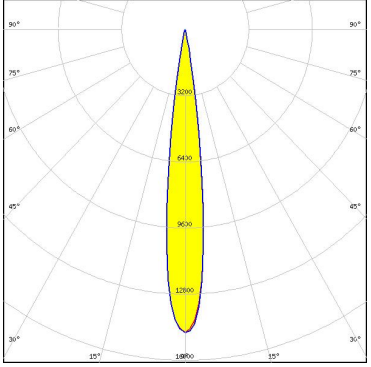
<p> LED Bridgelux SMD 5050</p> <p>FWHM / FWTM 12.0° / 22.0°</p> <p>Efficiency 93 %</p> <p>Peak intensity 17.9 cd/lm</p> <p>LEDs/each optic 1</p> <p>Light colour White</p> <p>Required components:</p>	
<p> LED XD16</p> <p>FWHM / FWTM 6.0° / 11.0°</p> <p>Efficiency 87 %</p> <p>Peak intensity 66 cd/lm</p> <p>LEDs/each optic 1</p> <p>Light colour White</p> <p>Required components:</p>	
<p> LED XHP35 HI</p> <p>FWHM / FWTM 8.0° / 14.0°</p> <p>Efficiency 91 %</p> <p>Peak intensity 41.9 cd/lm</p> <p>LEDs/each optic 1</p> <p>Light colour White</p> <p>Required components:</p>	
<p> LED XHP35.2 HD</p> <p>FWHM / FWTM 12.0° / 22.0°</p> <p>Efficiency 89 %</p> <p>Peak intensity 16.1 cd/lm</p> <p>LEDs/each optic 1</p> <p>Light colour White</p> <p>Required components:</p>	

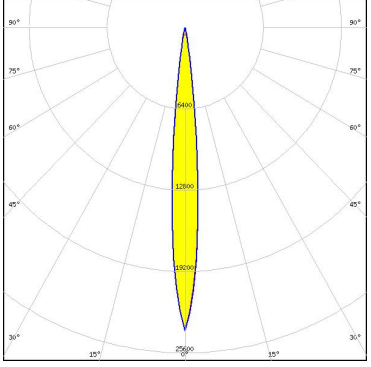
### OPTICAL RESULTS (SIMULATED):

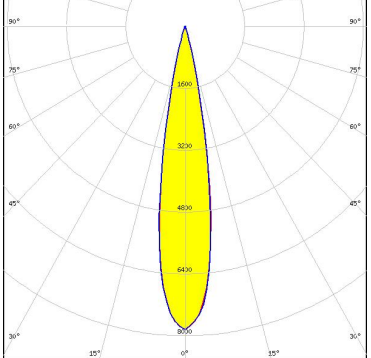
	<p>LED XHP50.2            FWHM / FWTM 14.0° / 24.0°            Efficiency 89 %            Peak intensity 13 cd/lm            LEDs/each optic 1            Light colour White            Required components:</p>	
	<p>LED XHP50.3 HD            FWHM / FWTM 14.0° / 22.0°            Efficiency 89 %            Peak intensity 14.7 cd/lm            LEDs/each optic 1            Light colour White            Required components:</p>	
	<p>LED XHP50.3 HI            FWHM / FWTM 10.0° / 18.0°            Efficiency 91 %            Peak intensity 23.9 cd/lm            LEDs/each optic 1            Light colour White            Required components:</p>	
	<p>LED XHP70.3 HD            FWHM / FWTM 18.0° / 30.0°            Efficiency 88 %            Peak intensity 7.9 cd/lm            LEDs/each optic 1            Light colour White            Required components:</p>	

### OPTICAL RESULTS (SIMULATED):

#### CREE LED

LED XP-E2  
 FWHM / FWTM 5.0° / 10.0°  
 Efficiency 91 %  
 Peak intensity 85 cd/lm  
 LEDs/each optic 1  
 Light colour White  
 Required components:

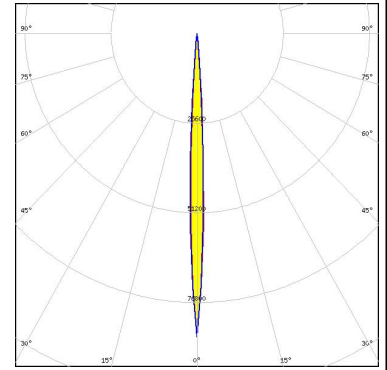

#### CREE LED

LED XP-G2  
 FWHM / FWTM 6.0° / 12.0°  
 Efficiency 91 %  
 Peak intensity 58 cd/lm  
 LEDs/each optic 1  
 Light colour White  
 Required components:

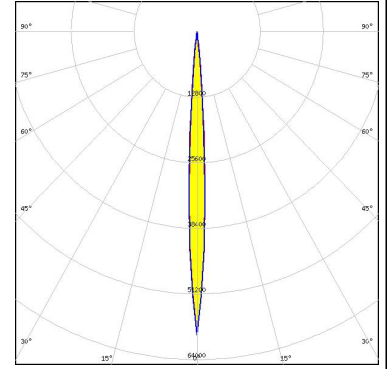

#### CREE LED

LED XP-G2 HE  
 FWHM / FWTM 8.0° / 16.0°  
 Efficiency 91 %  
 Peak intensity 38 cd/lm  
 LEDs/each optic 1  
 Light colour White  
 Required components:

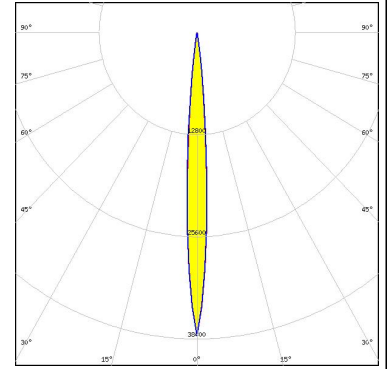

#### CREE LED

LED XP-G3  
 FWHM / FWTM 7.7° / 14.0°  
 Efficiency 90 %  
 Peak intensity 40.8 cd/lm  
 LEDs/each optic 1  
 Light colour White  
 Required components:

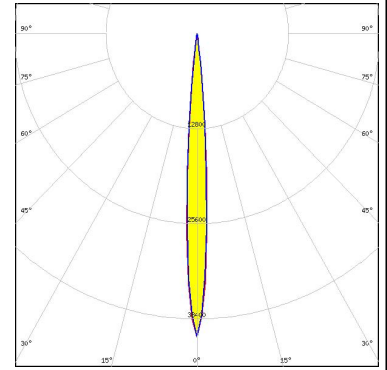



### OPTICAL RESULTS (SIMULATED):

#### CREE LED

LED XP-L HI  
 FWHM / FWTM 6.0° / 12.0°  
 Efficiency 91 %  
 Peak intensity 53 cd/m  
 LEDs/each optic 1  
 Light colour White  
 Required components:

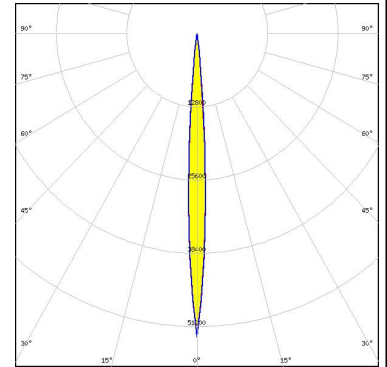

#### CREE LED

LED XP-P  
 FWHM / FWTM 4.0° / 10.0°  
 Efficiency 94 %  
 Peak intensity 100 cd/m  
 LEDs/each optic 1  
 Light colour White  
 Required components:

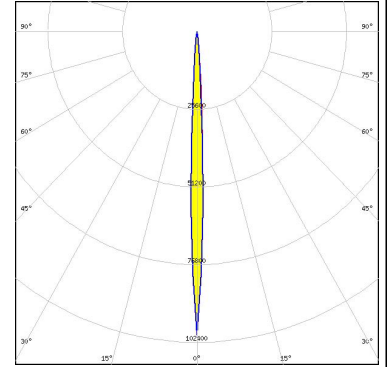

#### CREE LED

LED XQ-E HD  
 FWHM / FWTM 5.2° / 9.5°  
 Efficiency 92 %  
 Peak intensity 96.2 cd/m  
 LEDs/each optic 1  
 Light colour White  
 Required components:

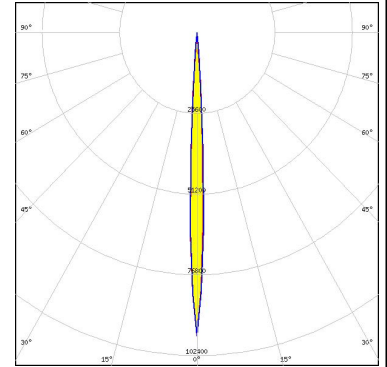

#### LUMILEDS

LED LUXEON 3030 2D (Round LES)  
 FWHM / FWTM 6.0° / 14.0°  
 Efficiency 90 %  
 Peak intensity 51.4 cd/m  
 LEDs/each optic 1  
 Light colour White  
 Required components:

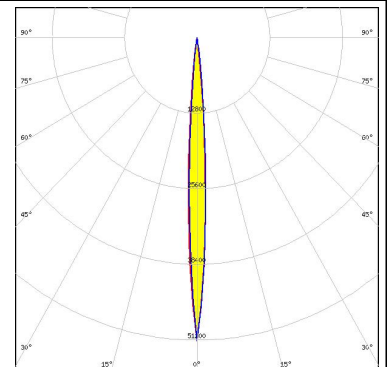

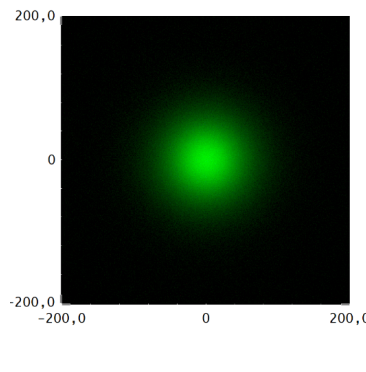
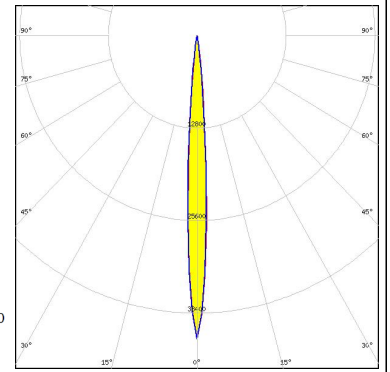
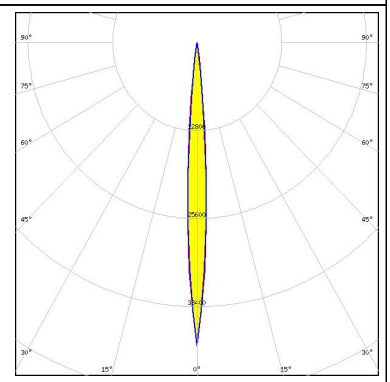
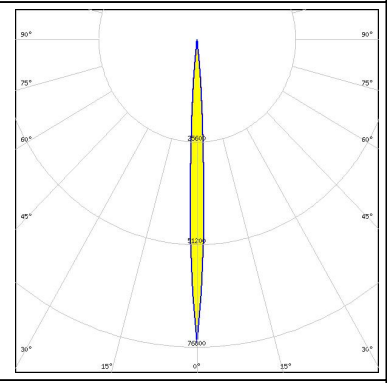
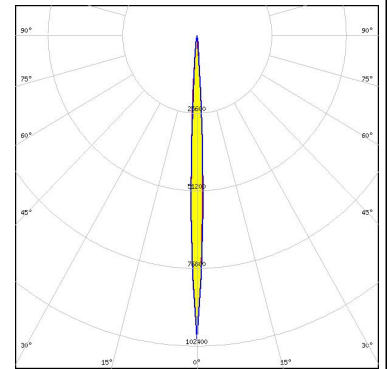

### OPTICAL RESULTS (SIMULATED):

<p><b>LUMILEDS</b></p> <p>LED: LUXEON CZ</p> <p>FWHM / FWTM: 8.0° / 14.0°</p> <p>Efficiency: 92 %</p> <p>Peak intensity: 42 cd/lm</p> <p>LEDs/each optic: 1</p> <p>Light colour: Green</p> <p>Required components:</p>		
<p><b>LUMILEDS</b></p> <p>LED: LUXEON HL2X</p> <p>FWHM / FWTM: 8.0° / 14.0°</p> <p>Efficiency: 91 %</p> <p>Peak intensity: 44.1 cd/lm</p> <p>LEDs/each optic: 1</p> <p>Light colour: White</p> <p>Required components:</p>		
<p><b>LUMILEDS</b></p> <p>LED: LUXEON Rebel Plus</p> <p>FWHM / FWTM: 6.0° / 10.0°</p> <p>Efficiency: 91 %</p> <p>Peak intensity: 75.7 cd/lm</p> <p>LEDs/each optic: 1</p> <p>Light colour: White</p> <p>Required components:</p>		
<p><b>LUMILEDS</b></p> <p>LED: LUXEON Rubix</p> <p>FWHM / FWTM: 4.0° / 10.0°</p> <p>Efficiency: 91 %</p> <p>Peak intensity: 100.1 cd/lm</p> <p>LEDs/each optic: 1</p> <p>Light colour: Green</p> <p>Required components:</p>		

### OPTICAL RESULTS (SIMULATED):

#### LUMILEDS

LED LUXEON Rubix  
 FWHM / FWTM 4.0° / 10.0°  
 Efficiency 91 %  
 Peak intensity 104.2 cd/lm  
 LEDs/each optic 1  
 Light colour Red  
 Required components:

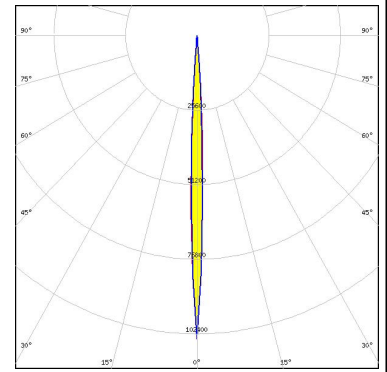

#### LUMILEDS

LED LUXEON Rubix  
 FWHM / FWTM 4.0° / 10.0°  
 Efficiency 91 %  
 Peak intensity 97.1 cd/lm  
 LEDs/each optic 1  
 Light colour White  
 Required components:

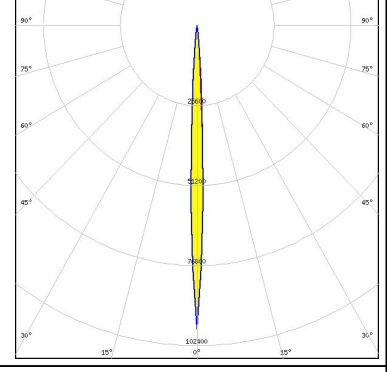

#### LUMILEDS

LED LUXEON Rubix  
 FWHM / FWTM 4.0° / 10.0°  
 Efficiency 91 %  
 Peak intensity 99.6 cd/lm  
 LEDs/each optic 1  
 Light colour Blue  
 Required components:

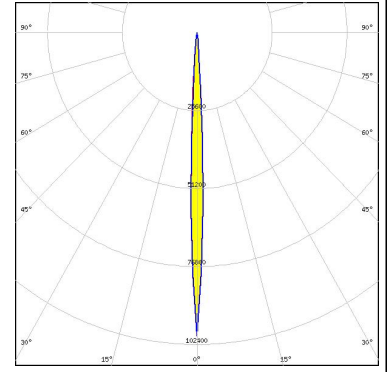

#### NICHIA

LED NCSxE17A  
 FWHM / FWTM 6.0° / 10.0°  
 Efficiency 87 %  
 Peak intensity 69.3 cd/lm  
 LEDs/each optic 1  
 Light colour White  
 Required components:

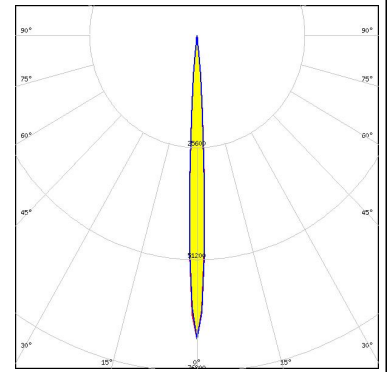

## OPTICAL RESULTS (SIMULATED):

<p><b>NICHIA</b></p> <p>LED NVSxE21A            FWHM / FWTM 6.0° / 14.0°            Efficiency 88 %            Peak intensity 48.2 cd/lm            LEDs/each optic 1            Light colour White            Required components:</p>	
<p><b>OSRAM</b> Opto Semiconductors</p> <p>LED OSLOM Square CSSRM2/CSSRM3            FWHM / FWTM 6.4° / 13.0°            Efficiency 92 %            Peak intensity 60.7 cd/lm            LEDs/each optic 1            Light colour White            Required components:</p>	
<p><b>OSRAM</b> Opto Semiconductors</p> <p>LED OSTAR Projection Compact (Kx.CSLNM1.xx)            FWHM / FWTM 4.0° / 10.0°            Efficiency 91 %            Peak intensity 103.8 cd/lm            LEDs/each optic 1            Light colour White            Required components:</p>	
<p><b>OSRAM</b> Opto Semiconductors</p> <p>LED OSTAR Projection Compact (Kx.CSLNM1.xx)            FWHM / FWTM 4.0° / 8.0°            Efficiency 90 %            Peak intensity 133.4 cd/lm            LEDs/each optic 1            Light colour White            Required components:</p>	

### OPTICAL RESULTS (SIMULATED):

#### SAMSUNG

LED	LM101B
FWHM / FWTM	6.0° / 12.0°
Efficiency	90 %
Peak intensity	69.6 cd/lm
LEDs/each optic	1
Light colour	White
Required components:	

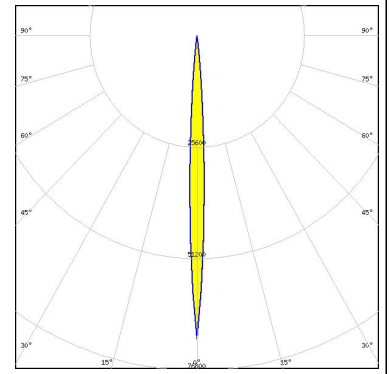

### GENERAL INFORMATION:

NOTE: The typical beam angle will be changed by different color, chip size and chip position tolerance. The typical total beam angle is the full angle measured where the luminous intensity is half of the peak value.

### MATERIALS:

As part of our continuous research and improvement processes, and to ensure the best possible quality and availability of our products, LEDiL reserves the right to change material grades without notice.

### PRODUCT DATA USER AGREEMENT AND DISCLAIMER:

The measured data in the provided downloadable LEDiL Product Datasheets and Mechanical 2D-Drawings is rounded and provided as reference for planning. LEDiL Oy's optical specifications have been verified by conducting performance testing of the products in accordance with the company's quality system. The reported data are averaged results of multiple measurements with typical variation. LEDiL Oy reserves the right to without prior notification make changes and improvements to its products.

LEDiL Oy assumes neither warranty, nor guarantee nor any other liability of any kind for the contents and correctness of the provided data. The provided data has been generated with highest diligence but the provided data may in reality not represent the complete possible variation range of all intrinsic parameters. Therefore, in certain cases a deviation from the provided data could occur.

LEDiL Oy reserves the right to undertake technical changes of its products without further notification which could lead to changes in the provided data. LEDiL Oy assumes no liability of any kind for the possible deviation from any provided data or any other damage resulting from the usage of the provided data.

The user agrees to this disclaimer and user agreement with the download or usage of the provided files.

#### LEDiL Oy

Joensuunkatu 13  
FI-24240 SALO  
Finland

#### LEDiL Inc.

228 West Page Street  
Suite D  
Sycamore IL 60178  
USA

#### Ledil Optics Technology (Shenzhen) Co., Ltd.

# 405 , Block B  
Casic Motor Building  
Shenzhen 518057  
P.R.CHINA

#### Local sales and technical support

[www.ledil.com/  
where\\_to\\_buy](http://www.ledil.com/where_to_buy)

#### Shipping locations

Salo, Finland  
Hong Kong, China

#### Distribution Partners

[www.ledil.com/  
where\\_to\\_buy](http://www.ledil.com/where_to_buy)