

### Applications

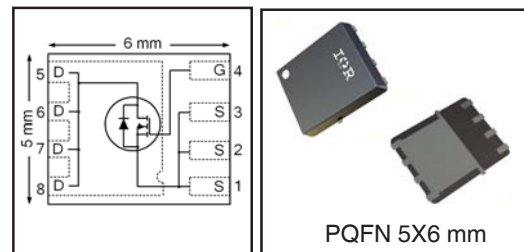
- High Frequency Point-of-Load Synchronous Buck Converter for Applications in Networking & Computing Systems
- Optimized for Control FET Applications

HEXFET® Power MOSFET

$V_{DS}$	$R_{DS(on)}$ max	Qg
30V	8.5mΩ @ $V_{GS} = 10V$	9.3nC

### Benefits

- Very low  $R_{DS(ON)}$  at 4.5V  $V_{GS}$
- Low Gate Charge
- Fully Characterized Avalanche Voltage and Current
- 100% Tested for  $R_G$
- Lead-Free (Qualified up to 260°C Reflow)
- RoHS compliant (Halogen Free)
- Low Thermal Resistance
- Large Source Lead for more reliable Soldering



### Absolute Maximum Ratings

	Parameter	Max.	Units
$V_{DS}$	Drain-to-Source Voltage	30	V
$V_{GS}$	Gate-to-Source Voltage	± 20	
$I_D @ T_A = 25^\circ C$	Continuous Drain Current, $V_{GS} @ 10V$	15	A
$I_D @ T_A = 70^\circ C$	Continuous Drain Current, $V_{GS} @ 10V$	12	
$I_D @ T_C = 25^\circ C$	Continuous Drain Current, $V_{GS} @ 10V$	34	
$I_{DM}$	Pulsed Drain Current ①	120	
$P_D @ T_A = 25^\circ C$	Power Dissipation ②	3.1	W
$P_D @ T_A = 70^\circ C$	Power Dissipation ②	2.0	
	Linear Derating Factor ③	0.025	W/°C
$T_J$	Operating Junction and	-55 to + 150	°C
$T_{STG}$	Storage Temperature Range		

### Thermal Resistance

	Parameter	Typ.	Max.	Units
$R_{\theta JC}$	Junction-to-Case ④	—	7.9	°C/W
$R_{\theta JA}$	Junction-to-Ambient ⑤	—	40	

Notes ① through ⑤ are on page 9

**Static @ T<sub>J</sub> = 25°C (unless otherwise specified)**

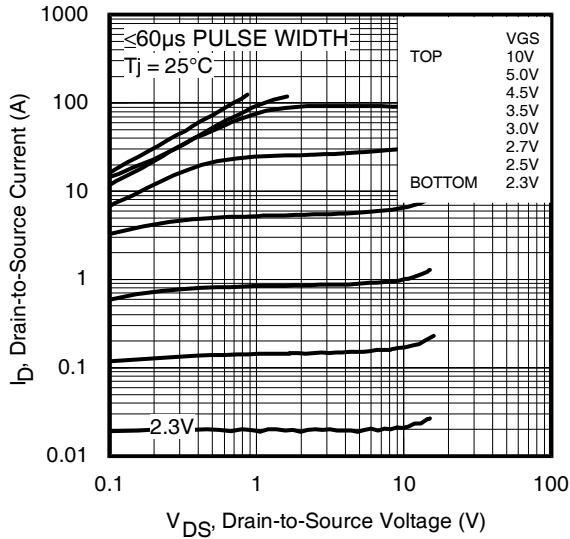
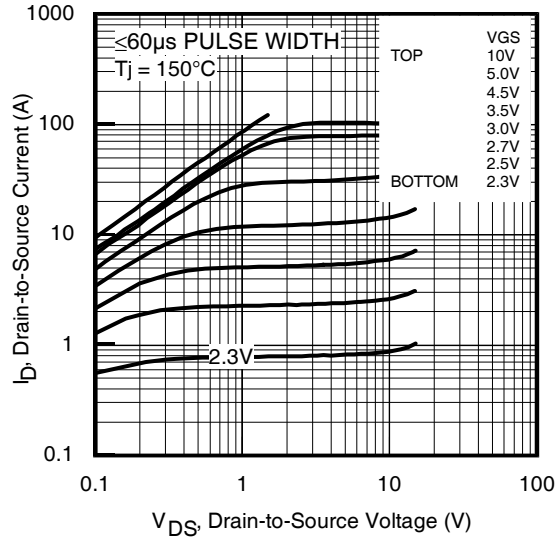
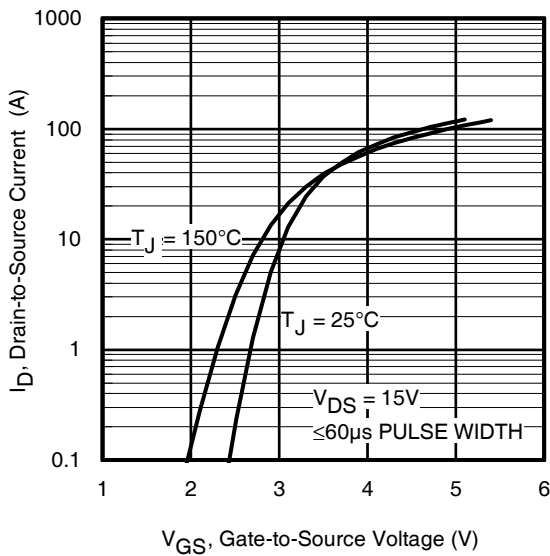
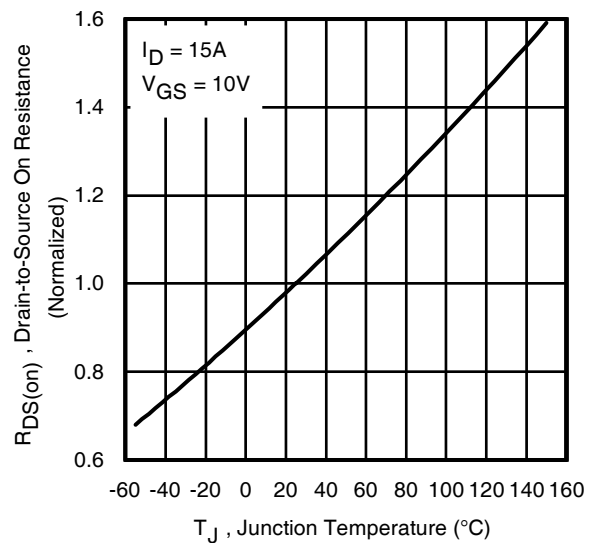
	Parameter	Min.	Typ.	Max.	Units	Conditions
BV <sub>DSS</sub>	Drain-to-Source Breakdown Voltage	30	—	—	V	V <sub>GS</sub> = 0V, I <sub>D</sub> = 250μA
ΔBV <sub>DSS</sub> /ΔT <sub>J</sub>	Breakdown Voltage Temp. Coefficient	—	0.02	—	V/°C	Reference to 25°C, I <sub>D</sub> = 1mA
R <sub>DS(on)</sub>	Static Drain-to-Source On-Resistance	—	7.1	8.5	mΩ	V <sub>GS</sub> = 10V, I <sub>D</sub> = 15A ③
		—	10.4	12.5		V <sub>GS</sub> = 4.5V, I <sub>D</sub> = 12A ③
V <sub>GS(th)</sub>	Gate Threshold Voltage	1.35	1.8	2.35	V	V <sub>DS</sub> = V <sub>GS</sub> , I <sub>D</sub> = 25μA
ΔV <sub>GS(th)</sub>	Gate Threshold Voltage Coefficient	—	-6.2	—	mV/°C	
I <sub>DSS</sub>	Drain-to-Source Leakage Current	—	—	1.0	μA	V <sub>DS</sub> = 24V, V <sub>GS</sub> = 0V
		—	—	150		V <sub>DS</sub> = 24V, V <sub>GS</sub> = 0V, T <sub>J</sub> = 125°C
I <sub>GSS</sub>	Gate-to-Source Forward Leakage	—	—	100	nA	V <sub>GS</sub> = 20V
	Gate-to-Source Reverse Leakage	—	—	-100		V <sub>GS</sub> = -20V
g <sub>fs</sub>	Forward Transconductance	27	—	—	S	V <sub>DS</sub> = 15V, I <sub>D</sub> = 12A
Q <sub>g</sub>	Total Gate Charge	—	9.3	14	nC	V <sub>DS</sub> = 15V V <sub>GS</sub> = 4.5V I <sub>D</sub> = 12A See Fig.17 & 18
Q <sub>gs1</sub>	Pre-V <sub>th</sub> Gate-to-Source Charge	—	2.2	—		
Q <sub>gs2</sub>	Post-V <sub>th</sub> Gate-to-Source Charge	—	1.2	—		
Q <sub>gd</sub>	Gate-to-Drain Charge	—	3.2	—		
Q <sub>godr</sub>	Gate Charge Overdrive	—	2.7	—		
Q <sub>sw</sub>	Switch Charge (Q <sub>gs2</sub> + Q <sub>gd</sub> )	—	4.4	—		
Q <sub>oss</sub>	Output Charge	—	5.0	—	nC	V <sub>DS</sub> = 16V, V <sub>GS</sub> = 0V
R <sub>G</sub>	Gate Resistance	—	1.4	2.4	Ω	
t <sub>d(on)</sub>	Turn-On Delay Time	—	12	—	ns	V <sub>DD</sub> = 15V, V <sub>GS</sub> = 4.5V I <sub>D</sub> = 12A R <sub>G</sub> = 1.8Ω See Fig.15
t <sub>r</sub>	Rise Time	—	7.6	—		
t <sub>d(off)</sub>	Turn-Off Delay Time	—	14	—		
t <sub>f</sub>	Fall Time	—	4.7	—		
C <sub>iss</sub>	Input Capacitance	—	1210	—	pF	V <sub>GS</sub> = 0V V <sub>DS</sub> = 15V f = 1.0MHz
C <sub>oss</sub>	Output Capacitance	—	240	—		
C <sub>rss</sub>	Reverse Transfer Capacitance	—	120	—		

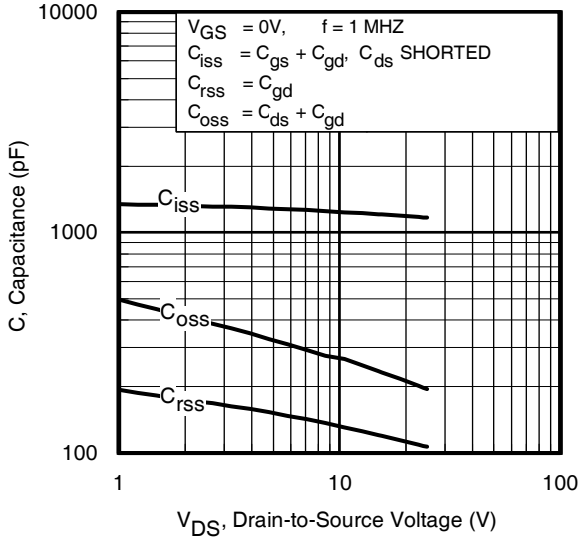
**Avalanche Characteristics**

	Parameter	Typ.	Max.	Units
E <sub>AS</sub>	Single Pulse Avalanche Energy ②	—	29	mJ
I <sub>AR</sub>	Avalanche Current ①	—	12	A

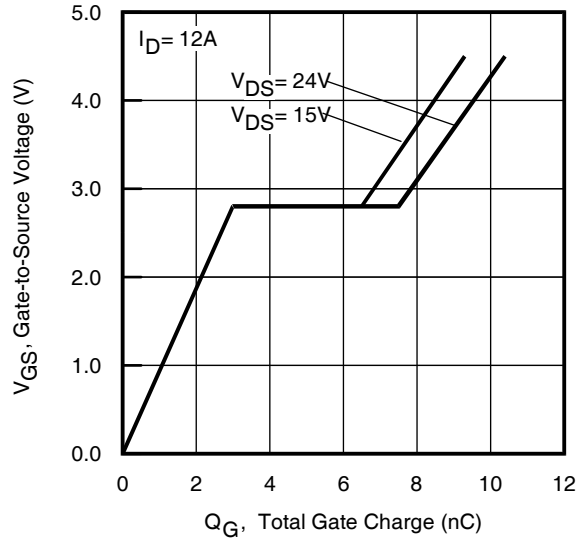
**Diode Characteristics**

	Parameter	Min.	Typ.	Max.	Units	Conditions
I <sub>S</sub>	Continuous Source Current (Body Diode)	—	—	3.9	A	MOSFET symbol showing the integral reverse p-n junction diode.
I <sub>SM</sub>	Pulsed Source Current (Body Diode) ①	—	—	120		
V <sub>SD</sub>	Diode Forward Voltage	—	—	1.0	V	T <sub>J</sub> = 25°C, I <sub>S</sub> = 12A, V <sub>GS</sub> = 0V ③
t <sub>rr</sub>	Reverse Recovery Time	—	12	18	ns	T <sub>J</sub> = 25°C, I <sub>F</sub> = 12A, V <sub>DD</sub> = 15V
Q <sub>rr</sub>	Reverse Recovery Charge	—	11	17	nC	di/dt = 300A/μs ③
t <sub>on</sub>	Forward Turn-On Time	Intrinsic turn-on time is negligible (turn-on is dominated by LS+LD)				

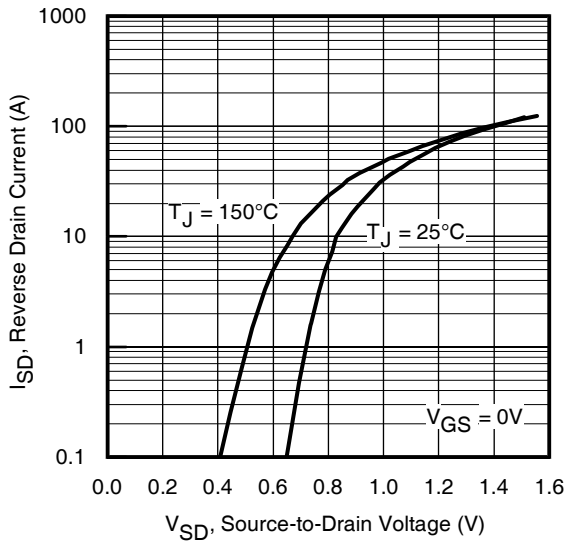

**Fig 1.** Typical Output Characteristics

**Fig 2.** Typical Output Characteristics

**Fig 3.** Typical Transfer Characteristics

**Fig 4.** Normalized On-Resistance vs. Temperature



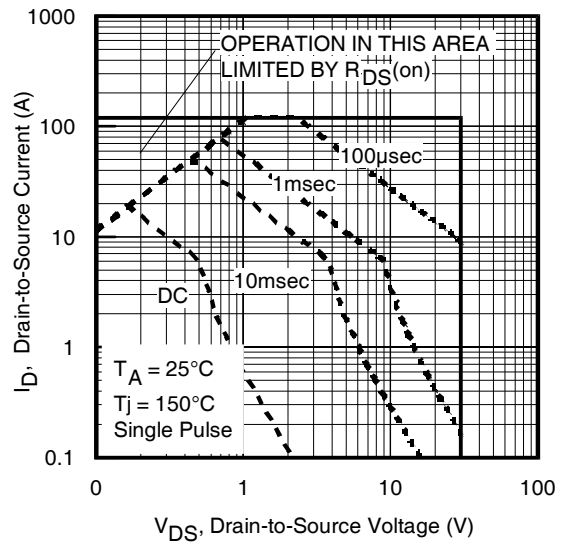
**Fig 5.** Typical Capacitance vs. Drain-to-Source Voltage



**Fig 6.** Typical Gate Charge vs. Gate-to-Source Voltage



**Fig 7.** Typical Source-Drain Diode Forward Voltage



**Fig 8.** Maximum Safe Operating Area

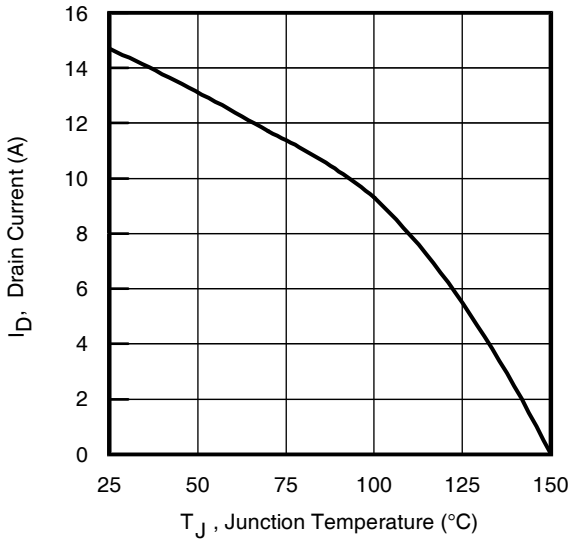


Fig 9. Maximum Drain Current vs. Ambient Temperature

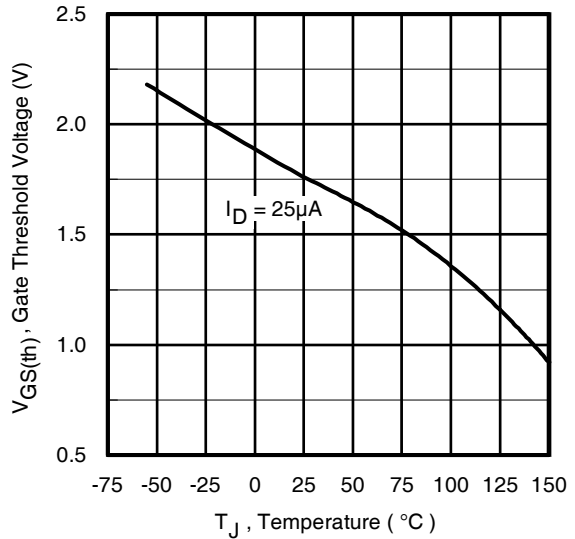


Fig 10. Threshold Voltage vs. Temperature

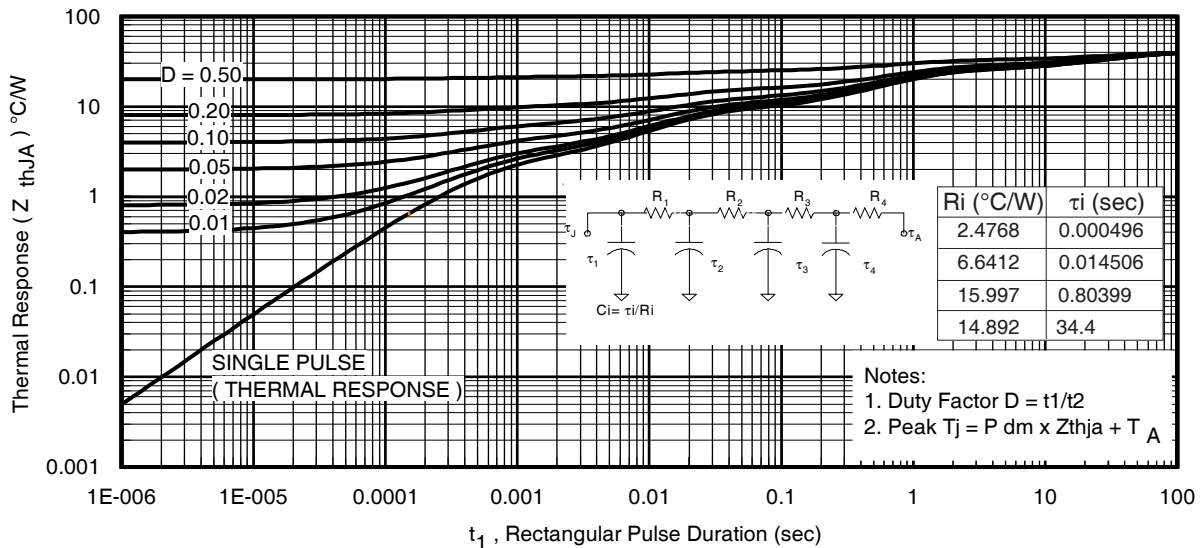
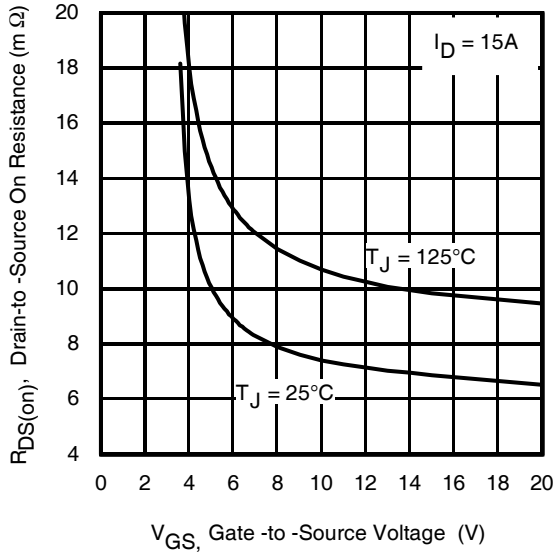
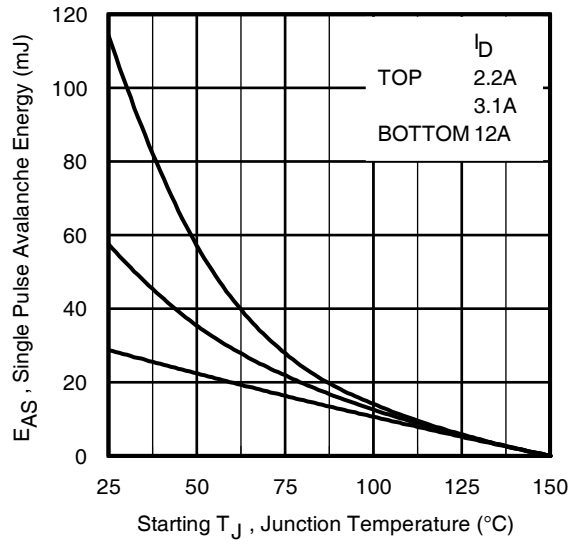
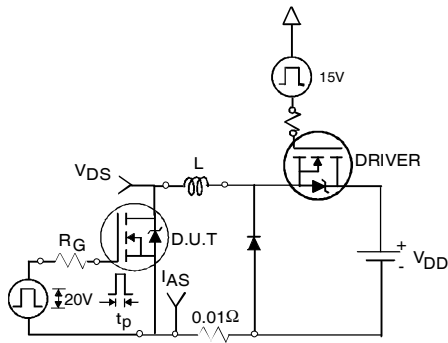
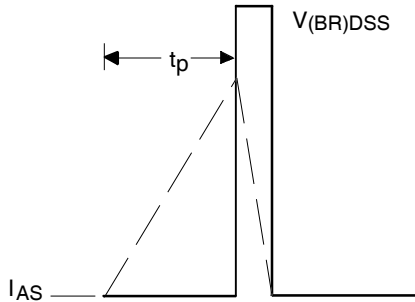
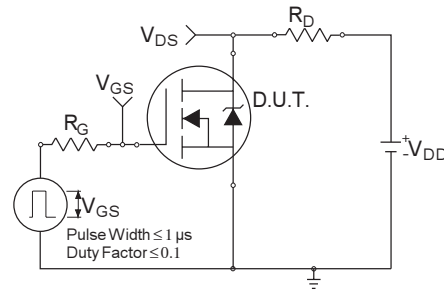
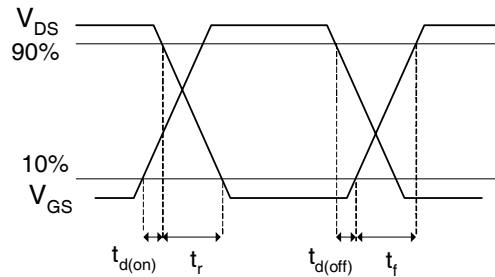
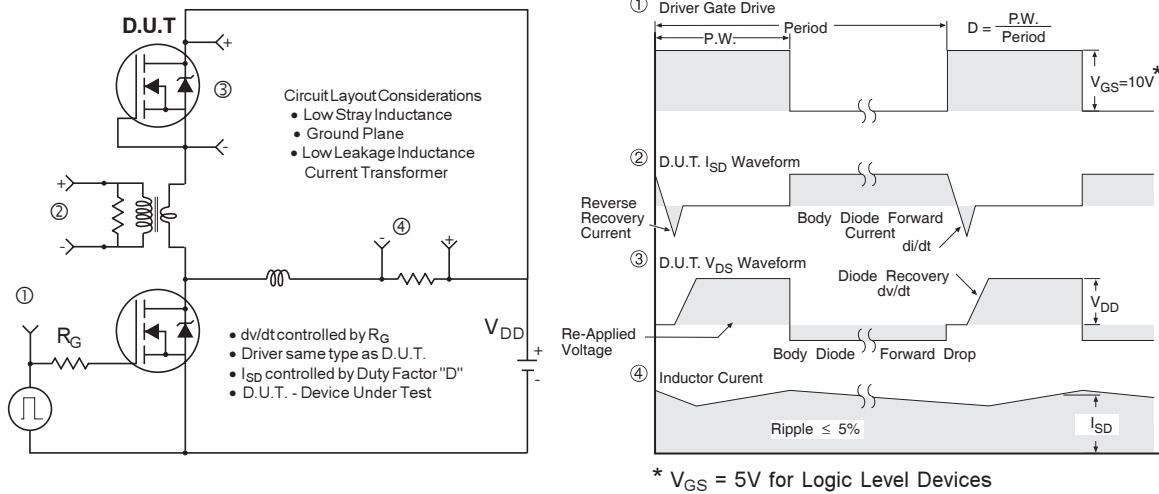
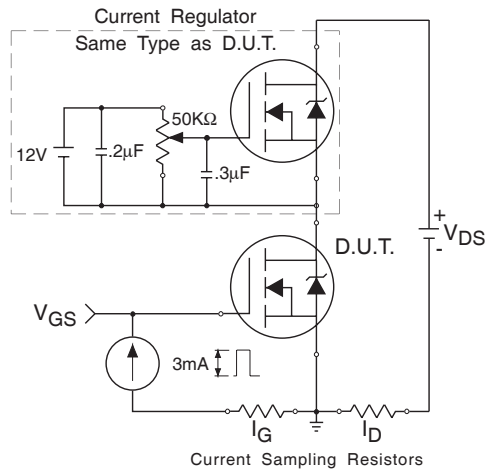


Fig 11. Maximum Effective Transient Thermal Impedance, Junction-to-Ambient

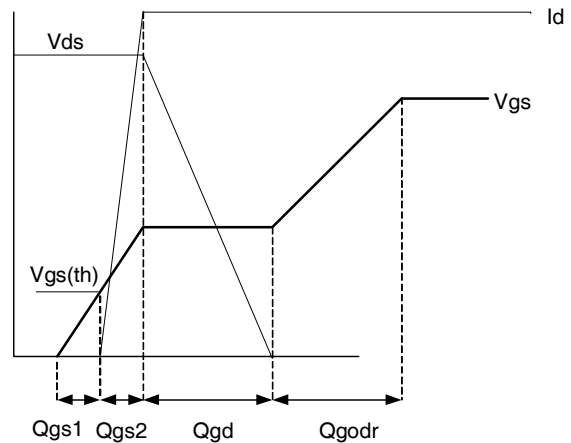

**Fig 12. On-Resistance vs. Gate Voltage**

**Fig 13. Maximum Avalanche Energy vs. Drain Current**

**Fig 14a. Unclamped Inductive Test Circuit**

**Fig 14b. Unclamped Inductive Waveforms**

**Fig 15a. Switching Time Test Circuit**

**Fig 15b. Switching Time Waveforms**



**Fig 16. Peak Diode Recovery  $dv/dt$  Test Circuit for N-Channel HEXFET® Power MOSFETs**

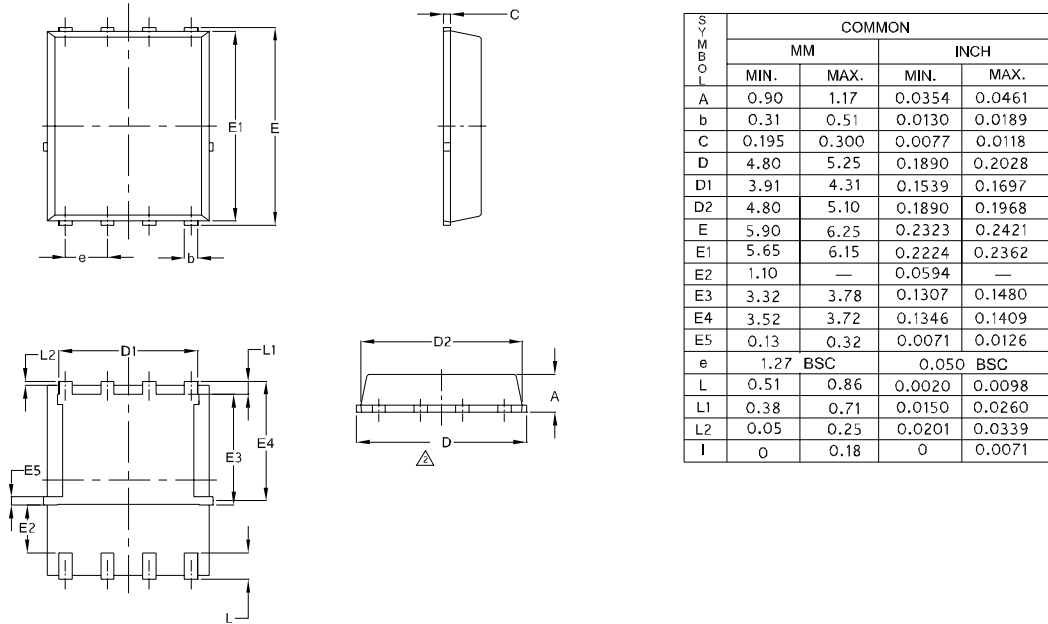


**Fig 17. Gate Charge Test Circuit**

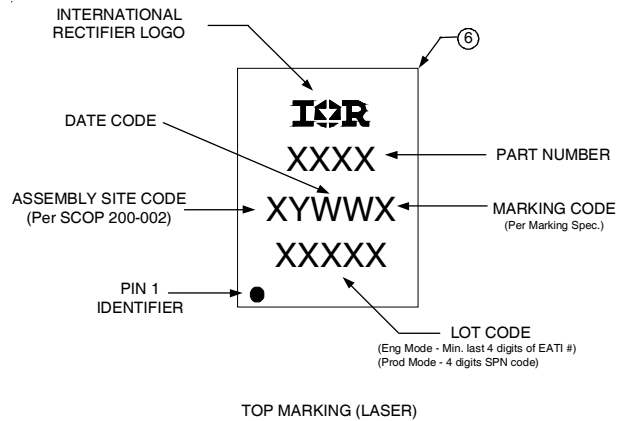


**Fig 18. Gate Charge Waveform**

## PQFN 5x6 Option "E" Package Details



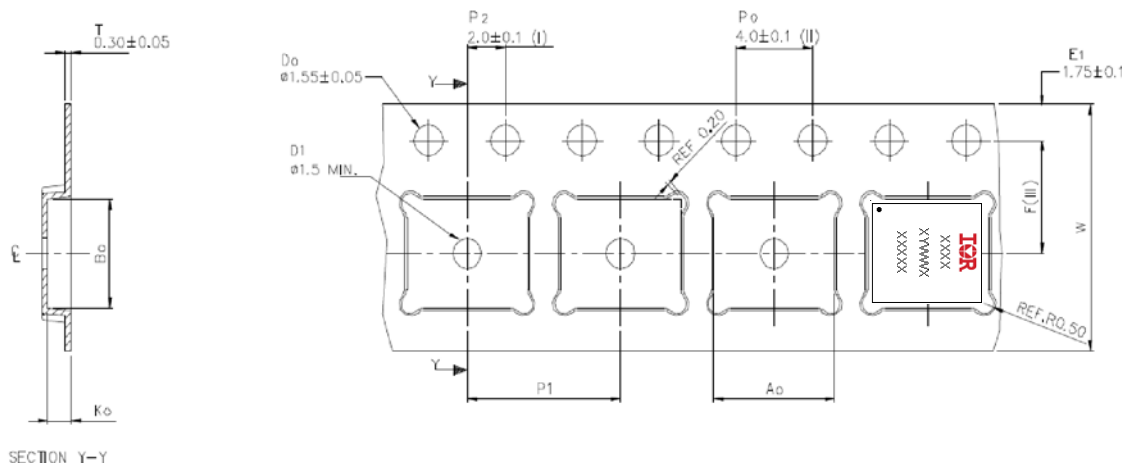
## PQFN Part Marking



Note: For the most current drawing please refer to IR website at <http://www.irf.com/package/>



## PQFN Tape and Reel



A <sub>0</sub>	6.30 +/− 0.1
B <sub>0</sub>	5.30 +/− 0.1
K <sub>0</sub>	1.20 +/− 0.1
F	5.50 +/− 0.1
P <sub>1</sub>	8.00 +/− 0.1
W	12.00 +/− 0.3

- (I) Measured from centreline of sprocket hole to centreline of pocket.
- (II) Cumulative tolerance of 10 sprocket holes is ± 0.20.
- (III) Measured from centreline of sprocket hole to centreline of pocket.
- (IV) Other material available.
- (V) Typical SR of form tape Max 10<sup>9</sup> OHM/SQ

ALL DIMENSIONS IN MILLIMETRES UNLESS OTHERWISE STATED.

Note: For the most current drawing please refer to IR website at <http://www.irf.com/package/>

### Notes:

- ① Repetitive rating; pulse width limited by max. junction temperature.
- ② Starting T<sub>J</sub> = 25°C, L = 0.39mH, R<sub>G</sub> = 25Ω, I<sub>AS</sub> = 12A.
- ③ Pulse width ≤ 400μs; duty cycle ≤ 2%.
- ④ Rthjc is guaranteed by design
- ⑤ When mounted on 1 inch square 2 oz copper pad on 1.5x1.5 in. board of FR-4 material.

### Revision History

Date	Comments
08/05/2013	<ul style="list-style-type: none"> <li>• Updated the package drawing, on page 1.</li> <li>• Updated the package outline drawing, on page 8.</li> <li>• This drawing change is related to PCN "Hana-GTBF-GEM 5x6 PQFN Public."</li> </ul>

International  
 Rectifier

IR WORLD HEADQUARTERS: 101 N. Sepulveda Blvd., El Segundo, California 90245, USA  
 To contact International Rectifier, please visit <http://www.irf.com/whoto-call/>