

## Schematic for the NCP170AMX360GEVB Evaluation Board

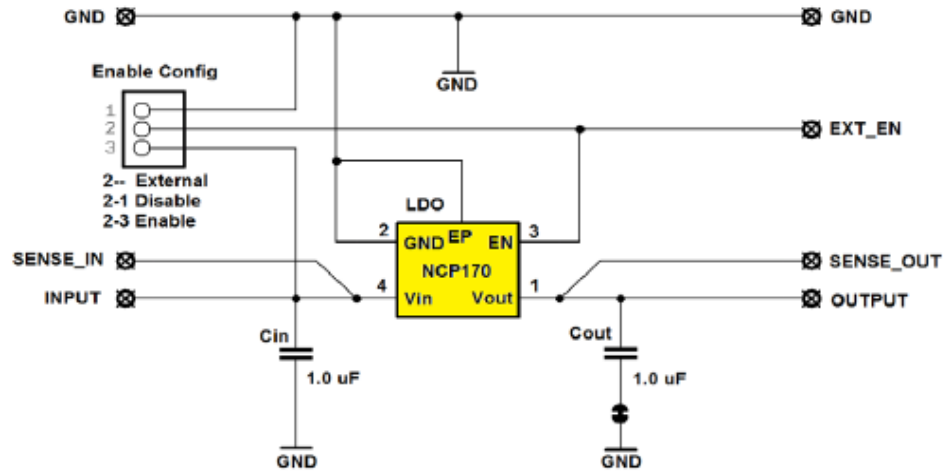

### Programming I/F

