

Data sheet | Item number: 2016-7111

1-conductor power distribution disconnect terminal block; 16 mm²; Push-in
CAGE CLAMP®; 16,00 mm²; gray

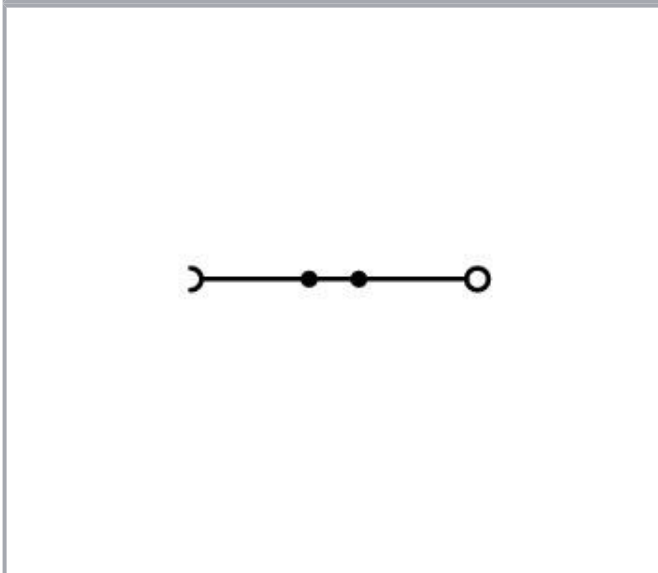

www.wago.com/2016-7111

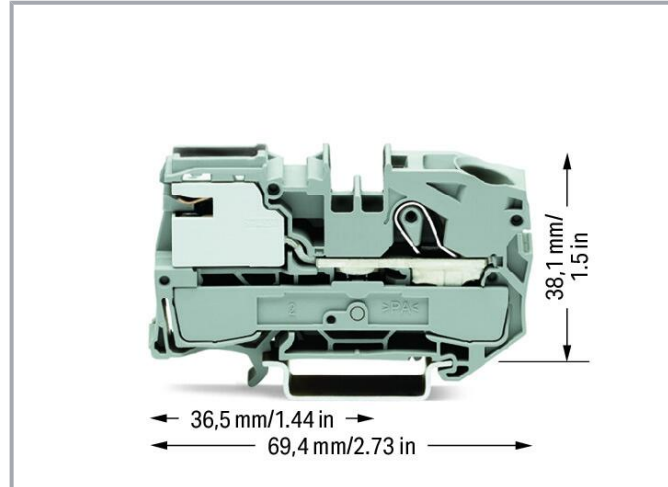
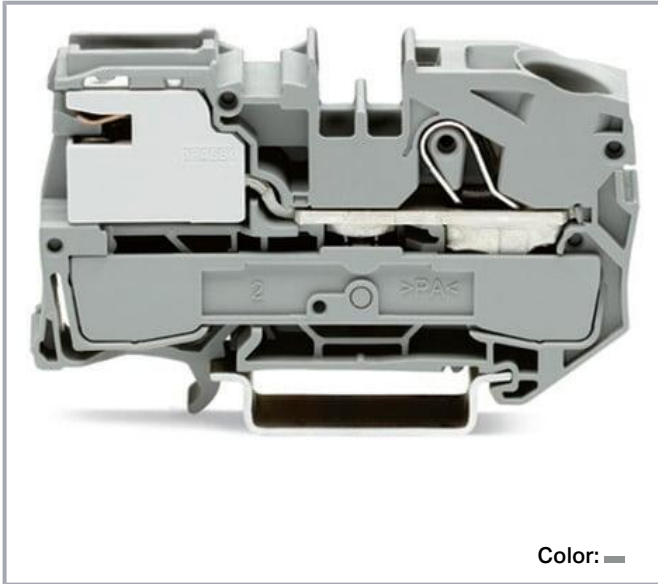

Data

Electrical data

Subject to changes. Please also observe the further product documentation!

WAGO GmbH & Co. KG
Hansastr. 27
32423 Minden
Phone: +49571 887-0 | Fax: +49571 887-169
Email: info.de@wago.com | Web: www.wago.com

Do you have any questions about our products?
We are always happy to take your call at +49 (571) 887-44222.



Ratings per IEC/EN

| | |
|---|---|
| Ratings per | IEC/EN 60947-7-1 |
| Nominal voltage (III/3) | 250 V |
| Rated impulse voltage (III/3) | 4 kV |
| Rated current | 72 A |
| Current at conductor cross-section (max.) mm ² | 80 A |
| Legend (ratings) | (III / 3) ≙ Overvoltage category III / Pollution degree 3 |

Power loss

| | |
|--|---------|
| Power loss, per pole (potential) | 2.177 W |
| Rated current I_N for specified power loss | 72 A |
| Resistance value for specified, current-dependent power loss | 0 Ω |

Connection data

| | |
|----------------------------|---|
| Connection points | 1 |
| Total number of potentials | 1 |
| Number of levels | 1 |
| Number of jumper slots | 2 |

Connection 1

| | |
|--|---|
| Connection technology | Push-in CAGE CLAMP® |
| Actuation type | Operating tool |
| Connectable conductor materials | Copper |
| Nominal cross-section | 16 mm ² |
| Solid conductor | 0.5 ... 16 mm ² / 20 ... 6 AWG |
| Solid conductor; push-in termination | 6 ... 16 mm ² / 14 ... 6 AWG |
| Fine-stranded conductor | 0.5 ... 25 mm ² / 20 ... 4 AWG |
| Fine-stranded conductor; with insulated ferrule | 0.5 ... 16 mm ² / 20 ... 6 AWG |
| Fine-stranded conductor; with ferrule; push-in termination | 6 ... 16 mm ² / 10 ... 6 AWG |
| Note (conductor cross-section) | Depending on the conductor characteristic, a conductor with a smaller cross-section can also be inserted via push-in termination. |
| Strip length | 18 ... 20 mm / 0.71 ... 0.79 inches |
| Wiring direction | Front-entry wiring |

Subject to changes. Please also observe the further product documentation!



Physical data

| | |
|-----------------------------------|------------------------|
| Width | 12 mm / 0.472 inches |
| Height | 69.4 mm / 2.732 inches |
| Depth from upper-edge of DIN-rail | 38.1 mm / 1.5 inches |

Mechanical Data

| | |
|---------------|---------------------|
| Mounting type | DIN-35 rail |
| Marking level | Center/side marking |

Material Data

| | |
|-----------------------------|--|
| Note (material data) | Information on material specifications can be found here |
| Color | gray |
| Material group | I |
| Insulation material | Polyamide (PA66) |
| Flammability class per UL94 | V0 |
| Fire load | 0.413 MJ |
| Weight | 24.9 g |

Environmental requirements

| | |
|----------------------------------|-----------------|
| Processing temperature | -35 ... +85 °C |
| Continuous operating temperature | -60 ... +105 °C |

Commercial data

| | |
|-----------------------|---------------|
| Product Group | 22 (TOPJOB S) |
| eCl@ss 10.0 | 27-14-11-38 |
| eCl@ss 9.0 | 27-14-11-38 |
| ETIM 8.0 | EC001257 |
| ETIM 7.0 | EC001257 |
| PU (SPU) | 25 pcs |
| Packaging type | box |
| Country of origin | PL |
| GTIN | 4044918964562 |
| Customs tariff number | 85369010000 |

Subject to changes. Please also observe the further product documentation!

WAGO GmbH & Co. KG
 Hansastr. 27
 32423 Minden
 Phone: +49571 887-0 | Fax: +49571 887-169
 Email: info.de@wago.com | Web: www.wago.com

Do you have any questions about our products?
 We are always happy to take your call at +49 (571) 887-44222.



Environmental Product Compliance

RoHS Compliance Status



Compliant, No Exemption

Approvals / Certificates



General approvals

| Logo | Approval | Additional Approval Text | Certificate name |
|--|---------------------------------------|--------------------------|------------------|
|  | CCA DEKRA Certification B.V. | EN 60947 | NTR NL-7881 |
|  | KEMA/KEUR DEKRA Certification B.V. | EN 60947 | 71-119271 |

Declarations of conformity and manufacturer's declarations

| Logo | Approval | Additional Approval Text | Certificate name |
|--|--|--------------------------|------------------|
|  | EU-Declaration of Conformity WAGO GmbH & Co. KG | - | - |
|  | UK-Declaration of Conformity WAGO GmbH & Co. KG | - | - |

Approvals for marine applications

| Logo | Approval | Additional Approval Text | Certificate name |
|--|--|--------------------------|------------------|
|  | ABS American Bureau of Shipping | - | 20-HG1941090-PDA |
|  | DNV GL Det Norske Veritas, Germanischer Lloyd | - | TAE00001V2 |

Subject to changes. Please also observe the further product documentation!

WAGO GmbH & Co. KG
 Hansastr. 27
 32423 Minden
 Phone: +49571 887-0 | Fax: +49571 887-169
 Email: info.de@wago.com | Web: www.wago.com

Do you have any questions about our products?
 We are always happy to take your call at +49 (571) 887-44222.

Required accessories

End plate

End plate



Item no.: 2016-7192

End and intermediate plate; 1 mm thick; orange

www.wago.com/2016-7192

Optional accessories

Jumpers

Jumper



Item no.: 2016-402

Jumper; 2-way; insulated; light gray

www.wago.com/2016-402



Item no.: 2016-405/011-000

Star point jumper; 3-way; insulated; light gray

www.wago.com/2016-405/011-000



Item no.: 2016-434

Jumper; from 1 to 4; insulated; light gray

www.wago.com/2016-434



Item no.: 2016-404

Jumper; 4-way; insulated; light gray

www.wago.com/2016-404



Item no.: 2016-405

Jumper; 5-way; insulated; light gray

www.wago.com/2016-405



Item no.: 2016-435

Jumper; from 1 to 5; insulated; light gray

www.wago.com/2016-435



Item no.: 2016-403

Jumper; 3-way; insulated; light gray

www.wago.com/2016-403



Item no.: 2016-433

Jumper; from 1 to 3; insulated; light gray

www.wago.com/2016-433

Tool

Operating tool



Item no.: 210-721

Operating tool; Blade: 5.5 x 0.8 mm; with a partially insulated shaft; multicoloured

www.wago.com/210-721

Lock-out

Locking system



Item no.: 2006-7300

Lock-out; prevents reclosing of slide link; Snap-in type; for 2006 and 2016 Series; orange

www.wago.com/2006-7300

Subject to changes. Please also observe the further product documentation!

WAGO GmbH & Co. KG

Hansastr. 27

32423 Minden

Phone: +49571 887-0 | Fax: +49571 887-169

Email: info.de@wago.com | Web: www.wago.com

Do you have any questions about our products?

We are always happy to take your call at +49 (571) 887-44222.

N-busbar

Mounting accessories

Item no.: 210-133

Busbar; tin-plated; 1000 mm long; Cu 10 mm x 3 mm; white

www.wago.com/210-133

Carrier rail

Mounting accessories

Item no.: 210-197

Steel carrier rail; 35 x 15 mm; 1.5 mm thick; 2 m long; slotted; similar to EN 60715; silver-colored

www.wago.com/210-197

Item no.: 210-198

Copper carrier rail; 35 x 15 mm; 2.3 mm thick; 2 m long; unslotted; according to EN 60715; copper-colored

www.wago.com/210-198

Item no.: 210-113

Steel carrier rail; 35 x 7.5 mm; 1 mm thick; 2 m long; unslotted; according to EN 60715; silver-colored

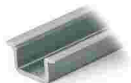
www.wago.com/210-113

Item no.: 210-118

Steel carrier rail; 35 x 15 mm; 2.3 mm thick; 2 m long; unslotted; according to EN 60715; silver-colored

www.wago.com/210-118

Item no.: 210-112

Steel carrier rail; 35 x 7.5 mm; 1 mm thick; 2 m long; slotted; according to EN 60715; "Hole width 25 mm; silver-colored

www.wago.com/210-112

Item no.: 210-114

Steel carrier rail; 35 x 15 mm; 1.5 mm thick; 2 m long; unslotted; similar to EN 60715; silver-colored

www.wago.com/210-114

Item no.: 210-115

Steel carrier rail; 35 x 7.5 mm; 1 mm thick; 2 m long; slotted; according to EN 60715; "Hole width 18 mm; silver-colored

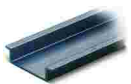
www.wago.com/210-115

Item no.: 210-196

Aluminum carrier rail; 35 x 8.2 mm; 1.6 mm thick; 2 m long; unslotted; similar to EN 60715; silver-colored

www.wago.com/210-196

Marking accessories

Marking strip

Item no.: 2009-110

Marking strips; for Smart Printer; on reel; not stretchable; plain; snap-on type; white

www.wago.com/2009-110

Marker carrier

Item no.: 2009-198

Adaptor; gray

www.wago.com/2009-198

Marker

Item no.: 2009-115/000-002

WMB-Inline; for Smart Printer; 1500 pieces on roll; stretchable 5 - 5.2 mm; plain; snap-on type; yellow

www.wago.com/2009-115/000-002

Subject to changes. Please also observe the further product documentation!

WAGO GmbH & Co. KG

Hansastr. 27





32423 Minden

Phone: +49571 887-0 | Fax: +49571 887-169

 Email: info.de@wago.com | Web: www.wago.com

Do you have any questions about our products?

We are always happy to take your call at +49 (571) 887-44222.

| | | |
|---|---|--|
|  | Item no.: 2009-115/000-007 WMB-Inline; for Smart Printer; 1500 pieces on roll; stretchable 5 - 5.2 mm; plain; snap-on type; gray | www.wago.com/2009-115/000-007 |
|  | Item no.: 2009-115/000-017 WMB-Inline; for Smart Printer; 1500 pieces on roll; stretchable 5 - 5.2 mm; plain; snap-on type; light green | www.wago.com/2009-115/000-017 |
|  | Item no.: 2009-115/000-023 WMB-Inline; for Smart Printer; 1500 pieces on roll; stretchable 5 - 5.2 mm; plain; snap-on type; green | www.wago.com/2009-115/000-023 |
|  | Item no.: 2009-115/000-024 WMB-Inline; for Smart Printer; 1500 pieces on roll; stretchable 5 - 5.2 mm; plain; snap-on type; violet | www.wago.com/2009-115/000-024 |
| | Item no.: 2009-145/000-006 Mini-WSB Inline; for Smart Printer; 1700 pieces on roll; stretchable 5 - 5.2 mm; plain; snap-on type; blue | www.wago.com/2009-145/000-006 |
| | Item no.: 2009-145 Mini-WSB Inline; for Smart Printer; 1700 pieces on roll; stretchable 5 - 5.2 mm; plain; snap-on type; white | www.wago.com/2009-145 |
| | Item no.: 2009-145/000-002 Mini-WSB Inline; for Smart Printer; 1700 pieces on roll; stretchable 5 - 5.2 mm; plain; snap-on type; yellow | www.wago.com/2009-145/000-002 |
| | Item no.: 2009-145/000-007 Mini-WSB Inline; for Smart Printer; 1700 pieces on roll; stretchable 5 - 5.2 mm; plain; snap-on type; gray | www.wago.com/2009-145/000-007 |
| | Item no.: 2009-145/000-005 Mini-WSB Inline; for Smart Printer; 1700 pieces on roll; stretchable 5 - 5.2 mm; plain; snap-on type; red | www.wago.com/2009-145/000-005 |
| | Item no.: 2009-145/000-012 Mini-WSB Inline; for Smart Printer; 1700 pieces on roll; stretchable 5 - 5.2 mm; plain; snap-on type; orange | www.wago.com/2009-145/000-012 |
| | Item no.: 2009-145/000-023 Mini-WSB Inline; for Smart Printer; 1700 pieces on roll; stretchable 5 - 5.2 mm; plain; snap-on type; green | www.wago.com/2009-145/000-023 |
| | Item no.: 2009-145/000-024 Mini-WSB Inline; for Smart Printer; 1700 pieces on roll; stretchable 5 - 5.2 mm; plain; snap-on type; violet | www.wago.com/2009-145/000-024 |
|  | Item no.: 2009-115 WMB-Inline; for Smart Printer; 1500 pieces on roll; stretchable 5 - 5.2 mm; plain; snap-on type; white | www.wago.com/2009-115 |

Subject to changes. Please also observe the further product documentation!



Item no.: 248-501/000-006
Mini-WSB marking card; as card; not stretchable; plain; snap-on type; blue

www.wago.com/248-501/000-006



Item no.: 248-501/000-007
Mini-WSB marking card; as card; not stretchable; plain; snap-on type; gray

www.wago.com/248-501/000-007



Item no.: 248-501/000-002
Mini-WSB marking card; as card; not stretchable; plain; snap-on type; yellow

www.wago.com/248-501/000-002



Item no.: 248-501/000-012
Mini-WSB marking card; as card; not stretchable; plain; snap-on type; orange

www.wago.com/248-501/000-012



Item no.: 248-501
Mini-WSB marking card; as card; not stretchable; plain; snap-on type; white

www.wago.com/248-501



Item no.: 248-501/000-017
Mini-WSB marking card; as card; not stretchable; plain; snap-on type; light green

www.wago.com/248-501/000-017



Item no.: 248-501/000-005
Mini-WSB marking card; as card; not stretchable; plain; snap-on type; red

www.wago.com/248-501/000-005



Item no.: 248-501/000-024
Mini-WSB marking card; as card; not stretchable; plain; snap-on type; violet

www.wago.com/248-501/000-024



Item no.: 248-501/000-023
Mini-WSB marking card; as card; not stretchable; plain; snap-on type; green

www.wago.com/248-501/000-023



Item no.: 793-5501/000-007
WMB marking card; as card; for terminal block width 5 - 17.5 mm; stretchable 5 - 5.2 mm; plain; snap-on type; gray

www.wago.com/793-5501/000-007



Item no.: 793-5501/000-012
WMB marking card; as card; for terminal block width 5 - 17.5 mm; stretchable 5 - 5.2 mm; plain; snap-on type; orange

www.wago.com/793-5501/000-012

Item no.: 793-5501/000-017

Subject to changes. Please also observe the further product documentation!



WMB marking card; as card; for terminal block width 5 - 17.5 mm; stretchable 5 - 5.2 mm; plain; snap-on type; light green www.wago.com/793-5501/000-017



Item no.: 793-5501/000-023
WMB marking card; as card; for terminal block width 5 - 17.5 mm; stretchable 5 - 5.2 mm; plain; snap-on type; green www.wago.com/793-5501/000-023



Item no.: 793-5501/000-024
WMB marking card; as card; for terminal block width 5 - 17.5 mm; stretchable 5 - 5.2 mm; plain; snap-on type; violet www.wago.com/793-5501/000-024



Item no.: 793-501/000-002
WMB marking card; as card; not stretchable; plain; snap-on type; yellow www.wago.com/793-501/000-002



Item no.: 793-501/000-007
WMB marking card; as card; not stretchable; plain; snap-on type; gray www.wago.com/793-501/000-007



Item no.: 793-501/000-017
WMB marking card; as card; not stretchable; plain; snap-on type; light green www.wago.com/793-501/000-017

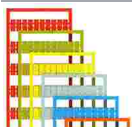

Item no.: 793-501/000-012
WMB marking card; as card; not stretchable; plain; snap-on type; orange www.wago.com/793-501/000-012



Item no.: 793-501/000-023
WMB marking card; as card; not stretchable; plain; snap-on type; green www.wago.com/793-501/000-023

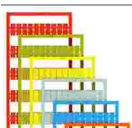

Item no.: 793-501/000-006
WMB marking card; as card; not stretchable; plain; snap-on type; blue www.wago.com/793-501/000-006

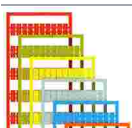

Item no.: 793-501/000-005
WMB marking card; as card; not stretchable; plain; snap-on type; red www.wago.com/793-501/000-005



Item no.: 793-501
WMB marking card; as card; not stretchable; plain; snap-on type; white www.wago.com/793-501

Subject to changes. Please also observe the further product documentation!



Item no.: 793-501/000-024
WMB marking card; as card; not stretchable; plain; snap-on type; violet

www.wago.com/793-501/000-024



Item no.: 793-5501/000-005
WMB marking card; as card; for terminal block width 5 - 17.5 mm; stretchable 5 - 5.2 mm; plain; snap-on type; red

www.wago.com/793-5501/000-005



Item no.: 793-5501/000-002
WMB marking card; as card; for terminal block width 5 - 17.5 mm; stretchable 5 - 5.2 mm; plain; snap-on type; yellow

www.wago.com/793-5501/000-002



Item no.: 793-5501/000-006
WMB marking card; as card; for terminal block width 5 - 17.5 mm; stretchable 5 - 5.2 mm; plain; snap-on type; blue

www.wago.com/793-5501/000-006



Item no.: 793-5501
WMB marking card; as card; for terminal block width 5 - 17.5 mm; stretchable 5 - 5.2 mm; plain; snap-on type; white

www.wago.com/793-5501



Item no.: 2009-115/000-012
WMB-Inline; for Smart Printer; 1500 pieces on roll; stretchable 5 - 5.2 mm; plain; snap-on type; orange

www.wago.com/2009-115/000-012



Item no.: 2009-115/000-006
WMB-Inline; for Smart Printer; 1500 pieces on roll; stretchable 5 - 5.2 mm; plain; snap-on type; blue

www.wago.com/2009-115/000-006

Group marker carrier



Item no.: 2009-193
Group marker carrier; gray

www.wago.com/2009-193



Item no.: 2009-192
Group marker carrier; gray

www.wago.com/2009-192



Item no.: 2009-191
Group marker carrier; gray

www.wago.com/2009-191

Mounting

Cover carrier



Item no.: 709-169
Cover carrier; Type 3; gray

www.wago.com/709-169

Cover



Item no.: 709-156
Cover; Type 3; suitable for cover carrier, type 3; 1 m long; transparent

www.wago.com/709-156

Subject to changes. Please also observe the further product documentation!

Mounting accessories

**Item no.: 2009-305**

Busbar carrier; with end stop function and detachable separator plate; for DIN 35 rail; 7.5 mm thick; blue

www.wago.com/2009-305**Item no.: 2009-304**

Busbar carrier; not suitable for use as end stop; for DIN 35 rail; 1.5 mm thick; blue

www.wago.com/2009-304

Ferrule

Ferrule

**Item no.: 216-210**Ferrule; Sleeve for 16 mm² / AWG 6; insulated; electro-tin plated; electrolytic copper; gastight crimped; acc. to DIN 46228, Part 4/09.90; bluewww.wago.com/216-210**Item no.: 216-284**Ferrule; Sleeve for 1.5 mm² / AWG 16; insulated; electro-tin plated; electrolytic copper; gastight crimped; acc. to DIN 46228, Part 4/09.90; blackwww.wago.com/216-284**Item no.: 216-286**Ferrule; Sleeve for 2.5 mm² / AWG 14; insulated; electro-tin plated; electrolytic copper; gastight crimped; acc. to DIN 46228, Part 4/09.90; bluewww.wago.com/216-286**Item no.: 216-287**Ferrule; Sleeve for 4 mm² / AWG 12; insulated; electro-tin plated; electrolytic copper; gastight crimped; acc. to DIN 46228, Part 4/09.90; graywww.wago.com/216-287**Item no.: 216-288**Ferrule; Sleeve for 6 mm² / AWG 10; insulated; electro-tin plated; electrolytic copper; gastight crimped; acc. to DIN 46228, Part 4/09.90; yellowwww.wago.com/216-288**Item no.: 216-289**Ferrule; Sleeve for 10 mm² / AWG 8; insulated; electro-tin plated; electrolytic copper; gastight crimped; acc. to DIN 46228, Part 4/09.90; redwww.wago.com/216-289

Downloads

Documentation

Bid Text

| | | | |
|---------------------------|-------------|-----------------|----------|
| 2016-7111 X81 - Datei | 2019 Apr 17 | xml 3.9 kB | Download |
| 2016-7111 docx - Datei | 2019 Apr 15 | docx 15.1 kB | Download |

Additional Information

| | | |
|---|---------------|----------|
| Technical Section Technical explanations | pdf 2.2 MB | Download |
|---|---------------|----------|

CAD/CAE-Data

Subject to changes. Please also observe the further product documentation!

WAGO GmbH & Co. KG
 Hansastr. 27
 32423 Minden
 Phone: +49571 887-0 | Fax: +49571 887-169
 Email: info.de@wago.com | Web: www.wago.com

Do you have any questions about our products?
 We are always happy to take your call at +49 (571) 887-44222.

CAE data

| | | |
|-----------------------------|---------------------|--------------------------|
| EPLAN Data Portal 2016-7111 | URL | Download |
| WSCAD Universe 2016-7111 | URL | Download |
| ZUKEN Portal 2016-7111 | URL | Download |

CAD data

| | | |
|------------------------|---------------------|--------------------------|
| 2D/3D Models 2016-7111 | URL | Download |
|------------------------|---------------------|--------------------------|

Environmental Product Compliance

Compliance Search

| | | |
|--|---------------------|--------------------------|
| Environmental Product Compliance 2016-7111 | URL | Download |
| 1-conductor power distribution disconnect terminal block; 16 mm ² ; Push-in CAGE CLAMP®; 16,00 mm ² ; gray | | |

Installation Notes

Conductor termination

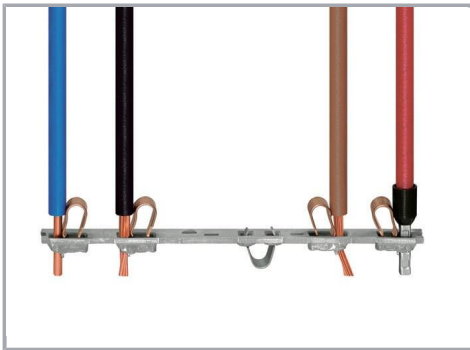

All conductor types at a glance

Busbar

Subject to changes. Please also observe the further product documentation!

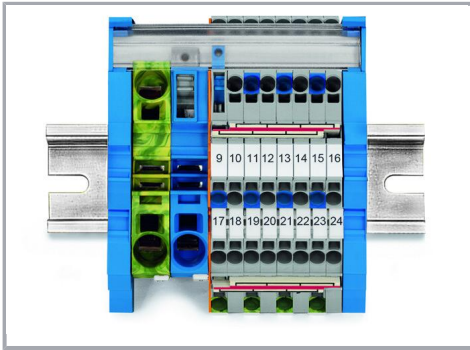

Mounting busbars on busbar carriers: Insert busbar ends onto large busbar carriers (2009-305) or onto supply terminal blocks with an integrated busbar carrier.

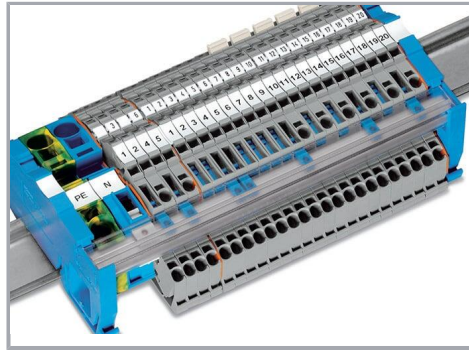

The busbar transparent cover (Item No. 777-303) protects the busbar against accidental contact and makes it easy to see which terminal blocks are connected to the busbar.

Product family

TOPJOB® S

TOPJOB® S: In various industrial applications and modern building installations, WAGO's wide and versatile range of rail-mount terminal blocks provides more than just reliable electrical connections.

[Show all products from the family](#)

Subject to changes. Please also observe the further product documentation!

WAGO GmbH & Co. KG
Hansastr. 27
32423 Minden
Phone: +49571 887-0 | Fax: +49571 887-169
Email: info.de@wago.com | Web: www.wago.com

Do you have any questions about our products?
We are always happy to take your call at +49 (571) 887-44222.