

**Data sheet | Item number: 2086-3227/300-000**

THR PCB terminal block; push-button; 1.5 mm<sup>2</sup>; Pin spacing 5 mm; 7-pole;  
Push-in CAGE CLAMP®; Solder pin length 1.5 mm; 1,50 mm<sup>2</sup>; black

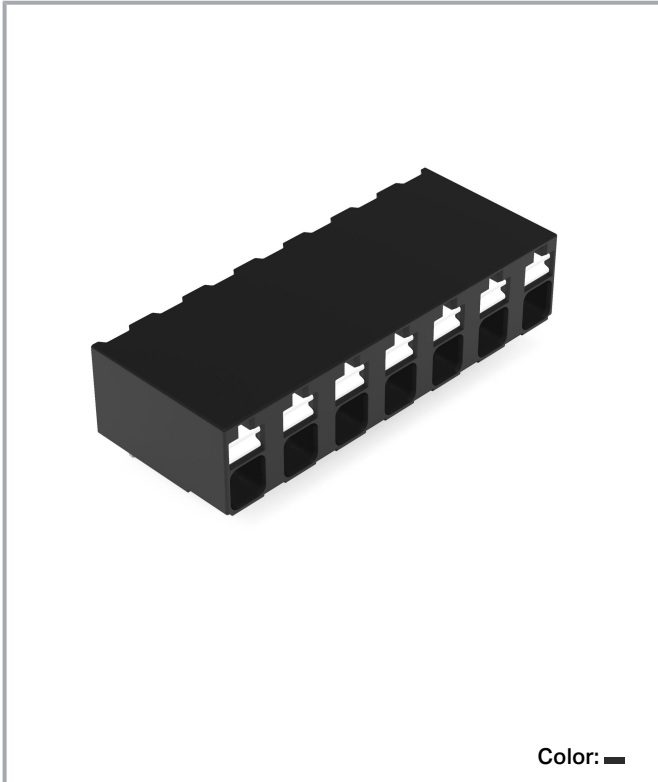

[www.wago.com/2086-3227/300-000](http://www.wago.com/2086-3227/300-000)



Subject to changes. Please also observe the further product documentation!

WAGO Corporation  
Germantown, WI 53022  
Phone: 1-800-DIN-RAIL (346-7245) | Fax: (262) 255-6222  
Email: [info.us@wago.com](mailto:info.us@wago.com) | Web: [www.wago.us](http://www.wago.us)

Do you have any questions about our products?  
We are always happy to take your call at (262) 255-6222 or 1 800-DIN-RAIL.

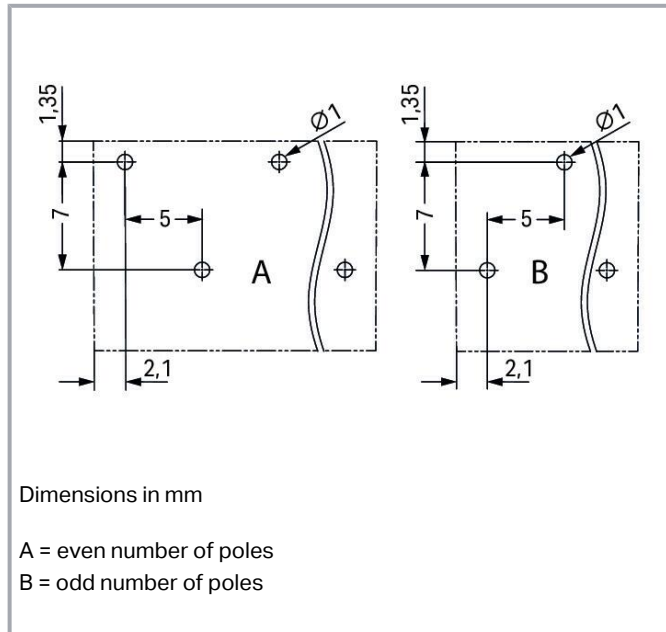
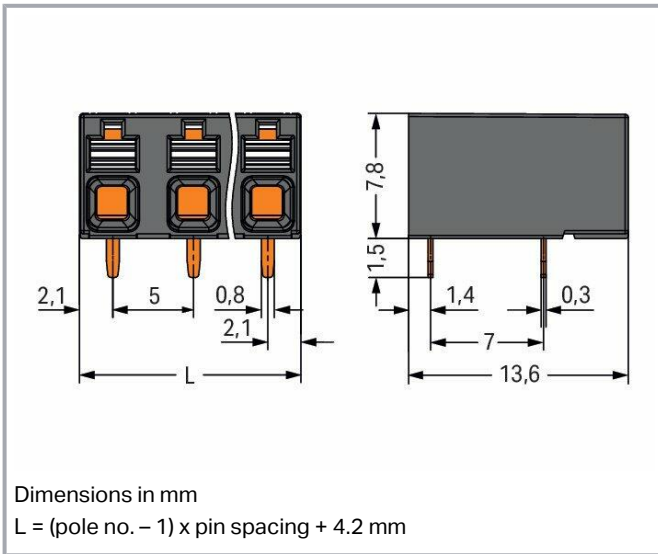

### Item description

- Ideal for compact device connection, panel feedthrough and tight spaces
- Push-in CAGE CLAMP® allows push-in termination of solid and fine-stranded conductors with ferrules
- SMD and THR variants available

Subject to changes. Please also observe the further product documentation!

WAGO Corporation  
 Germantown, WI 53022  
 Phone: 1-800-DIN-RAIL (346-7245) | Fax: (262) 255-6222  
 Email: [info.us@wago.com](mailto:info.us@wago.com) | Web: [www.wago.us](http://www.wago.us)

Do you have any questions about our products?  
 We are always happy to take your call at (262) 255-6222 or 1 800-DIN-RAIL.



- Delivery in tape-and-reel packaging for full integration into SMT soldering process
- Push-button moves in direction of conductor connection
- Conductor connection and mating direction both parallel and perpendicular to the PCB
- Choice of double pin spacing or alternating pin spacing, 3.5 and 5 mm pin spacing

## Data

### Electrical data

### IEC Approvals

Ratings per	IEC/EN 60664-1
Rated voltage (III / 3)	500 V
Rated surge voltage (III/3)	6 kV
Rated voltage (III/2)	630 V
Rated surge voltage (III/2)	6 kV
Nominal voltage (II/2)	1000 V
Rated surge voltage (II/2)	6 kV
Rated current	17.5 A
Legend (ratings)	(III / 2) $\hat{=}$ Overvoltage category III / Pollution degree 2

### UL Approvals

Approvals per	UL 1059
Rated voltage UL (Use Group B)	300 V
Rated current UL (Use Group B)	10 A
Rated voltage UL (Use Group C)	300 V
Rated current UL (Use Group C)	10 A
Rated voltage UL (Use Group D)	300 V
Rated current UL (Use Group D)	10 A

### CSA Approvals

Approvals per	CSA
Rated voltage CSA (Use Group B)	300 V
Rated current CSA (Use Group B)	10 A
Rated voltage CSA (Use Group D)	300 V
Rated current CSA (Use Group D)	10 A

Subject to changes. Please also observe the further product documentation!

WAGO Corporation  
 Germantown, WI 53022  
 Phone: 1-800-DIN-RAIL (346-7245) | Fax: (262) 255-6222  
 Email: [info.us@wago.com](mailto:info.us@wago.com) | Web: [www.wago.us](http://www.wago.us)

Do you have any questions about our products?  
 We are always happy to take your call at (262) 255-6222 or 1 800-DIN-RAIL.



## Connection data

Total number of potentials	7
Number of connection types	1
Number of levels	1

## Connection 1

Connection technology	Push-in CAGE CLAMP®
Actuation type	Push-button
Solid conductor	0.14 ... 1.5 mm <sup>2</sup> / 24 ... 16 AWG
Fine-stranded conductor	0.14 ... 1.5 mm <sup>2</sup> / 24 ... 16 AWG
Fine-stranded conductor; with insulated ferrule	0.25 ... 0.75 mm <sup>2</sup>
Fine-stranded conductor; with uninsulated ferrule	0.25 ... 1.5 mm <sup>2</sup>
Strip length	8 ... 9 mm / 0.31 ... 0.35 inch
Conductor connection direction to PCB	0°
Number of poles	7

## Physical data

Pin spacing	5 mm / 0.197 inch
Width	34.2 mm / 1.346 inch
Height	9.3 mm / 0.366 inch
Height from the surface	7.8 mm / 0.307 inch
Depth	13.6 mm / 0.535 inch
Solder pin length	1.5 mm
Solder pin dimensions	0.3 x 0.8 mm
Plated through-hole diameter (THR)	1 <sup>(+0.1)</sup> mm

## PCB contact

PCB Contact	THR
Solder pin arrangement	over the entire terminal strip (staggered)
Number of solder pins per potential	1

## Material data

Color	black
Insulation material	Polyphthalamide (PPA GF)

Subject to changes. Please also observe the further product documentation!

Flammability class per UL94	V0
Clamping spring material	Chrome nickel spring steel (CrNi)
Contact material	Electrolytic copper (E <sub>Cu</sub> )
Contact plating	tin-plated
Weight	4.1 g

### Environmental requirements



Limit temperature range	-60 ... +105 °C
-------------------------	-----------------

### Commercial data

PU (SPU)	96 Stück
Packaging type	BOX
Country of origin	CH
GTIN	4055144090123
Customs tariff number	85369010000

### Approvals / Certificates

#### Country specific Approvals

Logo	Approval	Additional Approval Text	Certificate name
	<b>CB</b> DEKRA Certification B.V.	IEC 60947-7-4	NL-74022
	<b>CSA</b> DEKRA Certification B.V.	C22.2	80060692
	<b>KEMA/KEUR</b> DEKRA Certification B.V.	EN 60947-7-4	71- 119449

#### UL-Approvals

Logo	Approval	Additional Approval Text	Certificate name
	<b>UL</b> Underwriters Laboratories Inc.	UL 1059	E45172



Subject to changes. Please also observe the further product documentation!

## Optional accessories













### Tools

Operating tool		
	<b>Item no.: 210-719</b> Operating tool; Blade: 2.5 x 0.4 mm; with a partially insulated shaft	<a href="http://www.wago.com/210-719">www.wago.com/210-719</a>

### Testing accessories

Testing accessories		
	<b>Item no.: 735-500</b> Test pin; 1 mm Ø; with solder connection for test wire	<a href="http://www.wago.com/735-500">www.wago.com/735-500</a>
	<b>Item no.: 859-500</b> Test pin; 1 mm Ø; with solder connection for test wire	<a href="http://www.wago.com/859-500">www.wago.com/859-500</a>

### Ferrules

Ferrule		
	<b>Item no.: 216-101</b> Ferrule; Sleeve for 0.5 mm <sup>2</sup> / AWG 22; uninsulated; electro-tin plated; silver-colored	<a href="http://www.wago.com/216-101">www.wago.com/216-101</a>
	<b>Item no.: 216-104</b> Ferrule; Sleeve for 1.5 mm <sup>2</sup> / AWG 16; uninsulated; electro-tin plated; silver-colored	<a href="http://www.wago.com/216-104">www.wago.com/216-104</a>
	<b>Item no.: 216-102</b> Ferrule; Sleeve for 0.75 mm <sup>2</sup> / AWG 20; uninsulated; electro-tin plated; silver-colored	<a href="http://www.wago.com/216-102">www.wago.com/216-102</a>
	<b>Item no.: 216-103</b> Ferrule; Sleeve for 1 mm <sup>2</sup> / AWG 18; uninsulated; electro-tin plated	<a href="http://www.wago.com/216-103">www.wago.com/216-103</a>
	<b>Item no.: 216-142</b> Ferrule; Sleeve for 0.75 mm <sup>2</sup> / 18 AWG; uninsulated; electro-tin plated; electrolytic copper; gastight crimped; acc. to DIN 46228, Part 1/08.92	<a href="http://www.wago.com/216-142">www.wago.com/216-142</a>
	<b>Item no.: 216-132</b> Ferrule; Sleeve for 0.34 mm <sup>2</sup> / AWG 24; uninsulated; electro-tin plated	<a href="http://www.wago.com/216-132">www.wago.com/216-132</a>
	<b>Item no.: 216-121</b> Ferrule; Sleeve for 0.5 mm <sup>2</sup> / AWG 22; uninsulated; electro-tin plated; silver-colored	<a href="http://www.wago.com/216-121">www.wago.com/216-121</a>
	<b>Item no.: 216-143</b> Ferrule; Sleeve for 1 mm <sup>2</sup> / AWG 18; uninsulated; electro-tin plated; electrolytic copper; gastight crimped; acc. to DIN 46228, Part 1/08.92	<a href="http://www.wago.com/216-143">www.wago.com/216-143</a>
	<b>Item no.: 216-131</b> Ferrule; Sleeve for 0.25 mm <sup>2</sup> / AWG 24; uninsulated; electro-tin plated; silver-colored	<a href="http://www.wago.com/216-131">www.wago.com/216-131</a>
	<b>Item no.: 216-141</b> Ferrule; Sleeve for 0.5 mm <sup>2</sup> / 20 AWG; uninsulated; electro-tin plated; electrolytic copper; gastight crimped; acc. to DIN 46228, Part 1/08.92	<a href="http://www.wago.com/216-141">www.wago.com/216-141</a>
	<b>Item no.: 216-152</b> Ferrule; Sleeve for 0.34 mm <sup>2</sup> / AWG 24; uninsulated; electro-tin plated	<a href="http://www.wago.com/216-152">www.wago.com/216-152</a>
	<b>Item no.: 216-202</b>	

Subject to changes. Please also observe the further product documentation!



Ferrule; Sleeve for 0.75 mm<sup>2</sup> / 18 AWG; insulated; electro-tin plated; gray

[www.wago.com/216-202](http://www.wago.com/216-202)

<b>Item no.: 216-151</b> Ferrule; Sleeve for 0.25 mm <sup>2</sup> / AWG 24; uninsulated; electro-tin plated	<a href="http://www.wago.com/216-151">www.wago.com/216-151</a>
<b>Item no.: 216-144</b> Ferrule; Sleeve for 1.5 mm <sup>2</sup> / AWG 16; uninsulated; electro-tin plated; electrolytic copper; gastight crimped; acc. to DIN 46228, Part 1/08.92; silver-colored	<a href="http://www.wago.com/216-144">www.wago.com/216-144</a>
<b>Item no.: 216-201</b> Ferrule; Sleeve for 0.5 mm <sup>2</sup> / 20 AWG; insulated; electro-tin plated; white	<a href="http://www.wago.com/216-201">www.wago.com/216-201</a>
<b>Item no.: 216-241</b> Ferrule; Sleeve for 0.5 mm <sup>2</sup> / 20 AWG; insulated; electro-tin plated; electrolytic copper; gastight crimped; acc. to DIN 46228, Part 4/09.90; white	<a href="http://www.wago.com/216-241">www.wago.com/216-241</a>
<b>Item no.: 216-242</b> Ferrule; Sleeve for 0.75 mm <sup>2</sup> / 18 AWG; insulated; electro-tin plated; electrolytic copper; gastight crimped; acc. to DIN 46228, Part 4/09.90; gray	<a href="http://www.wago.com/216-242">www.wago.com/216-242</a>
<b>Item no.: 216-301</b> Ferrule; Sleeve for 0.25 mm <sup>2</sup> / AWG 24; insulated; electro-tin plated; yellow	<a href="http://www.wago.com/216-301">www.wago.com/216-301</a>
<b>Item no.: 216-302</b> Ferrule; Sleeve for 0.34 mm <sup>2</sup> / 22 AWG; insulated; electro-tin plated; green	<a href="http://www.wago.com/216-302">www.wago.com/216-302</a>

## Downloads

### Documentation

#### Additional Information

Technical explanations	Apr 3, 2019	pdf 2.0 MB	Download
THR Soldering Process		pdf 548.2 kB	Download

## CAD files

### CAD data

2D/3D Models 2086-3227/300-000	URL	Download
--------------------------------	-----	----------

### CAE data

ZUKEN Portal 2086-3227/300-000	URL	Download
--------------------------------	-----	----------

## Environmental Product Compliance

### Compliance Search

Subject to changes. Please also observe the further product documentation!

WAGO Corporation  
 Germantown, WI 53022  
 Phone: 1-800-DIN-RAIL (346-7245) | Fax: (262) 255-6222  
 Email: [info.us@wago.com](mailto:info.us@wago.com) | Web: [www.wago.us](http://www.wago.us)

Do you have any questions about our products?  
 We are always happy to take your call at (262) 255-6222 or 1 800-DIN-RAIL.

Environmental Product Compliance 2086-3227/300-000

THR PCB terminal block; push-button; 1.5 mm<sup>2</sup>; Pin spacing 5 mm; 7-pole; Push-in  
CAGE CLAMP®; Solder pin length 1.5 mm; 1,50 mm<sup>2</sup>; black

---

## Installation Notes

### Conductor termination



Inserting solid conductor via push-in termination.

### Conductor removal



Removing fine-stranded conductors via push-buttons.

### Conductor termination

Subject to changes. Please also observe the further product documentation!

---



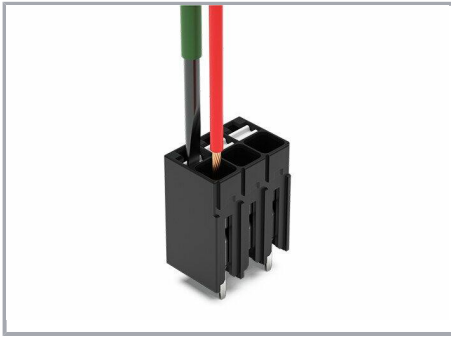

Inserting and removing fine-stranded conductors via push-buttons.

#### Testing

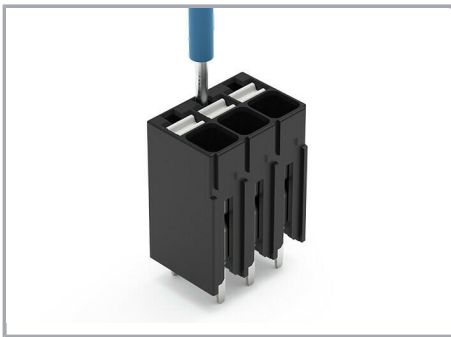

Testing via 1 mm Ø test pin.

Touch contact with current bar.

#### Marking



Pole marking via direct marking perpendicular to conductor entry.

Subject to changes. Please also observe the further product documentation!