

LTM4681

PolyPhase Single Output Step-Down μ Module Regulator with Digital PSM: 4 \times LTM4681 at 480A

DESCRIPTION

Demonstration circuit DC3082A-C features the **LTM®4681**: the wide input and output voltage range, high efficiency and power density, high current PolyPhase® single output DC/DC step-down μ Module® regulator with digital power system management. DC3082A-C is configured as 16-phase single output using 4 \times LTM4681. The factory default input voltage is 12V typical, output voltage is 1V at 480A typical or 500A peak with recommended 400LFM forced airflow. The demo board output voltages can be adjusted from 0.6V to 1V. Programming the output voltages to any value that is greater than 1V, requires derating output current based on thermal derating curves provided in the data sheet of the LTM4681. Heat sink or other appropriate electronic cooling systems can also be used in conjunction with forced airflow to further optimize the output power when the output is on and loaded with maximum output current. The factory default switching frequency is preset at 350kHz typical. DC3082A-C comes with PMBus interface and digital power system management functions. An onboard 12-pin connector is available for users to connect the dongle DC1613A to the demo board, provides an easy way to communicate and program the part using LTpowerPlay® software development tool. LTpowerPlay

software and I²C/PMBus/SMBus dongle DC1613A allows users to monitor real time telemetry of input and output voltages, input and output current, switching frequency, internal IC die temperatures, power stage component temperatures and fault logs. Programmable parameters include device address, output voltages, control loop compensation, switching frequency, phase interleaving, DCM or CCM mode of operation, digital soft-start, sequencing and time based shutdown, fault responses to input and output overvoltage, output overcurrent, IC die and power component overtemperature.

The LTM4681 is available in a thermally enhanced, low profile 330-Lead (15mm \times 22mm \times 8.17mm) BGA package. It is recommended to read the data sheet and this demo manual of LTM4681 prior to use or making any hardware changes to DC3082A-C.

LTpowerPlay software can be downloaded [here](#).

USB to PMBus Controller Dongle DC1613A for use with LTpowerPlay is available [here](#).

Design files for this circuit board are available.

All registered trademarks and trademarks are the property of their respective owners.

BOARD PHOTO

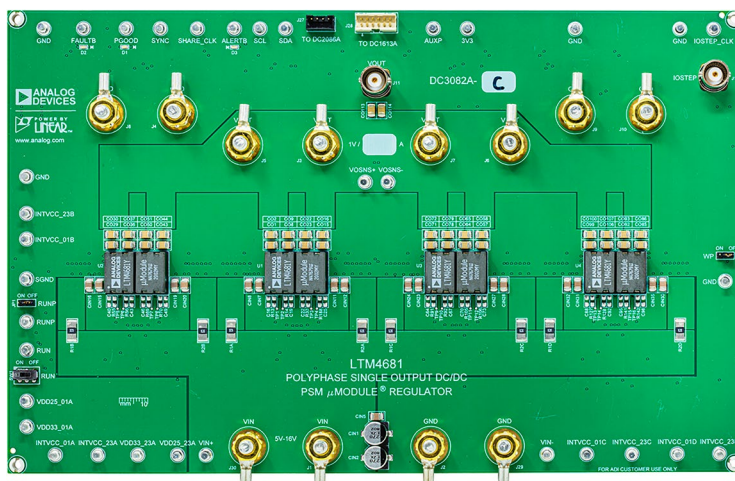

DEMO MANUAL

DC3082A-C

PERFORMANCE SUMMARY Specifications are at $T_A = 25^\circ\text{C}$

DC3082A-C: 16-Phase Single Output

PARAMETER	CONDITIONS	MIN	TYP	MAX	UNIT
Input Voltage V_{IN} Range		4.5	12	16	V
Demo Board Default Output Voltage V_{OUT}	$f_{SW} = 350\text{kHz}$, $V_{IN} = 12\text{V}$, $I_{OUT} = 480\text{A}$		1		V
Switching Frequency f_{SW}	Factory Default Switching Frequency		350		kHz
Maximum Continuous Output Current I_{OUT}	$V_{IN} = 12\text{V}$, $V_{OUT} = 0.6\text{V to } 1\text{V}$, $f_{SW} = 350\text{kHz}$, $V_{BIAS} = 5.5\text{V}$ (RUNP: ON), Forced Airflow = 400LFM		480	500	A
Efficiency	$f_{SW} = 350\text{kHz}$, $V_{IN} = 12\text{V}$, $V_{OUT} = 1\text{V}$, $I_{OUT} = 480\text{A}$, $V_{BIAS} = 5.5\text{V}$ (RUNP: ON), No Forced Airflow, No Heat Sink		89.2*		%

*Fast pulse current used for efficiency test.

QUICK START PROCEDURE

Demonstration circuit DC3082A-C is easy to set up to evaluate the performance of the LTM4681. Please refer to Figure 1 for proper measurement equipment setup and follow the test procedures below.

1. With power off, connect the input power supply between V_{IN} (J1) and GND (J2). Set the input voltage supply to 0V.
2. Connect the load between V_{OUT} (J3, J5, J6, J7) and GND (J4, J8, J9, J10). Preset the load to 0A.
3. Connect the DMM between the input test points: V_{IN}^+ (E1) and V_{IN}^- (E2) to monitor the input voltage. Connect a DMM between V_{OSNS}^+ (E3) and

V_{OSNS}^- (E4) to monitor the DC output voltage. V_{OSNS}^+ and V_{OSNS}^- test points are Kelvin sensed directly across CO113 to provide accurate measurement of output voltage. Do not apply load current or connect the scope probe ground leads to any of the above test points to avoid damage to the regulator.

4. Prior power up the DC3082A-C, check the default position of the jumpers and switches (refer to Table 1).

Table 1. Demo Board Default Switches and Jumpers Position

SWITCH/JUMPER NAME	SW1	JP1	JP2
Description	RUN	RUNP	WP
Position	OFF	ON	OFF

QUICK START PROCEDURE

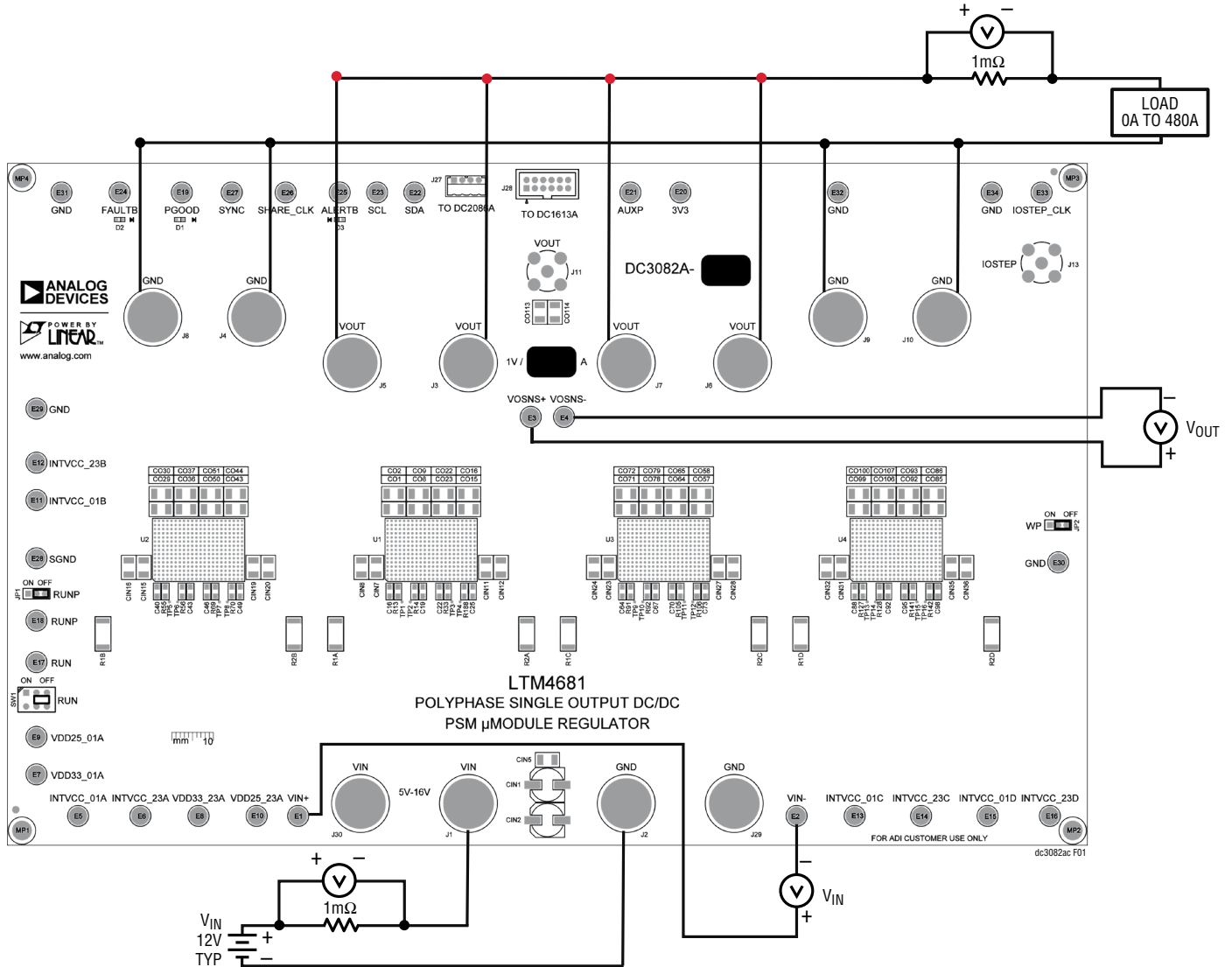

Figure 1. Proper Measurement Equipment Setup for DC3082A-C

QUICK START PROCEDURE

- Turn on the power supply at the input. Slowly increasing the input voltage from 0V to 12V typical. Measure and make sure the input supply voltage is 12V and flip SW1 (RUN) to the “ON” position. The output voltage should be $1.0V \pm 0.5\%$ typical.
- Use a fan (for example: AC Axial Fan, Model: AA1281LS-AT, ADDA CORP. AC 110–120V 50/60Hz) to provide direct forced airflow to the demo board. Turn on the fan and place the fan about 5 inches from the demo board under test. This fan can temporarily be used for quick evaluation of the demo board at 300A to 400A load current but proper forced airflow system that can provide at least 400LFM or higher to the board under test, is strongly recommended for prolong operation of the demo board at maximum load current of 480A or 500A.
- Once the input and output voltage are properly established and the fan is turned on, adjust the load current within the operating range of 0A to 480A max. Observe the output voltage regulation, output voltage ripples, switching node waveform, load transient response and other parameters. Refer to Figure 2 for proper output voltage ripples measurement.

NOTE: To measure the input/output voltage ripples properly, do not use the long ground lead on the oscilloscope probe. See Figure 2 for the proper scope probe technique. Short, stiff leads need to be soldered to the (+) and (-) terminals of an input or output capacitor. The probe’s ground ring needs to touch the (-) lead and the probe tip needs to touch the (+) lead.

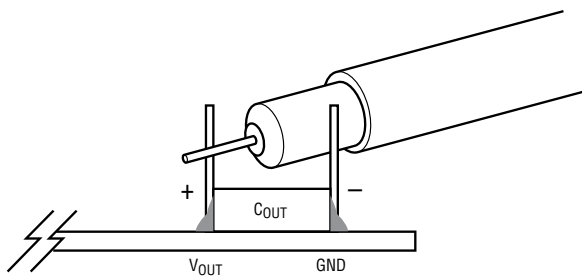

Figure 2. Scope Probe Placement for Measuring Output Ripple Voltage

The output voltage ripples can also be monitored using onboard V_{OUT} BNC terminal. Connect a short BNC cable from V_{OUT} (J11) to the input channel of the oscilloscope (scope probe ratio 1:1, AC-coupling) to observe output voltage ripples.

- (Option) Operation with V_{BIAS}
 V_{BIAS} pin is the 5.5V output of an internal buck regulator that can be enabled or disabled with RUNP. V_{BIAS} regulator input is V_{IN_VBIAS} pin and powered from V_{IN} . The advantage of using V_{BIAS} is bypassing the internal INTVCC_LDO powered from V_{IN} , turning on the internal switch connected the 5.5V V_{BIAS} to INTVCC_01 and INTVCC_23 of the part, therefore reducing the power loss, improving the overall efficiency and lowering the temperature rise of the part while operating at high V_{IN} and high switching frequency. V_{BIAS} must exceed 4.8V and V_{IN} must be greater than 7V to activate the internal switch connecting V_{BIAS} to INTVCC_01 and INTVCC_23 of the part. In typical applications, it is recommended to enable V_{BIAS} .
- Operation at low V_{IN} : $4.5V \leq V_{IN} \leq 5.75V$
Set RUNP (JP1) to the “OFF” position. Remove R1, R47, R83, R119 to disconnect V_{IN_VBIAS} from V_{IN} . Short V_{BIAS} to GND by stuffing R8, R54, R90, R126 with zero-ohm resistors. Tie SV_{IN} to INTVCC by stuffing R157, R158, R159, R160, R161, R162, R163 and R164 with zero-ohm resistors. Make sure V_{IN} is within $4.5V \leq V_{IN} \leq 5.75V$. Additional input electrolytic capacitors should be installed between V_{IN} (J1) and GND (J2) to prevent V_{IN} from drooping or overshoot to a voltage level that can exceed the specified minimum V_{IN} (4.5V) and maximum V_{IN} (5.75V) during large output load transient. Since SV_{IN} is tied to V_{IN} and INTVCC is tied to SV_{IN} , monitor SV_{IN} and INTVCC to make sure INTVCC abs max voltage (6V) should never be exceeded to avoid permanent damage to the regulator.

QUICK START PROCEDURE

10. (Option) Onboard Load Step Circuit

DC3082A-C provides onboard load transient circuit to measure ΔV_{OUT} peak-to-peak deviation during rising or falling dynamic load transient. The simple load step circuit consisting of three paralleled 30V N-channel power MOSFETs in series with three paralleled $3m\Omega$, 1W, 1% current sense resistors. The MOSFETs are configured as voltage control current source (VCCS) devices, therefore the output current step and its magnitude is created and controlled by adjusting the amplitude of the applied input voltage step at the gate of the MOSFETs. Use a function generator to provide a voltage pulse between IOSTEP_CLK (E33) and GND (E34). The input voltage pulse should be set at pulse width less than $300\mu s$ and maximum duty cycle less than 2% to avoid excessive thermal stress on the MOSFET devices. The output current step is measured directly across the current sense resistors and monitored by connecting

BNC cable from IOSTEP (J13) to the input of the oscilloscope (scope probe ratio 1:1, DC-coupling). The equivalent voltage to current scale is $1mV/1A$. The load step current slew rate di/dt can be varied by adjusting the rise time and fall time of the input voltage pulse applied at the gate of the MOSFETs. Output ripple voltage and output voltage during load transient of DC3082A-C should be measured at V_{OUT} BNC (J11) using short BNC cable. DC output voltage of DC3082A-C should be measured between V_{OSNS}^+ (E3) and V_{OSNS}^- (E4) test points.

Refer to Figure 3 for proper demo board set up with PC. Users can use a PC to reconfigure the power management features of the LTM4681 such as: nominal V_{OUT} , margin set points, OV/UV limits, output current and temperature fault limits, sequencing parameters, the fault logs, fault responses, GPIOs and other functionality. The DC1613A dongle can be hot plugged when V_{IN} is present.

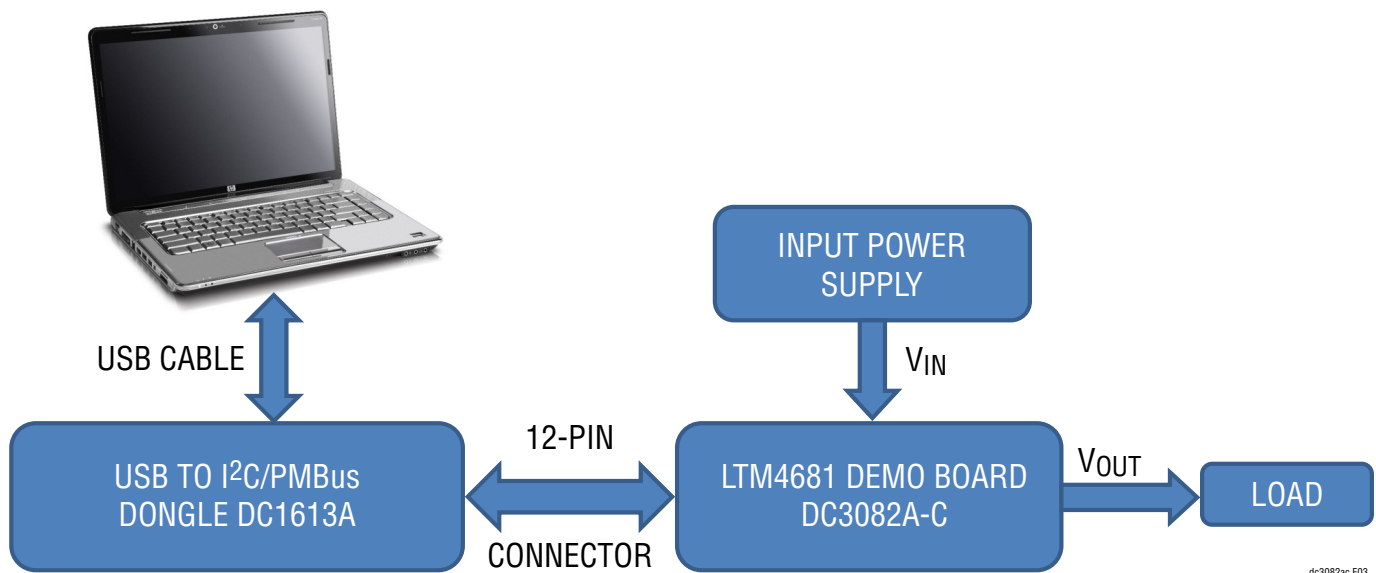

Figure 3. DC3082A-C Demo Board Setup with PC

dc3082ac F03

LTpowerPlay QUICK START GUIDE

LTpowerPlay is a powerful Windows-based development environment that supports ADI power system management ICs. The software supports a variety of different tasks. You can use LTpowerPlay to evaluate ADI PSM μ Module by connecting to a demo board system. LTpowerPlay can also be used in an off-line mode (with no hardware present) to build a multichip configuration file that can be saved and reloaded anytime. LTpowerPlay provides unprecedented diagnostic tool and debug features. It becomes a valuable diagnostic tool during board bring-up to program or tweak the power management scheme in a system, or to diagnose power issues when bringing up rails. LTpowerPlay utilizes the DC1613A USB-to-PMBus controller to communicate with one of many

potential targets, including all the parts in ADI PSM product category demo system. The software also provides an automatic update feature to keep the software current with the latest set of device drivers and documentation.

USB to PMBus Controller Dongle DC1613A for use with LTpowerPlay is available at [DC1613A](#).

To access technical support documents for ADI Digital Management Products, visit Help or view on-line help on the LTpowerPlay GUI main menu. The following procedure describes how to use LTpowerPlay to monitor and change the settings of LTM4681.

1. Download and install the [LTpowerPlay GUI](#).

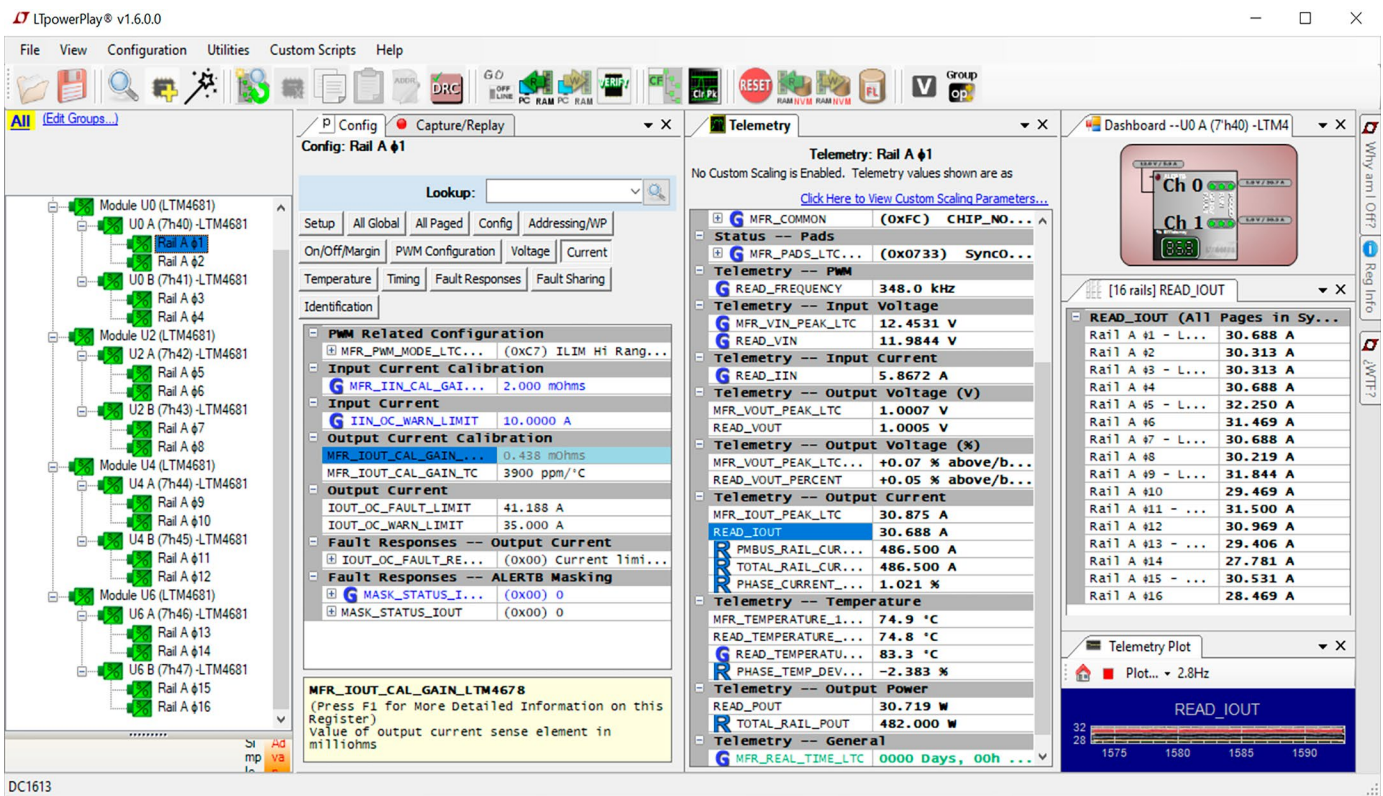
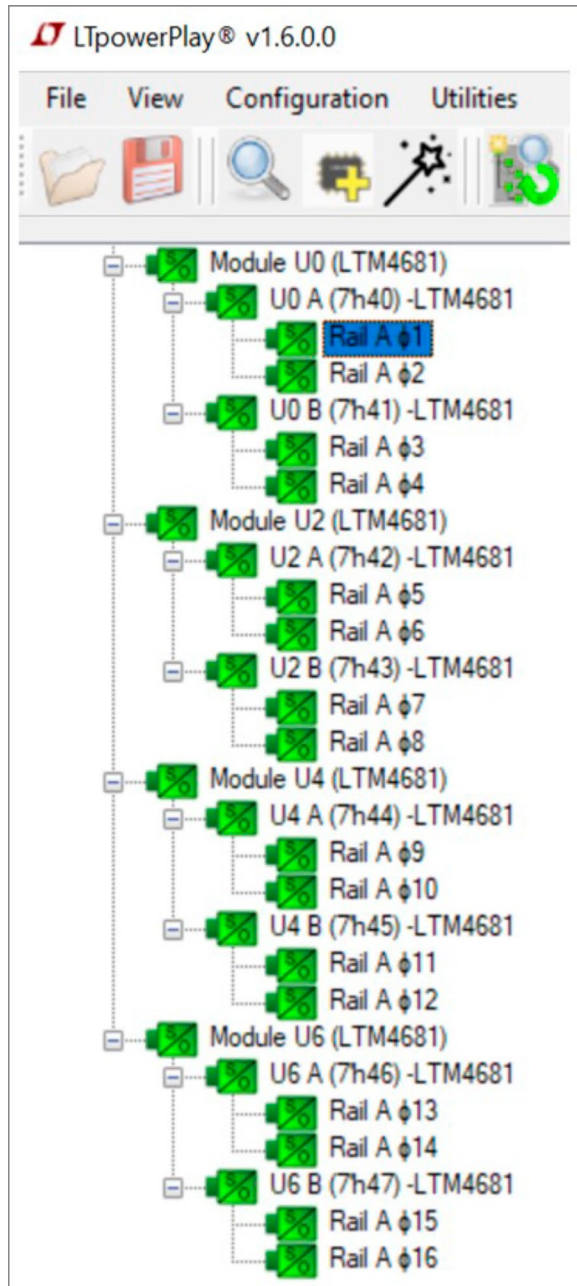

Figure 4. LTpowerPlay Main Interface

LTpowerPlay QUICK START GUIDE

2. Launch the LTpowerPlay GUI.
 - a. The GUI should automatically identify the DC3082A-C.

The system tree on the left-hand side should look like this for DC3082A-C:



- b. A green message box shows for a few seconds in the lower left-hand corner, confirming that LTM4681 is communicating:

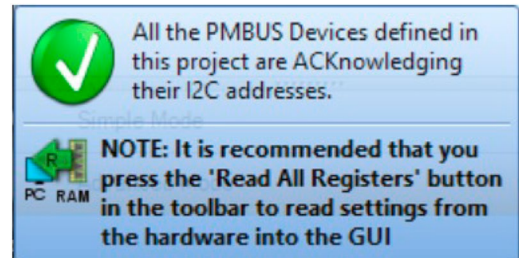

- c. In the Toolbar, click the “R” (RAM to PC) icon to read the RAM from the LTM4681. The configuration is read from the LTM4681 and loaded into the GUI:



- d. Example of program the output voltage to a different value.

In the Config Tab, click on the “Voltage” Tab in the main menu bar, type in 1.2V in the VOUT_COMMAND box as showed below:

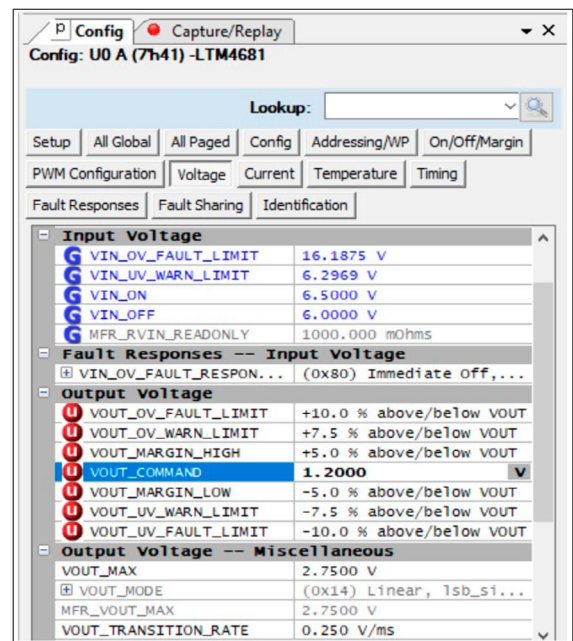

Then click the “W” (PC to RAM) icon to write these register values to the LTM4681.

LTpowerPlay QUICK START GUIDE



The output voltage will change to 1.2V.
If the write command is successfully executed, the following message should be seen:

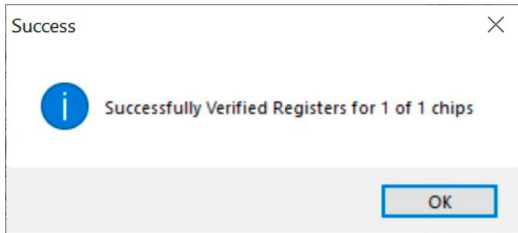

- f. Save the demo board configuration to a (*.proj) file. Click the Save icon and save the file with a preferred file name.



- e. All user configuration or changes can be saved into the NVM. In the toolbar, click “RAM to NVM” icon:

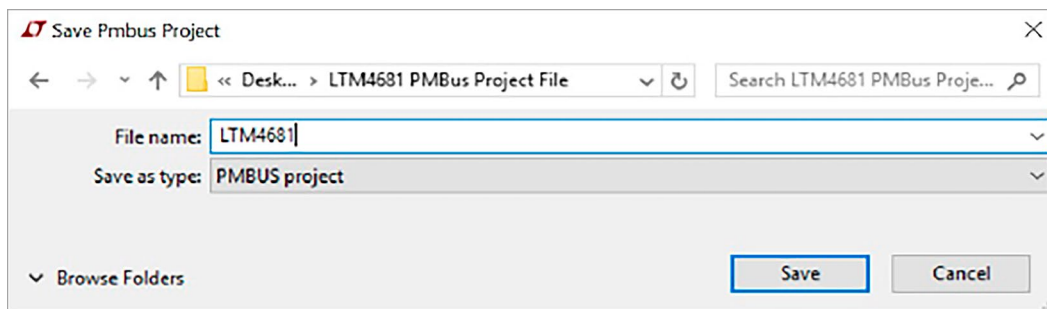

TEST RESULTS

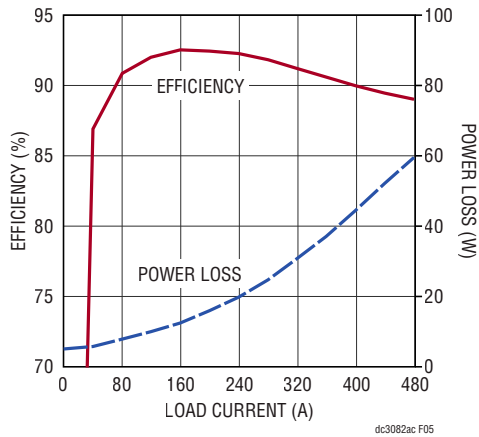

CIRCUIT CONFIGURATION: 16-PHASE SINGLE OUTPUT
 $f_{SW} = 350\text{kHz}$, $V_{IN} = 12\text{V}$, $V_{OUT} = 1\text{V}$
 $I_{LOAD} = 0\text{A TO } 480\text{A}$
 $V_{BIAS} = 5.5\text{V}$ (RUNP: ON)
 V_{IN} , V_{OUT} WAS MEASURED ACROSS C_{IN11} , C_{O15}
 FAST PULSE LOAD CURRENT USED TO MEASURE EFFICIENCY
 $T_A = 25^\circ\text{C}$, NO FORCED AIRFLOW, NO HEAT SINK

Figure 5. Efficiency: 1V_{OUT}

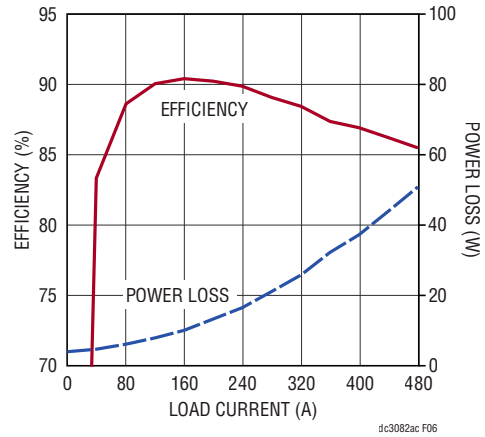

CIRCUIT CONFIGURATION: 16-PHASE SINGLE OUTPUT
 $f_{SW} = 250\text{kHz}$, $V_{IN} = 12\text{V}$, $V_{OUT} = 0.6\text{V}$
 $I_{LOAD} = 0\text{A TO } 480\text{A}$
 $V_{BIAS} = 5.5\text{V}$ (RUNP: ON)
 V_{IN} , V_{OUT} WAS MEASURED ACROSS C_{IN11} , C_{O15}
 FAST PULSE LOAD CURRENT USED TO MEASURE EFFICIENCY
 $T_A = 25^\circ\text{C}$, NO FORCED AIRFLOW, NO HEAT SINK

Figure 6. Efficiency: 0.6V_{OUT}

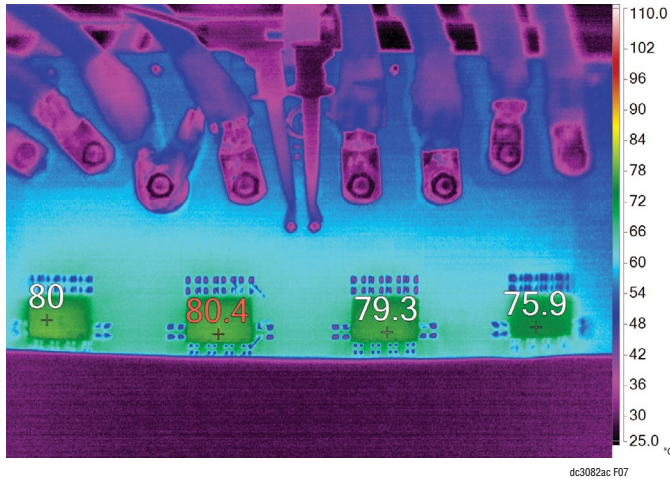

CIRCUIT CONFIGURATION: 16-PHASE SINGLE OUTPUT
 $f_{SW} = 350\text{kHz}$, $V_{IN} = 12\text{V}$, $V_{OUT} = 1\text{V}$
 $I_{LOAD} = 300\text{A}$
 $V_{BIAS} = 5.5\text{V}$ (RUNP: ON)
 $T_A = 25^\circ\text{C}$, NO FORCED AIRFLOW, NO HEAT SINK

Figure 7. Thermal Performance, No Airflow

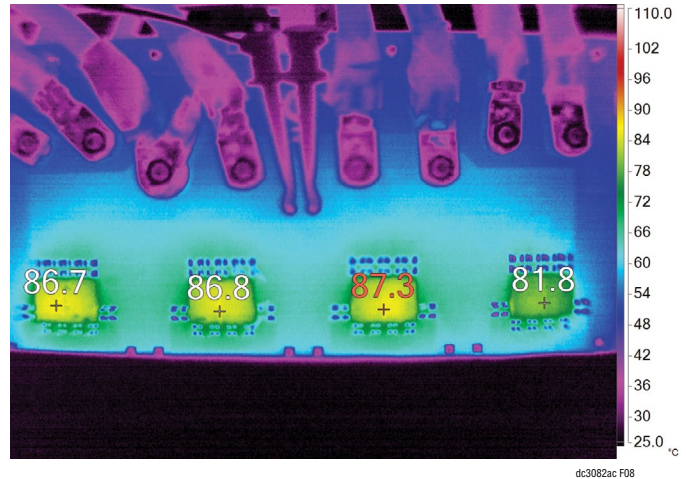

CIRCUIT CONFIGURATION: 16-PHASE SINGLE OUTPUT
 $f_{SW} = 350\text{kHz}$, $V_{IN} = 12\text{V}$, $V_{OUT} = 1\text{V}$
 $I_{LOAD} = 480\text{A}$
 $V_{BIAS} = 5.5\text{V}$ (RUNP: ON)
 $T_A = 25^\circ\text{C}$, FORCED AIRFLOW = 400LFM, NO HEAT SINK

Figure 8. Thermal Performance, 400LFM Forced Airflow

TEST RESULTS

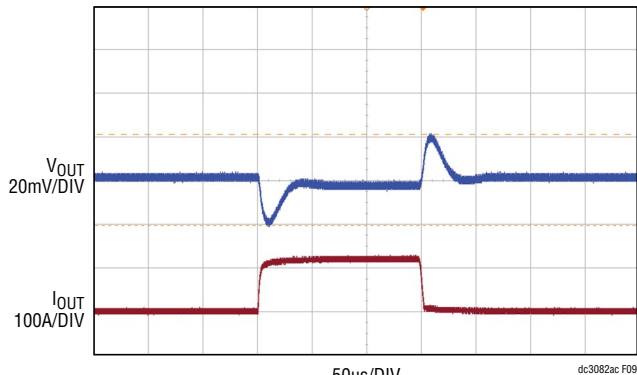

CIRCUIT CONFIGURATION: 16-PHASE SINGLE OUTPUT
 $f_{SW} = 350\text{kHz}$, $V_{IN} = 12\text{V}$, $V_{OUT} = 1\text{V}$
 $I_{LOAD-STEP} = 0\text{A TO } 120\text{A AT } d_{IL}/d_t = 40\text{A}/\mu\text{s}$
 $V_{OUT(P-P)} = 41.9\text{mV}$
 OUTPUT VOLTAGE MEASURED AT V_{OUT} BNC (J11)
 AC-COUPLING, 20MHz BWL

Figure 9. Load Transient Response

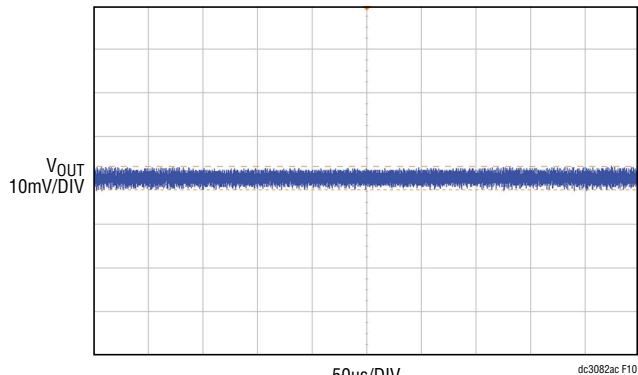

CIRCUIT CONFIGURATION: 16-PHASE SINGLE OUTPUT
 $f_{SW} = 350\text{kHz}$, $V_{IN} = 12\text{V}$, $V_{OUT} = 1\text{V}$
 $I_{LOAD} = 480\text{A}$
 $V_{OUT(P-P)} = 5.3\text{mV}$
 OUTPUT VOLTAGE MEASURED AT V_{OUT} BNC (J11)
 AC-COUPLING, 20MHz BWL

Figure 10. Output Ripple Voltage

PARTS LIST

ITEM	QTY	REFERENCE	PART DESCRIPTION	MANUFACTURER/PART NUMBER
DC3082A-C Required Circuit Components				
1	20	C1, C7, C8, C10, C11, C26, C32, C33, C35, C36, C50, C56, C57, C59, C60, C74, C80, C81, C83, C84	CAP, 1µF, X7R, 25V, 10%, 0603, AEC-Q200	MURATA, GCM188R71E105KA64D
2	8	C2, C3, C27, C28, C51, C52, C75, C76	CAP, 2.2µF, X5R, 25V, 10%, 0603	MURATA, GRM188R61E225KA12D
3	8	C6, C9, C31, C34, C55, C58, C79, C82	CAP, 4.7µF, X5R, 16V, 10%, 0603	MURATA, GRM188R61C475KAAJD
4	4	C12, C37, C61, C85	CAP, 22µF, X5R, 16V, 10%, 1206	AVX, 1206YD226KAT2A
5	1	C14	CAP, 0.015µF, X7R, 50V, 5%, 0603	AVX, 06035C153JAT2A
6	1	C15	CAP, 470pF, X7R, 50V, 10%, 0603	AVX, 06035C471KAT2A
7	15	C18, C21, C24, C39, C42, C45, C48, C63, C66, C69, C72, C87, C91, C94, C97	CAP, 10pF, C0G, 50V, 5%, 0603	AVX, 06035A100JAT2A
8	1	C99	CAP, 0.01µF, X7R, 50V, 10%, 0603	AVX, 06035C103KAT2A
9	2	C100, C101	CAP, 100µF, X5R, 6.3V, 10%, 1206	MURATA, GRM31CR60J107KE39L
10	2	C102, C103	CAP, 0.1µF, X7R, 16V, 10%, 0603, FLEXITERM	AVX, 0603YC104KAZ2A
11	4	CIN1-CIN4	CAP, 270µF, ALUM POLY HYB, 25V, 20%, 8mm × 10.2mm SMD, RADIAL, AEC-Q200, EEHZK	PANASONIC, EEH-ZK1E271P
12	34	CIN5-CIN38	CAP, 22µF, X5R, 25V, 10%, 1210	KEMET, C1210C226K3PACTU
13	66	C01-C04, C08-C011, C015-C018, C022-C025, C029-C032, C036-C039, C043-C046, C050-C053, C057-C060, C064-C067, C071-C074, C078-C081, C085-C088, C092-C095, C099-C0102, C0106-C0109, C0113, C0114	CAP, 100µF, X5R, 6.3V, 20%, 1210	AVX, 12106D107MAT2A

PARTS LIST

ITEM	QTY	REFERENCE	PART DESCRIPTION	MANUFACTURER/PART NUMBER
14	48	C05-C07, C012-C014, C019-C021, C026-C028, C033-C035, C040-C042, C047-C049, C054-C056, C061-C063, C068-C070, C075-C077, C082-C084, C089-C091, C096-C098, C0103-C0105, C0110-C0112	CAP., 470 μ F, TANT, POSCAP, 2.5V, 20%, 7343, TPF SERIES	PANASONIC, ETPF470M5H
15	1	D1	LED, GREEN, WATER CLEAR, 0603	WURTH ELEKTRONIK, 150060GS75000
16	2	D2, D3	LED, RED, WATER CLEAR, 0603	WURTH ELEKTRONIK, 150060RS75000
17	2	D4, D5	DIODE, SCHOTTKY, 20V, 0.5A, SOD-882, LEADLESS	NEXPERIA, PMEG2005AEL, 315
18	1	Q3	XSTR., MOSFET, N-CH, 60V, 220mA, SOT23-3, AEC-Q101	DIODES INC., 2N7002A-13
19	2	Q7, Q9	XSTR., MOSFET, P-CH, 20V, 5.9A, SOT-23-3 (TO-236-3)	VISHAY, Si2365EDS-T1-GE3
20	3	Q13, Q14, Q17	XSTR., MOSFET, N-CH, 30V, 150A, D2PAK	INFINEON, IRL7833STRLPBF
21	12	R1-R3, R47-R49, R83-R85, R119-R121	RES., 1 Ω , 1%, 1/10W, 0603, AEC-Q200	NIC, NRC06F1R00TRF
22	8	R1A, R1B, R1C, R1D, R2A, R2B, R2C, R2D	RES., 0.002 Ω , 1%, 1W, 2512, SENSE	VISHAY, WSL25122L000FEA
23	18	R4-R7, R9, R23, R50-R53, R86-R89, R122-R125	RES., 0 Ω , 1/10W, 0603, AEC-Q200	VISHAY, CRCW06030000Z0EA
24	3	R11, R12, R156	RES., 10 Ω , 1%, 1/10W, 0603	VISHAY, CRCW060310R0FKEA
25	6	R15, R20-R22, R155, R180	RES., 10k, 1%, 1/10W, 0603, AEC-Q200	VISHAY, CRCW060310K0FKEA
26	2	R16, R17	RES., 1k, 1%, 1/10W, 0603	VISHAY, CRCW06031K00FKEA
27	4	R18, R19, R186, R187	RES., 4.99k, 1%, 1/10W, 0603, AEC-Q200	PANASONIC, ERJ3EKF4991V
28	1	R36	RES., 787 Ω , 1%, 1/10W, 0603	NIC, NRC06F7870TRF
29	1	R58	RES., 1.65k, 1%, 1/10W, 0603	NIC, NRC06F1651TRF
30	1	R72	RES., 2.43k, 1%, 1/10W, 0603	YAGEO, 9C06031A2431FKHFT
31	1	R94	RES., 3.24k, 1%, 1/10W, 0603	YAGEO, RC0603FR-073K24L
32	1	R108	RES., 4.22k, 1%, 1/10W, 0603	NIC, NRC06F4221TRF
33	1	R130	RES., 5.23k, 1%, 1/10W, 0603, AEC-Q200	PANASONIC, ERJ3EKF5231V
34	1	R144	RES., 6.34k, 1%, 1/10W, 0603, AEC-Q200	KOA SPEER, RK73H1JTTD6341F
35	1	R177	RES., 200 Ω , 1%, 1/10W, 0603	VISHAY, CRCW0603200RFKEA
36	2	R178, R179	RES., 127 Ω , 1%, 1/10W, 0603, AEC-Q200	NIC, NRC06F1270TRF
37	3	R181-R183	RES., 0.003 Ω , 1%, 1W, 2512, \pm 350ppm, METAL, SENSE	PANASONIC, ERJM1WSF3M0U
38	2	R184, R185	RES., 0 Ω , 1W, 2512, SENSE, COPPER	VISHAY, WSL251200000ZEA9
39	1	SW1	SWITCH, SLIDE, DPDT, 0.3A, 6VDC, PTH	C&K, JS202011CQN
40	4	U1-U4	IC, QUAD OUTPUT μ Module REG., BGA	ANALOG DEVICES, LTM4681IY#PBF
41	1	U5	IC, MEMORY, EEPROM, 2Kb (256x8), TSSOP-8, 400kHz	MICROCHIP, 24LC025-I/ST

DEMO MANUAL

DC3082A-C

PARTS LIST

ITEM	QTY	REFERENCE	PART DESCRIPTION	MANUFACTURER/PART NUMBER
DC3082A-C Additional Demo Board Circuit Components				
1	0	C4, C5, C13, C17, C20, C23, C29, C30, C38, C41, C44, C47, C53, C54, C62, C65, C68, C71, C77, C78, C86, C89, C93, C96	CAP., OPTION, 0603	
2	0	C16, C19, C22, C25, C40, C43, C46, C49, C64, C67, C70, C73, C88, C92, C95, C98	CAP., OPTION, 0805	
3	0	Q1	XSTR., OPTION, MOSFET, P-CH, SOT-23	
4	0	R8, R10, R24-R32, R34, R35, R37-R46, R54, R57, R59-R68, R71, R73-R82, R90, R93, R95-R104, R107, R109-R118, R126, R129, R131-R140, R143, R145-R154, R157-R174, R189	RES., OPTION, 0603	
5	0	R13, R14, R33, R55, R56, R69, R70, R91, R92, R105, R106, R127, R128, R141, R142, R188	RES., OPTION, 0805	
6	0	R175, R176	RES., OPTION, 2512	
DC3082A-C Hardware: For DC3082A-C Only				
1	34	E1-E34	TEST POINT, TURRET, 0.094 MTG. HOLE, PCB 0.062 THK	MILL-MAX, 2501-2-00-80-00-00-07-0
2	12	J1--J10, J29, J30	EVAL BOARD STUD HARDWARE SET, #10-32	ANALOG DEVICES, 720-0010
3	2	J11, J13	CONN., RF, BNC, RCPT, JACK, 5-PIN, ST, THT, 50Ω	AMPHENOL RF, 112404
4	1	J27	CONN., HDR, SHROUDED, MALE, 1×4, 2mm, VERT, ST, THT	HIROSE ELECTRIC, DF3A-4P-2DSA
5	1	J28	CONN., HDR, SHROUDED, MALE, 2×6, 2mm, VERT, ST, THT	AMPHENOL, 98414-G06-12ULF
6	2	JP1, JP2	CONN., HDR, MALE, 1×3, 2mm, VERT, ST, THT, NO SUBS. ALLOWED	WURTH ELEKTRONIK, 62000311121
7	1	LB1	LABEL SPEC, DEMO BOARD SERIAL NUMBER	BRADY, THT-96-717-10
8	4	MP1-MP4	STANDOFF, NYLON, SNAP-ON, 0.5" (12.7mm)	WURTH ELEKTRONIK, 702935000
9	1	PCB1	PCB, DC3082A	ANALOG DEVICES APPROVED SUPPLIER, 600-DC3082A
10	1	STNCL1	TOOL, STENCIL, DC3082A	ANALOG DEVICES APPROVED SUPPLIER, 830-DC3082A
11	2	XJP1, XJP4	CONN., SHUNT, FEMALE, 2 POS, 2mm	WURTH ELEKTRONIK, 60800213421

SCHEMATIC DIAGRAM

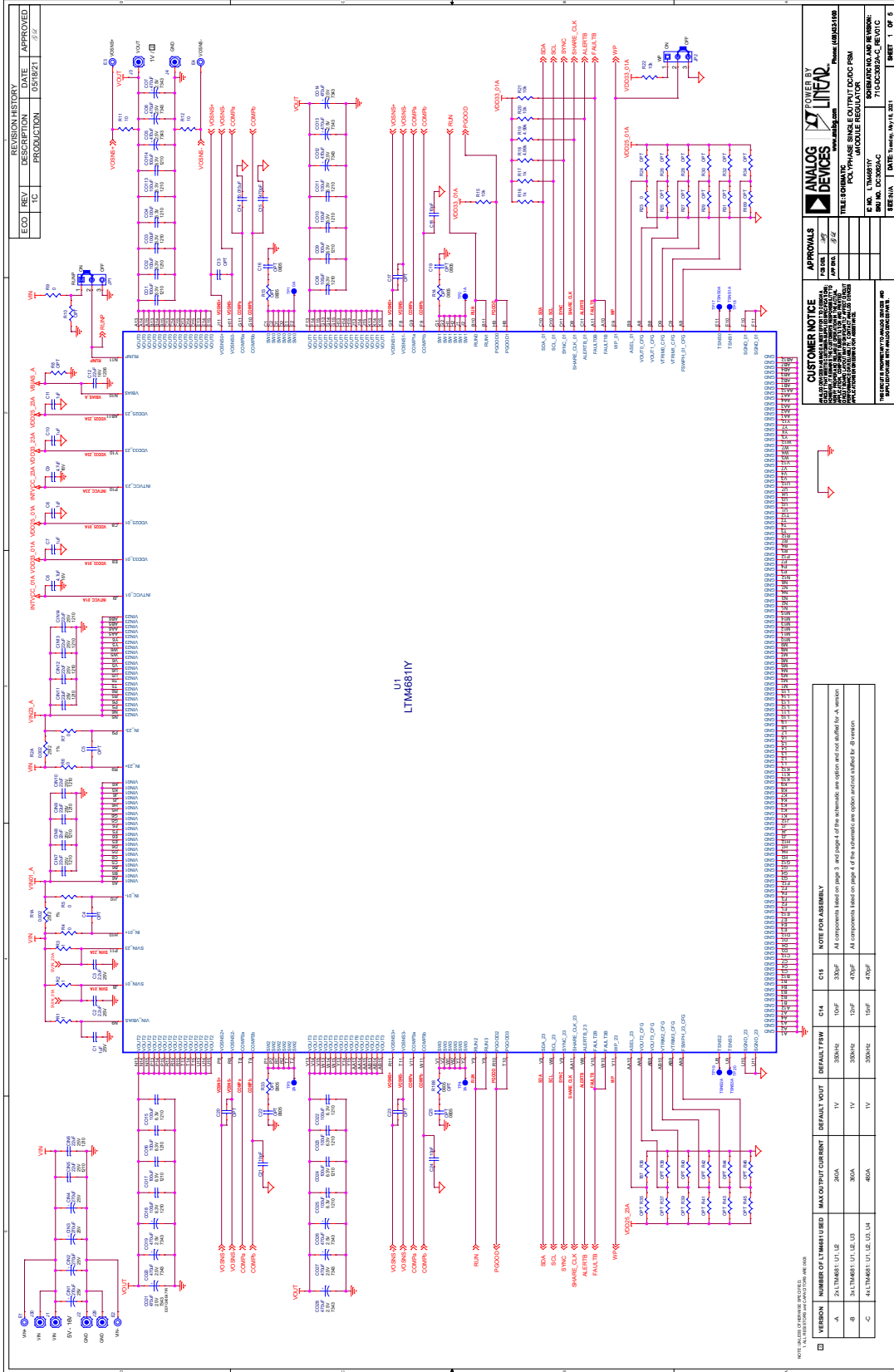

DEMO MANUAL

DC3082A-C

SCHEMATIC DIAGRAM

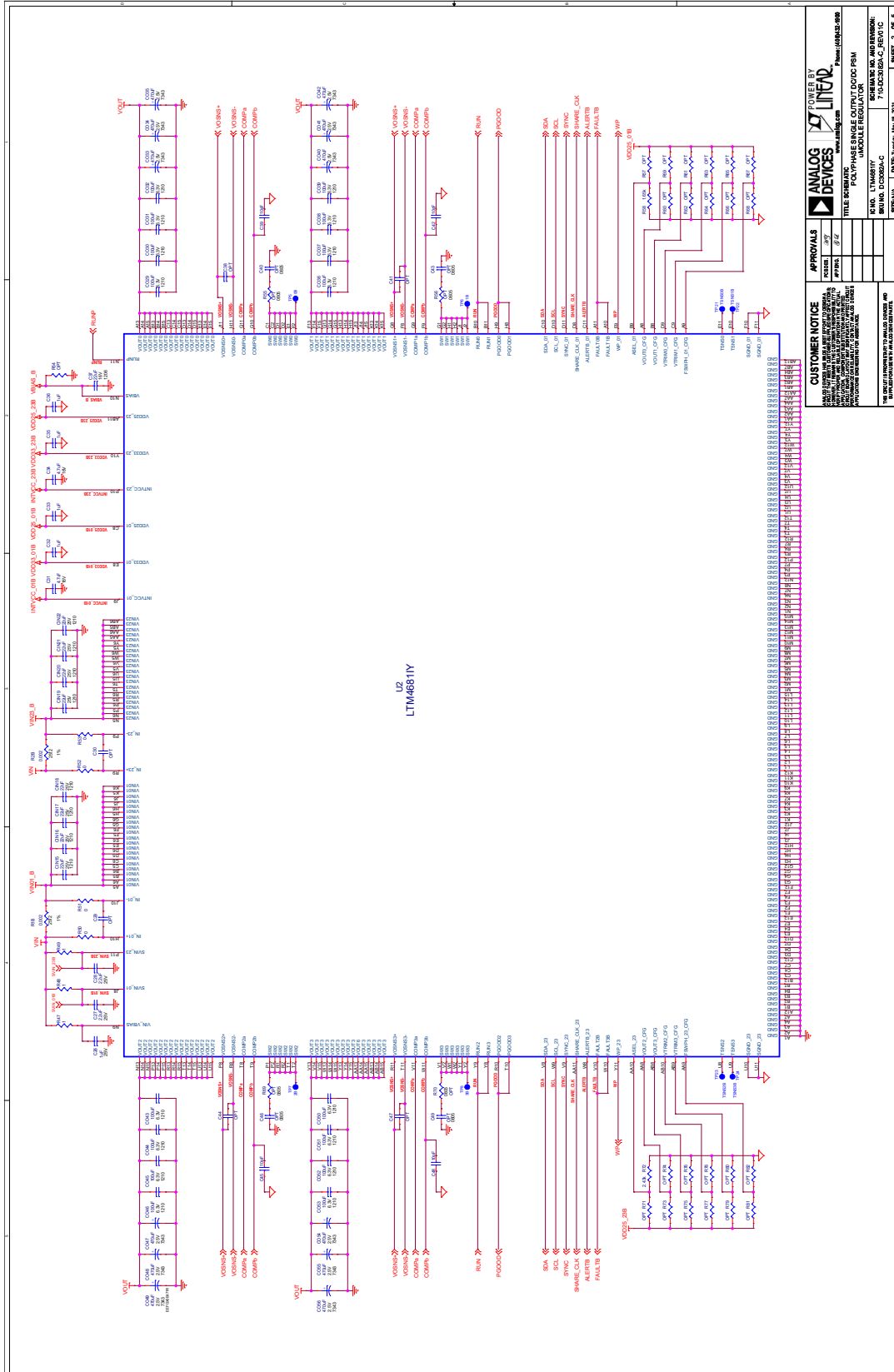

SCHEMATIC DIAGRAM

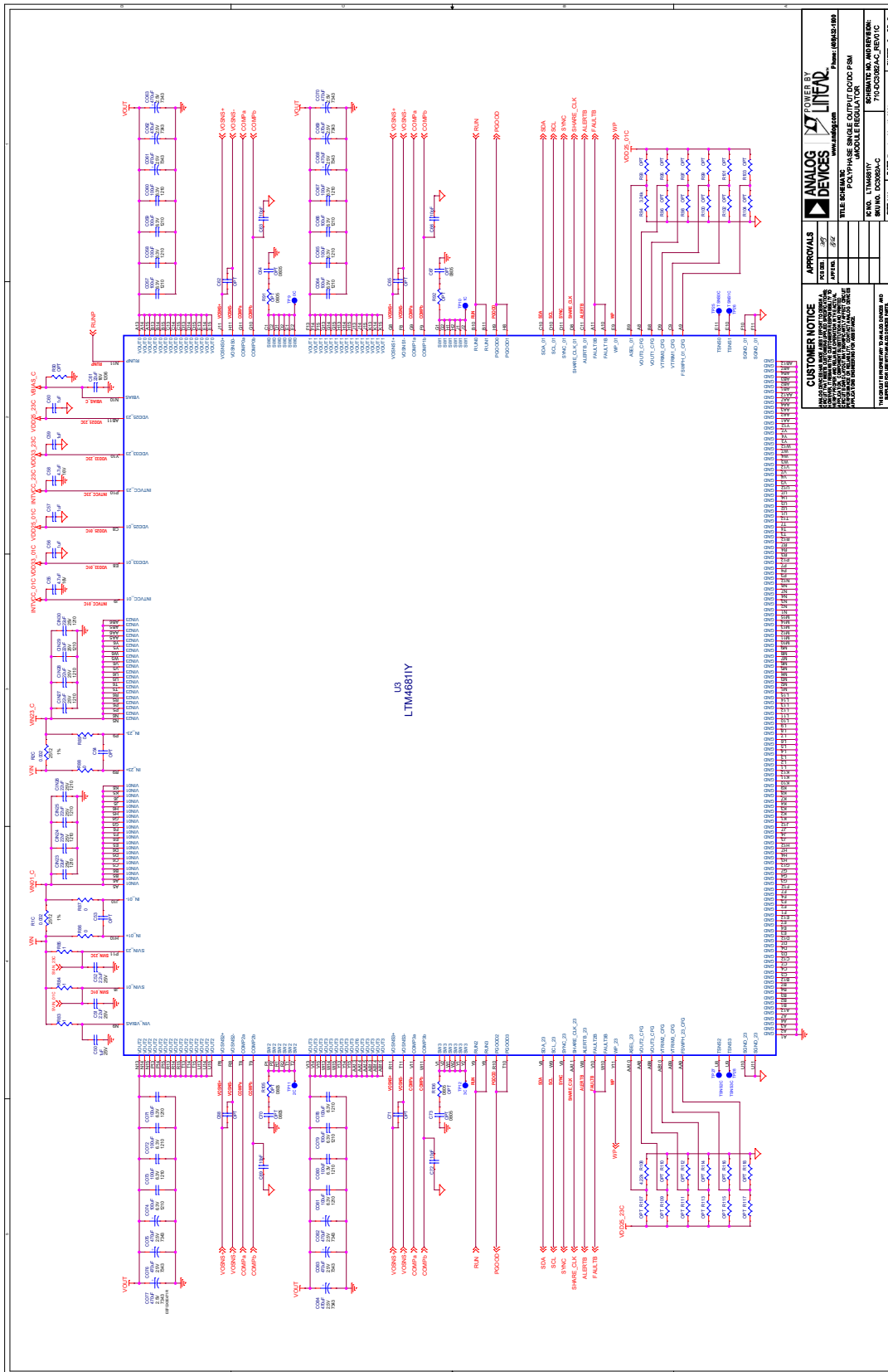

POWER BY
ANALOG DEVICES **LINER**
www.analog.com

TITLE MULTIPHASE SINGLE OUTPUT DCDC PSM
REV. NO. 02/0201
MODULE REGULATOR
DATE 2/2/01
SHA. NO. 020201AC
REV. I.C. 71020201AC REV I C

APPROVALS	
DESIGNER	
DESIGN CHECK	

CUSTOMER NOTICE:
THIS DOCUMENT IS THE PROPERTY OF ANALOG DEVICES. IT IS TO BE USED FOR THE DESIGN AND CONSTRUCTION OF CUSTOMER EQUIPMENT ONLY. IT IS TO BE KEPT CONFIDENTIAL AND NOT TO BE REPRODUCED OR TRANSMITTED IN ANY FORM OR BY ANY MEANS, ELECTRONIC OR MECHANICAL, INCLUDING PHOTOCOPYING, RECORDING, OR BY ANY INFORMATION STORAGE AND RETRIEVAL SYSTEM. ANALOG DEVICES ACCEPTS NO LIABILITY FOR ANY ERRORS OR OMISSIONS. THIS DOCUMENT IS SUBJECT TO CHANGE WITHOUT NOTICE.

© ANALOG DEVICES INC. 2001. ALL RIGHTS RESERVED.
LTM4881Y IS A REGISTERED TRADEMARK OF ANALOG DEVICES.
THIS DOCUMENT IS THE PROPERTY OF ANALOG DEVICES.

SHEET 3 OF 5

DEMO MANUAL DC3082A-C

SCHEMATIC DIAGRAM

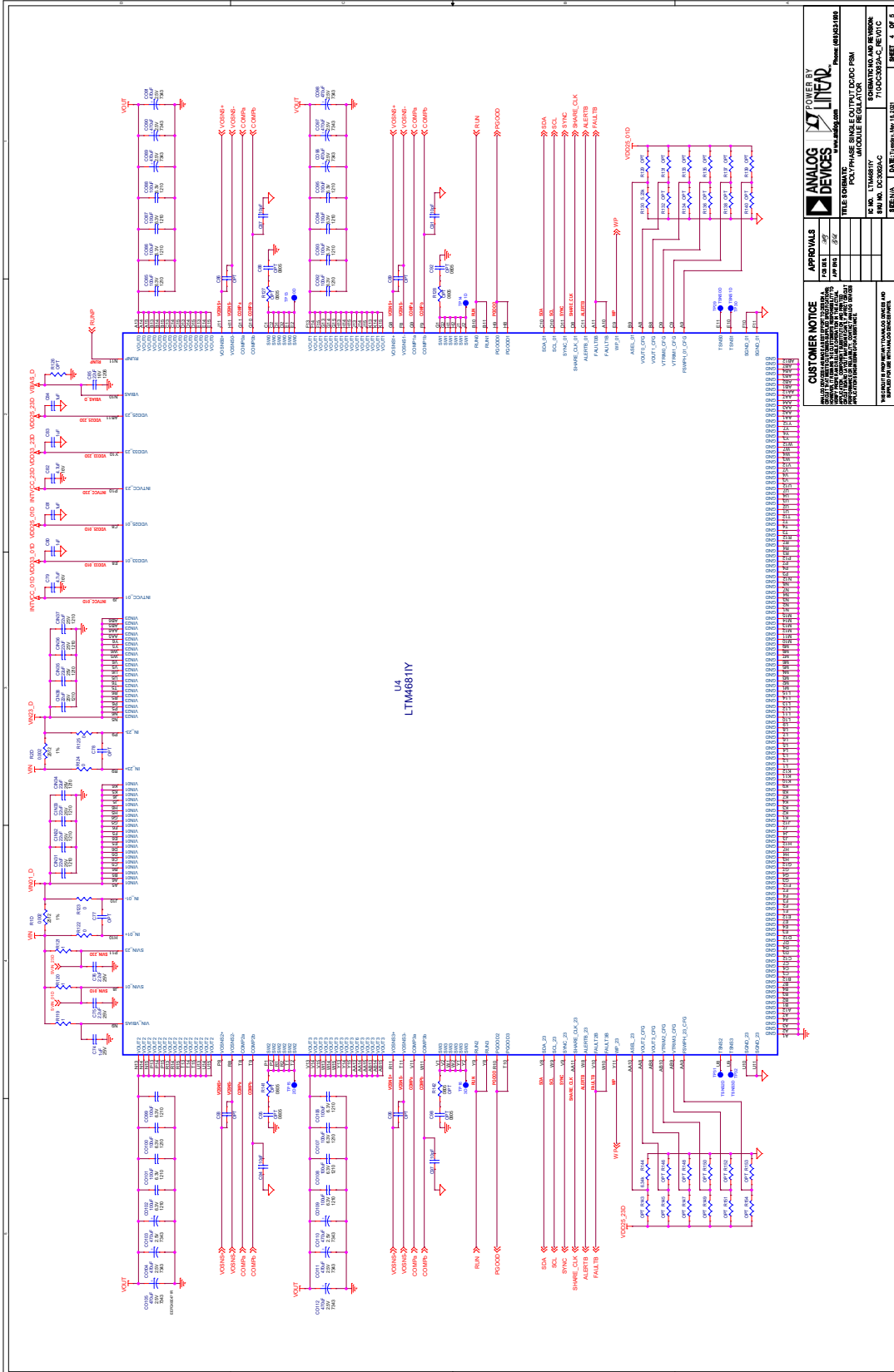

CUSTOMER NOTICE
 THIS PRODUCT IS PROVIDED AS A DEMO BOARD AND IS NOT INTENDED FOR PRODUCTION USE. THE BOARD IS PROVIDED AS-IS AND WITHOUT WARRANTY OF ANY KIND, INCLUDING MERCHANTABILITY AND FITNESS FOR A PARTICULAR PURPOSE. THE BOARD IS PROVIDED AS A SERVICE TO OUR CUSTOMERS AND IS NOT A PRODUCT OF ANALOG DEVICES.

APPROVALS
 DATE: 01/11/11
 BY: [Signature]
 TITLE: PRODUCT MANAGER
 PRODUCT: LTM481Y
 BOARD: DC3082A-C
 REVISION: 1.0

POWER BY LINEAR
 ANALOG DEVICES
 100 TOWER STREET
 NORFOLK, MA 01960
 TEL: 508.548.7000
 FAX: 508.548.1000
 WWW.ANALOGDEVICES.COM

FORMATTED AND REVISIONED BY: [Signature]
 DATE: 01/11/11
 REVISION: 1.0
 SHEET 7 OF 8

SCHEMATIC DIAGRAM

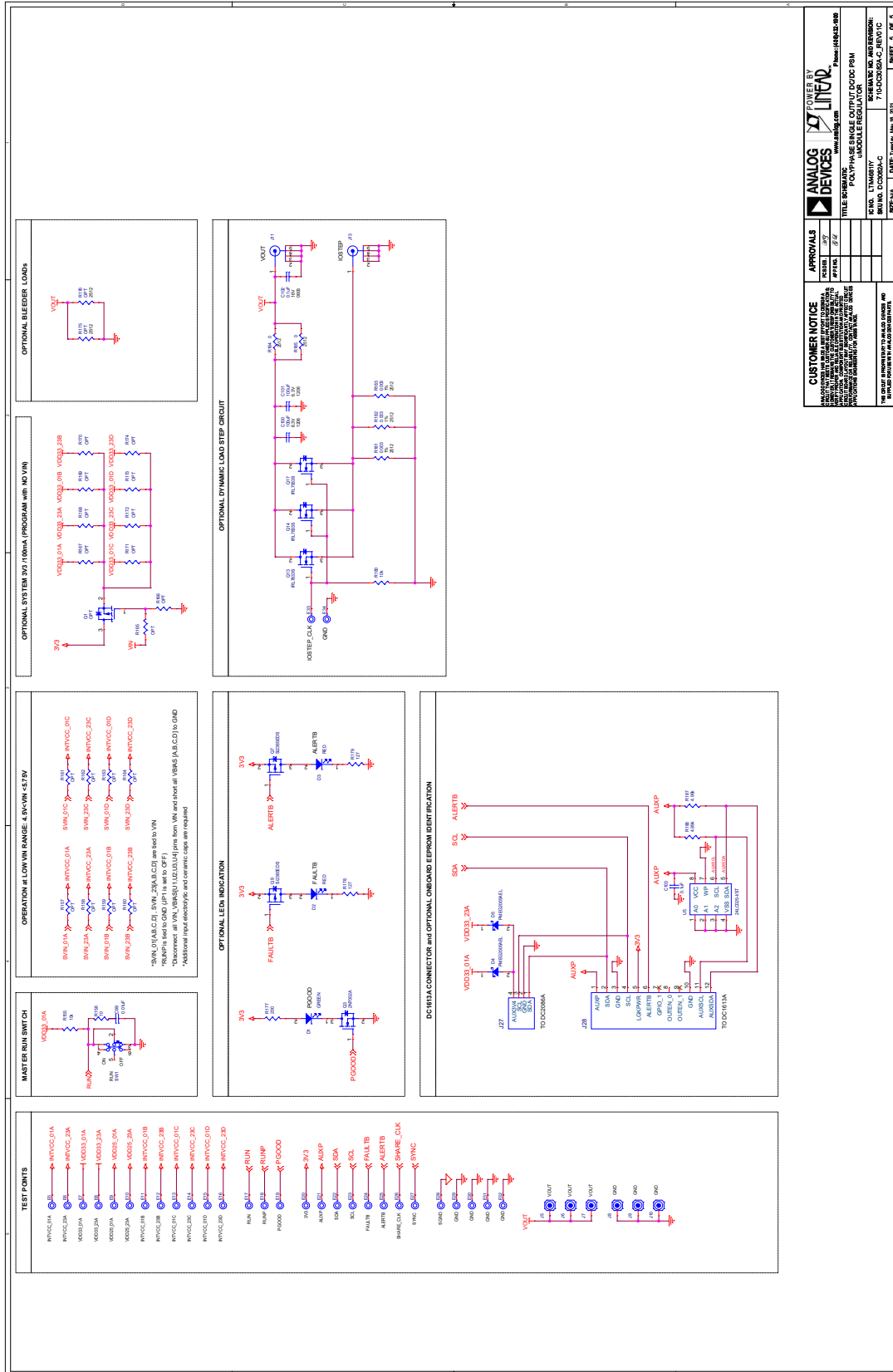

CUSTOMER NOTICE THIS DOCUMENT IS UNCLASSIFIED. IT IS THE PROPERTY OF ANALOG DEVICES AND IS LOANED TO YOUR ORGANIZATION. IT IS NOT TO BE REPRODUCED OR TRANSMITTED IN ANY FORM OR BY ANY MEANS, ELECTRONIC OR MECHANICAL, INCLUDING PHOTOCOPYING, RECORDING, OR BY ANY INFORMATION STORAGE AND RETRIEVAL SYSTEM.	
APPROVALS DESIGN: [] CHECKED: [] DATE: []	POWER BY ANALOG DEVICES LINEAD www.analog.com PART NUMBER: DC3082A-C TITLE: DEMO BOARD FOR PHASE SINGLE OUTPUT DCDC PFM UNICAP REGULATOR
REV. 0 17 OF 17	REV. 0 17 OF 17



ESD Caution

ESD (electrostatic discharge) sensitive device. Charged devices and circuit boards can discharge without detection. Although this product features patented or proprietary protection circuitry, damage may occur on devices subjected to high energy ESD. Therefore, proper ESD precautions should be taken to avoid performance degradation or loss of functionality.

Legal Terms and Conditions

By using the evaluation board discussed herein (together with any tools, components documentation or support materials, the "Evaluation Board"), you are agreeing to be bound by the terms and conditions set forth below ("Agreement") unless you have purchased the Evaluation Board, in which case the Analog Devices Standard Terms and Conditions of Sale shall govern. Do not use the Evaluation Board until you have read and agreed to the Agreement. Your use of the Evaluation Board shall signify your acceptance of the Agreement. This Agreement is made by and between you ("Customer") and Analog Devices, Inc. ("ADI"), with its principal place of business at One Technology Way, Norwood, MA 02062, USA. Subject to the terms and conditions of the Agreement, ADI hereby grants to Customer a free, limited, personal, temporary, non-exclusive, non-sublicensable, non-transferable license to use the Evaluation Board FOR EVALUATION PURPOSES ONLY. Customer understands and agrees that the Evaluation Board is provided for the sole and exclusive purpose referenced above, and agrees not to use the Evaluation Board for any other purpose. Furthermore, the license granted is expressly made subject to the following additional limitations: Customer shall not (i) rent, lease, display, sell, transfer, assign, sublicense, or distribute the Evaluation Board; and (ii) permit any Third Party to access the Evaluation Board. As used herein, the term "Third Party" includes any entity other than ADI, Customer, their employees, affiliates and in-house consultants. The Evaluation Board is NOT sold to Customer; all rights not expressly granted herein, including ownership of the Evaluation Board, are reserved by ADI. CONFIDENTIALITY. This Agreement and the Evaluation Board shall all be considered the confidential and proprietary information of ADI. Customer may not disclose or transfer any portion of the Evaluation Board to any other party for any reason. Upon discontinuation of use of the Evaluation Board or termination of this Agreement, Customer agrees to promptly return the Evaluation Board to ADI. ADDITIONAL RESTRICTIONS. Customer may not disassemble, decompile or reverse engineer chips on the Evaluation Board. Customer shall inform ADI of any occurred damages or any modifications or alterations it makes to the Evaluation Board, including but not limited to soldering or any other activity that affects the material content of the Evaluation Board. Modifications to the Evaluation Board must comply with applicable law, including but not limited to the RoHS Directive. TERMINATION. ADI may terminate this Agreement at any time upon giving written notice to Customer. Customer agrees to return to ADI the Evaluation Board at that time. LIMITATION OF LIABILITY. THE EVALUATION BOARD PROVIDED HEREUNDER IS PROVIDED "AS IS" AND ADI MAKES NO WARRANTIES OR REPRESENTATIONS OF ANY KIND WITH RESPECT TO IT. ADI SPECIFICALLY DISCLAIMS ANY REPRESENTATIONS, ENDORSEMENTS, GUARANTEES, OR WARRANTIES, EXPRESS OR IMPLIED, RELATED TO THE EVALUATION BOARD INCLUDING, BUT NOT LIMITED TO, THE IMPLIED WARRANTY OF MERCHANTABILITY, TITLE, FITNESS FOR A PARTICULAR PURPOSE OR NON-INFRINGEMENT OF INTELLECTUAL PROPERTY RIGHTS. IN NO EVENT WILL ADI AND ITS LICENSORS BE LIABLE FOR ANY INCIDENTAL, SPECIAL, INDIRECT, OR CONSEQUENTIAL DAMAGES RESULTING FROM CUSTOMER'S POSSESSION OR USE OF THE EVALUATION BOARD, INCLUDING BUT NOT LIMITED TO LOST PROFITS, DELAY COSTS, LABOR COSTS OR LOSS OF GOODWILL. ADI'S TOTAL LIABILITY FROM ANY AND ALL CAUSES SHALL BE LIMITED TO THE AMOUNT OF ONE HUNDRED US DOLLARS (\$100.00). EXPORT. Customer agrees that it will not directly or indirectly export the Evaluation Board to another country, and that it will comply with all applicable United States federal laws and regulations relating to exports. GOVERNING LAW. This Agreement shall be governed by and construed in accordance with the substantive laws of the Commonwealth of Massachusetts (excluding conflict of law rules). Any legal action regarding this Agreement will be heard in the state or federal courts having jurisdiction in Suffolk County, Massachusetts, and Customer hereby submits to the personal jurisdiction and venue of such courts. The United Nations Convention on Contracts for the International Sale of Goods shall not apply to this Agreement and is expressly disclaimed.