

LQG15WZ33NH02#

“#” indicates a package specification code.

Size Code 1005 (0402) in mm (in inch),Multilayer Type,High Q, Automotive available (Infotainment)



< List of part numbers with package codes >

LQG15WZ33NH02B LQG15WZ33NH02D LQG15WZ33NH02J

Applications

Unsuitable Applications	Please be sure to read and comply with these "Precautions for use."
Specific Applications	<p>Consumer equipment, Automotive infotainment/comfort equipment, Medical equipment [GHTF A/B/C] except for implant & operation & auto-dispenser equipment, Industrial equipment except for transportation & facility & energy equipment</p> <p>Please refer to Our Website and specifications, etc. for information about the performance, functions, quality, management, and safety required for the above applications, and use Products after confirming the performance and reliability of the actual Product.</p>

References

Packaging	Specifications	Standard Packing Quantity
B	Bulk(Bag)	100
D	180mm Paper Tape	10000
J	330mm Paper Tape	40000

Mass (typ.)	
1 piece	0.001g

Appearance & Shape

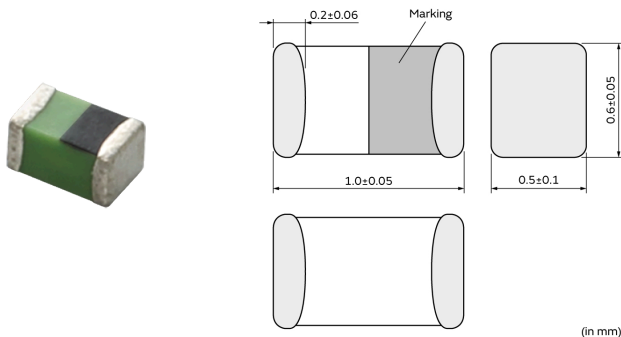

Attention

- This datasheet is downloaded from the website of Murata Manufacturing Co., Ltd. Therefore, its specifications are subject to change or our products in it may be discontinued without advance notice. Please check with our sales representatives or product engineers before ordering.
- This datasheet has only typical specifications because there is no space for detailed specifications. Therefore, please review our product specifications or consult the approval sheet for product specifications before ordering.

LQG15WZ33NH02#

“#” indicates a package specification code.



Specifications

L size	1.0±0.05mm
W size	0.6±0.05mm
T size	0.5±0.1mm
Size code inch (mm)	0402 (1005)
Inductance	33nH±3%
Inductance Test Frequency	100MHz
Rated current (Itemp) (Based on Temperature rise)	220mA
Max. of DC resistance	1.5Ω
Q(min.)	20
Q Test Frequency	250MHz
Self resonance frequency (min.)	1600MHz
Operating Temperature Range(Self-temperature rise is not included)	-55°C to 125°C
Brand	Murata
Series	LQG15WZ_02

Attention

1.This datasheet is downloaded from the website of Murata Manufacturing Co., Ltd. Therefore, it's specifications are subject to change or our products in it may be discontinued without advance notice. Please check with our sales representatives or product engineers before ordering.

2.This datasheet has only typical specifications because there is no space for detailed specifications.

Therefore, please review our product specifications or consult the approval sheet for product specifications before ordering.

LQG15WZ33NH02#

"#" indicates a package specification code.



Characteristic Data

The charts below may show another part number which shares its characteristics.

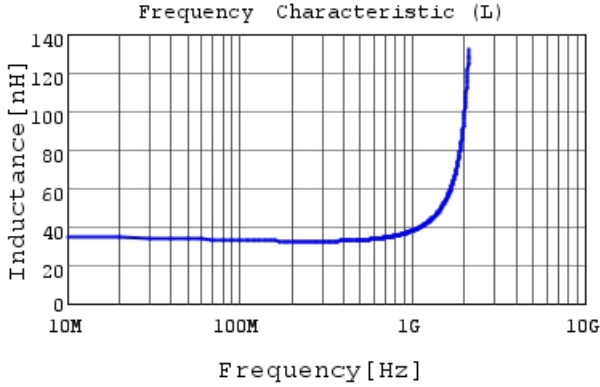

LQG15WZ33NH02 L

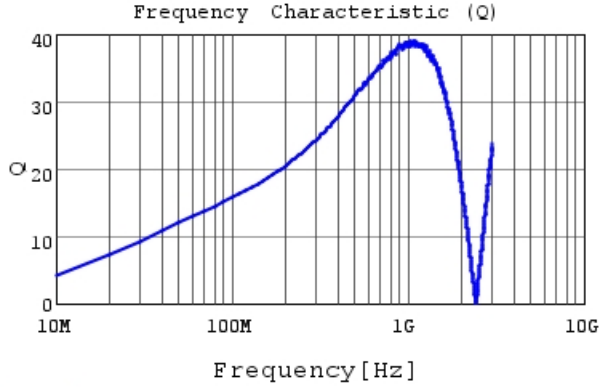

LQG15WZ33NH02 Q

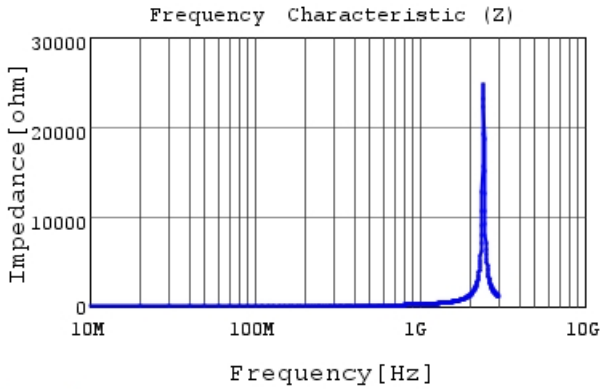

LQG15WZ33NH02 |Z|

Attention

- 1.This datasheet is downloaded from the website of Murata Manufacturing Co., Ltd. Therefore, it's specifications are subject to change or our products in it may be discontinued without advance notice. Please check with our sales representatives or product engineers before ordering.
- 2.This datasheet has only typical specifications because there is no space for detailed specifications.
Therefore, please review our product specifications or consult the approval sheet for product specifications before ordering.