

Fast CMOS Octal D Registers (3-State)

Features:

- Pin compatible with bipolar FAST™ Series at a higher speed and lower power consumption
- TTL input and output levels
- Low ground bounce outputs
- Extremely low static power
- Hysteresis on all inputs
- Industrial operating temperature range: -40°C to +85°C
- Packaging (Pb-free & Green available):
 - 20-pin 173-mil wide plastic TSSOP (L)
 - 20-pin 150-mil wide plastic QSOP (Q)
 - 20-pin 150-mil wide plastic TQSOP (R)
 - 20-pin 209-mil wide plastic SSOP (H)
 - 20-pin 300-mil wide plastic SOIC (S)

Description:

Pericom Semiconductor's PI74FCT374T/574T are 8-bit wide octal registers designed with eight D-type flip-flops with a buffered common clock and buffered 3-state outputs. When output enable (\overline{OE}) is LOW, the outputs are enabled. When \overline{OE} is HIGH, the outputs are in the high impedance state. Input data meeting the setup and hold time requirements of the D inputs is transferred to the O outputs on the LOW-to-HIGH transition of the clock input. Device models available upon request.

Block Diagram

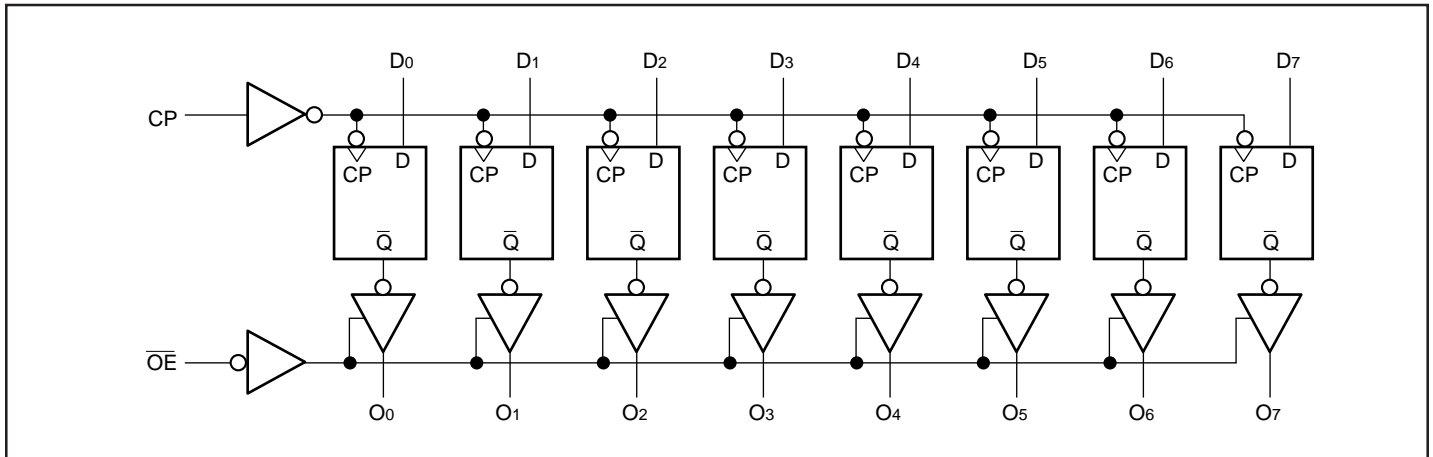

PI74FCT374 Pin Configuration

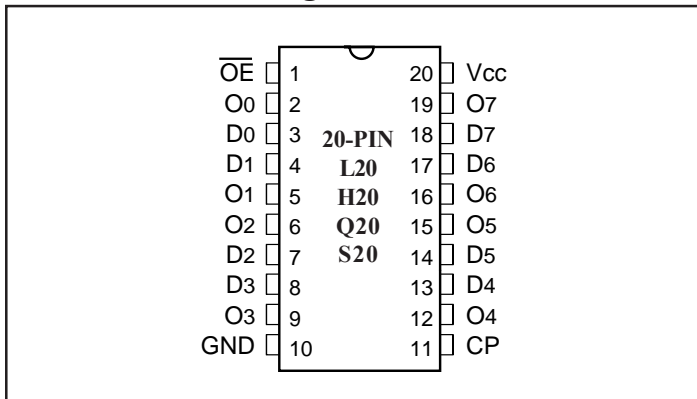

PI74FCT574 Pin Configuration

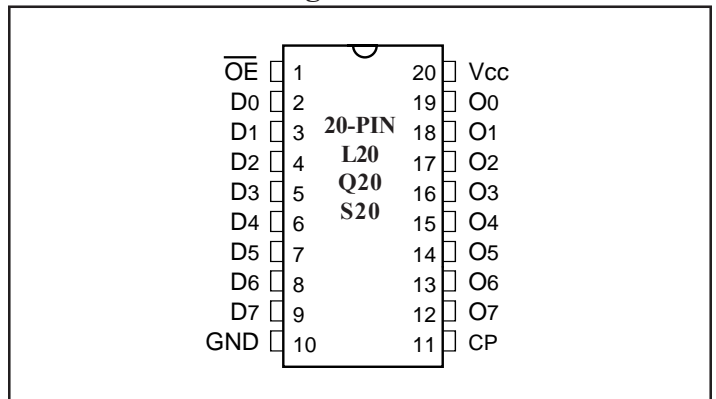

Maximum Ratings

(Above which the useful life may be impaired. For user guidelines, not tested.)

Storage Temperature	-65°C to +150°C
Ambient Temperature with Power Applied	-40°C to +85°C
Supply Voltage to Ground Potential (Inputs & Vcc Only)	-0.5V to +7.0V
Supply Voltage to Ground Potential (Outputs & D/O Only)	-0.5V to +7.0V
DC Input Voltage	-0.5V to +7.0V
DC Output Current	120 mA
Power Dissipation	0.5W

Note:

Stresses greater than those listed under MAXIMUM RATINGS may cause permanent damage to the device. This is a stress rating only and functional operation of the device at these or any other conditions above those indicated in the operational sections of this specification is not implied. Exposure to absolute maximum rating conditions for extended periods may affect reliability.

Truth Table⁽¹⁾

Function	Inputs			Outputs	Internal
	\overline{OE}	CP	D _N	O _N	$\overline{Q_N}$
High-Z	H	L	X	Z	NC
	H	H	X	Z	NC
Load Register	L	↑	L	L	H
	L	↑	H	H	L
	H	↑	L	Z	H
	H	↑	H	Z	L

- H = High Voltage Level
 L = Low Voltage Level
 X = Don't Care
 Z = High Impedance
 NC = No Change
 ↑ = LOW-to-HIGH transition

Pin Description

Pin Name	Description
\overline{OE}	Output Enable Input (Active LOW)
CP	Clock Pulse for the register. Enters data on LOW-to-HIGH transition
D0-D7	Data Inputs
O0-O7	3-State Outputs (true)
O0- $\overline{O7}$	3-State Outputs (inverted)
GND	Ground
Vcc	Power

DC Electrical Characteristics (Over the Operating Range, $T_A = -40^{\circ}\text{C}$ to $+85^{\circ}\text{C}$, $V_{CC} = 5.0\text{V} \pm 5\%$)

Parameters	Description	Test Conditions ⁽¹⁾		Min.	Typ ⁽²⁾	Max.	Units
V _{OH}	Output HIGH Voltage	$V_{CC} = \text{Min.}, V_{IN} = V_{IH} \text{ or } V_{IL}$	$I_{OH} = -15.0 \text{ mA}$	2.4	3.0		V
V _{OL}	Output LOW Current	$V_{CC} = \text{Min.}, V_{IN} = V_{IH} \text{ or } V_{IL}$	$I_{OL} = 64 \text{ mA}$		0.3	0.55	V
V _{OL}	Output LOW Current	$V_{CC} = \text{Min.}, V_{IN} = V_{IH} \text{ or } V_{IL}$	$I_{OL} = 12 \text{ mA (} 25\Omega \text{ Series)}$		0.3	0.50	V
V _{IH}	Input HIGH Voltage	Guaranteed Logic HIGH Level		2.0			V
V _{IL}	Input LOW Voltage	Guaranteed Logic LOW Level				0.8	V
I _{IH}	Input HIGH Current	$V_{CC} = \text{Max.}$	$V_{IN} = V_{CC}$			1	μA
I _{IL}	Input LOW Current	$V_{CC} = \text{Max.}$	$V_{IN} = \text{GND}$			-1	μA
I _{OZH}	High Impedance	$V_{CC} = \text{Max.}$	$V_{OUT} = 2.7\text{V}$			1	μA
I _{OZL}	Output Current		$V_{OUT} = 0.5\text{V}$			-1	μA
V _{IK}	Clamp Diode Voltage	$V_{CC} = \text{Min.}, I_{IN} = -18 \text{ mA}$			-0.7	-1.2	V
I _{OFF}	Power Down Disable	$V_{CC} = \text{GND}, V_{OUT} = 4.5\text{V}$		—	—	100	μA
I _{OS}	Short Circuit Current	$V_{CC} = \text{Max.}^{(3)}, V_{OUT} = \text{GND}$		-60	-120		mA
V _H	Input Hysteresis				200		mV

Capacitance ($T_A = 25^{\circ}\text{C}$, $f = 1 \text{ MHz}$)

Parameters ⁽⁴⁾	Description	Test Conditions	Typ	Max.	Units
C _{IN}	Input Capacitance	$V_{IN} = 0\text{V}$	6	10	pF
C _{OUT}	Output Capacitance	$V_{OUT} = 0\text{V}$	8	12	pF

Notes:

1. For Max. or Min. conditions, use appropriate value specified under Electrical Characteristics for the applicable device type.
2. Typical values are at $V_{CC} = 5.0\text{V}$, $+25^{\circ}\text{C}$ ambient and maximum loading.
3. Not more than one output should be shorted at one time. Duration of the test should not exceed one second.
4. This parameter is determined by device characterization but is not production tested.

Power Supply Characteristics

Parameters	Description	Test Conditions ⁽¹⁾		Min.	Typ ⁽²⁾	Max.	Units
I _{CC}	Quiescent Power Supply Current	V _{CC} = Max.	V _{IN} = GND or V _{CC}		0.1	500	μA
ΔI _{CC}	Supply Current per Input @ TTL HIGH	V _{CC} = Max.	V _{IN} = 3.4V ⁽³⁾		0.5	2.0	mA
I _{CCD}	Supply Current per Input per MHz ⁽⁴⁾	V _{CC} = Max., Outputs Open OE = GND One Input Toggling 50% Duty Cycle	V _{IN} = V _{CC} V _{IN} = GND		0.15	0.25	mA/ MHz
I _C	Total Power Supply Current ⁽⁶⁾	V _{CC} = Max., Outputs Open f _{CP} = 10 MHz 50% Duty Cycle OE = GND fi = 5 MHz One Bit Toggling	V _{IN} = V _{CC} V _{IN} = GND		1.5	3.5 ⁽⁵⁾	mA
			V _{IN} = 3.4V V _{IN} = GND		2.0	5.5 ⁽⁵⁾	
		V _{CC} = Max., Outputs Open f _{CP} = 10 MHz 50% Duty Cycle OE = GND Eight Bits Toggling fi = 2.5 MHz 50% Duty Cycle	V _{IN} = V _{CC} V _{IN} = GND		3.8	7.3 ⁽⁵⁾	
			V _{IN} = 3.4V V _{IN} = GND		6.0	16.3 ⁽⁵⁾	

Notes:

- For conditions shown as Max. or Min., use appropriate value specified under Electrical Characteristics for the applicable device.
- Typical values are at V_{CC} = 5.0V, +25°C ambient.
- Per TTL driven input (V_{IN} = 3.4V); all other inputs at V_{CC} or GND.
- This parameter is not directly testable, but is derived for use in Total Power Supply Calculations.
- Values for these conditions are examples of the I_{CC} formula. These limits are guaranteed but not tested.

6. $I_C = I_{\text{QUIESCENT}} + I_{\text{INPUTS}} + I_{\text{DYNAMIC}}$

$$I_C = I_{CC} + \Delta I_{CC} D_H N_T + I_{CCD} (f_{CP}/2 + f_i N_i)$$

I_{CC} = Quiescent Current

ΔI_{CC} = Power Supply Current for a TTL High Input (V_{IN} = 3.4 V)

D_H = Duty Cycle for TTL Inputs High

N_T = Number of TTL Inputs at D_H

I_{CCD} = Dynamic Current Caused by an Input Transition Pair (HLH or LHL)

f_{CP} = Clock Frequency for Register Devices (Zero for Non-Register Devices)

f_i = Input Frequency

N_i = Number of Inputs at f_i

All currents are in milliamps and all frequencies are in megahertz.

PI74FCT374T Switching Characteristics over Operating Range

Parameters	Description	Conditions ⁽¹⁾	374TT		374AT		374CT		374DT		Units
			Com.		Com.		Com.		Com.		
			Min	Max	Min	Max	Min	Max	Min	Max	
t _{PLH} t _{PHL}	Propagation Delay CP to ON	C _L = 50pF R _L = 500Ω	2.0	10.0	2.0	6.5	2.0	5.2	2.0	4.5	ns
t _{PZH} t _{PZL}	Output Enable Time \overline{OE} to ON		1.5	12.5	1.5	6.5	1.5	5.5	1.5	5.5	ns
t _{PHZ} t _{PLZ}	Output Disable Time ⁽³⁾ \overline{OE} to ON		1.5	8.0	1.5	5.5	1.5	5.0	1.5	5.0	ns
t _{SU}	Setup Time HIGH or LOW, D _N to CP		2.0	—	2.0	—	2.0	—	2.0	—	ns
t _H	Hold Time HIGH or LOW, D _N to CP		1.5	—	1.5	—	1.5	—	1.0	—	ns
t _w	CP Pulse Width ⁽³⁾ HIGH or LOW		7.0	—	5.0	—	5.0	—	3.0	—	ns

PI74FCT574T Switching Characteristics over Operating Range

Parameters	Description	Conditions ⁽¹⁾	574T		574AT		574T		574DT		Units
			Com.		Com.		Com.		Com.		
			Min	Max	Min	Max	Min	Max	Min	Max	
t _{PLH} t _{PHL}	Propagation Delay CP to ON	C _L = 50 pF R _L = 500Ω	2.0	8.5	2.0	6.5	2.0	5.2	2.0	4.5	ns
t _{PZH} t _{PZL}	Output Enable Time \overline{OE} to ON		1.5	10.0	1.5	6.5	1.5	5.5	1.5	5.5	ns
t _{PHZ} t _{PLZ}	Output Disable Time ⁽³⁾ \overline{OE} to ON		1.5	6.5	1.5	5.5	1.5	5.0	1.5	5.0	ns
t _{SU}	Setup Time HIGH or LOW, D _N to CP		2.0	—	2.0	—	2.0	—	2.0	—	ns
t _H	Hold Time HIGH or LOW, D _N to CP		1.5	—	1.5	—	1.5	—	1.0	—	ns
t _w	CP Pulse Width ⁽³⁾ HIGH or LOW		7.0	—	5.0	—	5.0	—	3.0	—	ns

Notes:

1. See test circuit and wave forms.
2. Minimum limits are guaranteed but not tested on Propagation Delays.
3. This parameter is guaranteed but not production tested.

Packaging Mechanical: 20-pin QSOP (Q)

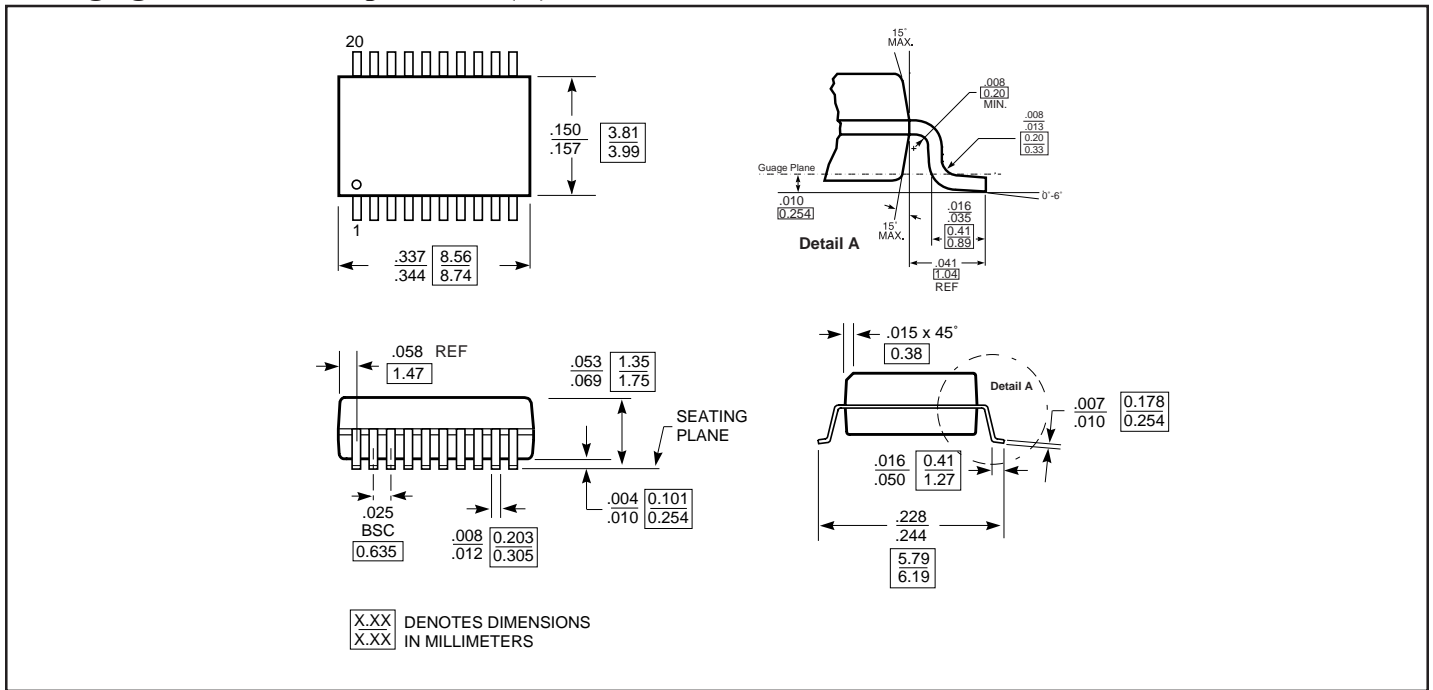

Packaging Mechanical: 20-pin TSSOP (L)

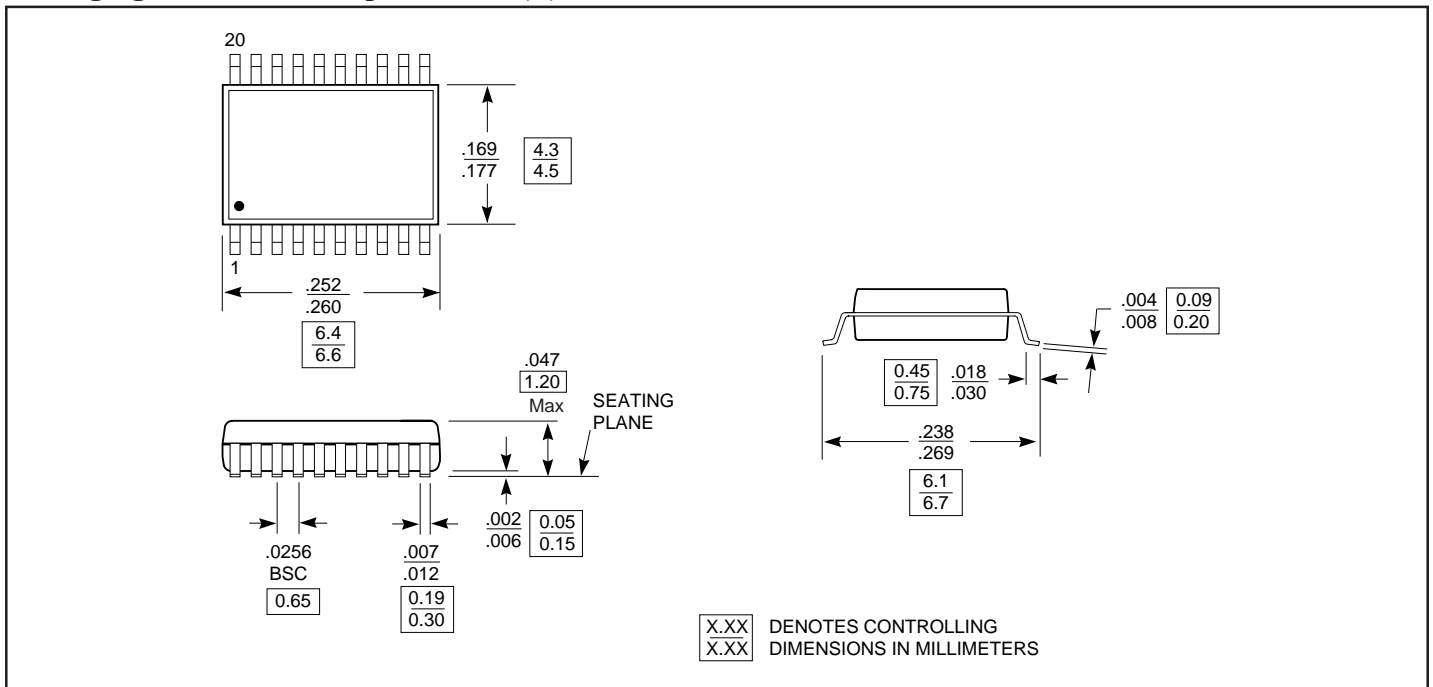

Packaging Mechanical: 20-pin SSOP (H)

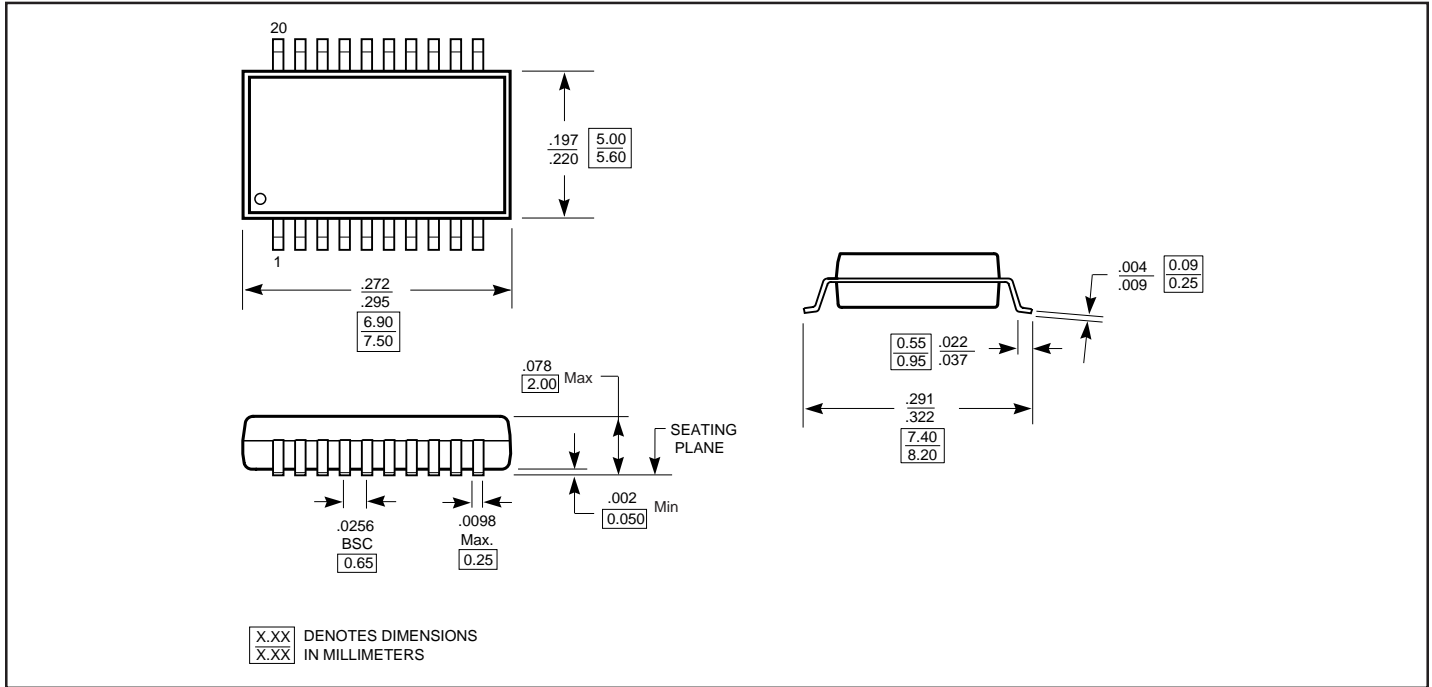

Packaging Mechanical: 20-pin SOIC (S)

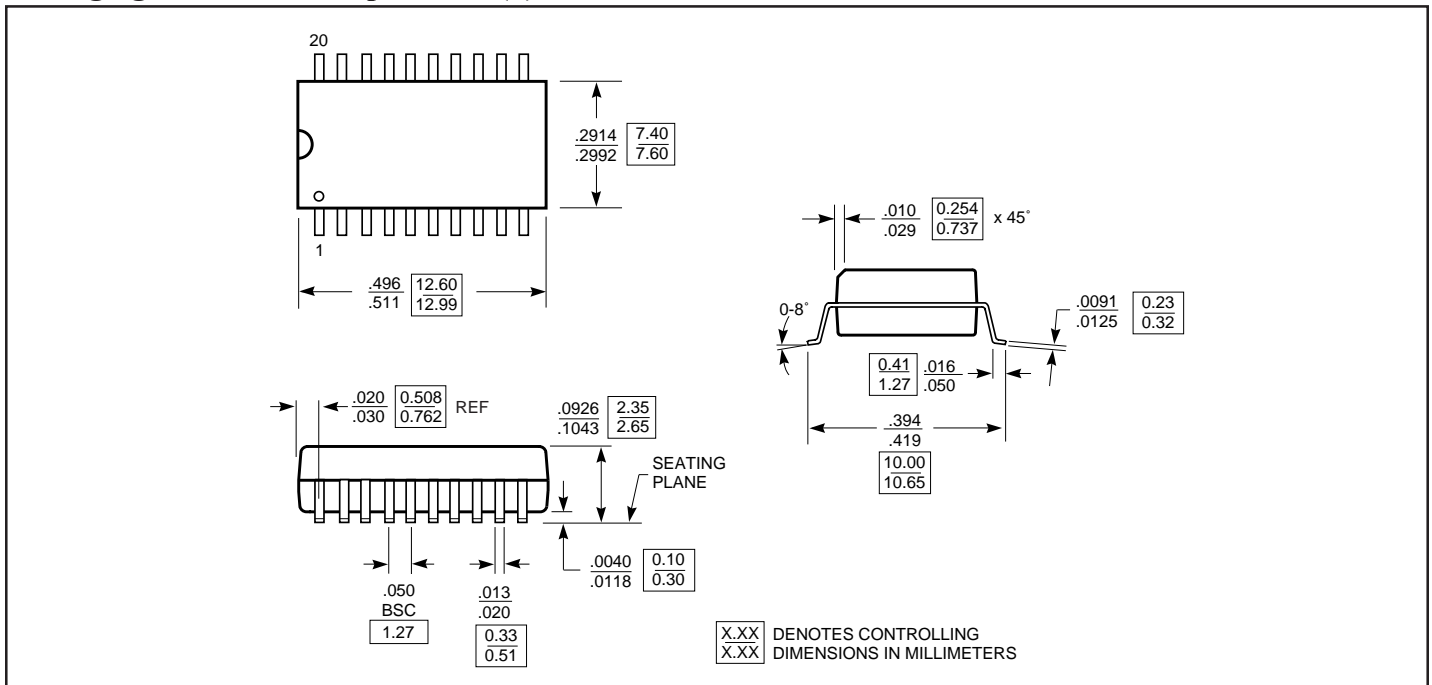

PI74FCT374T Ordering Information

Ordering Code	Package Code	Package Type
PI74FCT374TQ	Q	20-pin QSOP
PI74FCT374TQE	Q	Pb-free & Green, 20-pin QSOP
PI74FCT374TS	S	20-pin SOIC
PI74FCT374TSE	S	Pb-free & Green, 20-pin SOIC
PI74FCT374ATH	H	20-pin SSOP
PI74FCT374ATHE	H	Pb-free & Green, 20-pin SSOP
PI74FCT374ATQ	Q	20-pin QSOP
PI74FCT374ATQE	Q	Pb-free & Green, 20-pin QSOP
PI74FCT374ATS	S	20-pin SOIC
PI74FCT374ATSE	S	Pb-free & Green, 20-pin SOIC
PI74FCT374ATL	L	20-pin TSSOP
PI74FCT374ATLE	L	Pb-free & Green, 20-pin TSSOP
PI74FCT374CTH	H	20-pin SSOP
PI74FCT374CTHE	H	Pb-free & Green, 20-pin SSOP
PI74FCT374CTQ	Q	20-pin QSOP
PI74FCT374CTQE	Q	Pb-free & Green, 20-pin QSOP
PI74FCT374CTS	S	20-pin SOIC
PI74FCT374CTSE	S	Pb-free & Green, 20-pin SOIC
PI74FCT374CTL	L	20-pin TSSOP
PI74FCT374CTLE	L	Pb-free & Green, 20-pin TSSOP
PI74FCT374DTH	H	20-pin SSOP
PI74FCT374DTHE	H	Pb-free & Green, 20-pin SSOP
PI74FCT374CTQ	Q	20-pin QSOP
PI74FCT374CTQE	Q	Pb-free & Green, 20-pin QSOP
PI74FCT374CTL	L	20-pin TSSOP
PI74FCT374CTLE	L	Pb-free & Green, 20-pin TSSOP

Notes:

1. Thermal characteristics can be found on the company web site at www.pericom.com/packaging/

PI74FCT574T Ordering Information

Ordering Code	Package Code	Package Type
PI74FCT574TL	L	20-pin TSSOP
PI74FCT574TLE	L	Pb-free & Green, 20-pin TSSOP
PI74FCT574TQ	Q	20-pin QSOP
PI74FCT574TQE	Q	Pb-free & Green, 20-pin QSOP
PI74FCT574TS	S	20-pin SOIC
PI74FCT574TSE	S	Pb-free & Green, 20-pin SOIC
PI74FCT574ATL	L	20-pin TSSOP
PI74FCT574ATLE	L	Pb-free & Green, 20-pin TSSOP
PI74FCT574ATQ	Q	20-pin QSOP
PI74FCT574ATQE	Q	Pb-free & Green, 20-pin QSOP
PI74FCT574ATS	S	20-pin SOIC
PI74FCT574ATSE	S	Pb-free & Green, 20-pin SOIC
PI74FCT574CTL	L	20-pin TSSOP
PI74FCT574CTLE	L	Pb-free & Green, 20-pin TSSOP
PI74FCT574CTQ	Q	20-pin QSOP
PI74FCT574CTQE	Q	Pb-free & Green, 20-pin QSOP
PI74FCT574CTS	S	20-pin SOIC
PI74FCT574CTSE	S	Pb-free & Green, 20-pin SOIC
PI74FCT574DTQ	Q	20-pin QSOP
PI74FCT574DTQE	Q	Pb-free & Green, 20-pin QSOP
PI74FCT574DTS	S	20-pin SOIC
PI74FCT574DTSE	S	Pb-free & Green, 20-pin SOIC

Notes:

1. Thermal characteristics can be found on the company web site at www.pericom.com/packaging/