

# Type PPC, -55 °C to + 125 °C, Ultra-Thin Polymer Aluminum Electrolytic Capacitor

## High Ripple and DC Holdup



Rated for 125 °C, PPC combines the advantages of aluminum electrolytic and aluminum polymer technology. These capacitors have the ultra-low ESR characteristics of conductive aluminum polymer capacitors in a 1mm thin package. With high capacitance and high ripple current per volume, applications for 125 °C polymer capacitors include DC/DC converters, tablets, telecommunications, thin displays, and variety of industrial power conversion.

### Highlights

- +125 °C, Up to 2,000 Hours Load Life
- Low Leakage Current
- Very Low ESR and High Ripple Current
- Just 1mm thin

### Specifications

Temperature Range	-55 °C to + 125 °C																																																																																															
Rated Voltage	6.3 Vdc – 24 Vdc (see table for derating)																																																																																															
Capacitance	8000 µF - 20,000 µF																																																																																															
Capacitance Tolerance	±20% at 120 Hz and 25 °C																																																																																															
Leakage Current (at 25°C)	I Max = 0.005CV after 2 minute charge I = leakage current in µAmps C = rated capacitance in µF V = rated DC Working voltage in Volts																																																																																															
Low Temperature Characteristics (at 120 Hz)	Z(-55 °C)/Z(+25 °C): ≤ 3.0																																																																																															
Insulation	Nylon																																																																																															
Operating Temperature	-55 °C to + 125 °C																																																																																															
Terminal Material	Tin plated copper (0.010")																																																																																															
Precautions	Do not bend or strike capacitor body																																																																																															
Ripple Current Frequency Multiplier	<table border="1"> <thead> <tr> <th colspan="8">Ripple Multipliers for Ambient Temperature (No Heatsink)</th> </tr> <tr> <th>Ta (°C)</th> <td>45</td> <td>55</td> <td>65</td> <td>75</td> <td>85</td> <td>95</td> <td>105</td> </tr> <tr> <th>Ripple Current Multiplier</th> <td>2.22</td> <td>1.96</td> <td>1.68</td> <td>1.37</td> <td>1.00</td> <td>0.73</td> <td>0.48</td> </tr> </thead> </table> <table border="1"> <thead> <tr> <th colspan="5">Ripple Multipliers for Air Velocity (No Heatsink)</th> </tr> <tr> <th>Air Velocity (m/s)</th> <td>0.25</td> <td>1</td> <td>2.5</td> <td>5</td> </tr> <tr> <th>Ripple Current Multiplier</th> <td>1.00</td> <td>1.36</td> <td>1.52</td> <td>1.66</td> </tr> </thead> </table> <table border="1"> <thead> <tr> <th colspan="8">Ripple Multipliers for Frequency</th> </tr> <tr> <th>Frequency (Hz)</th> <td>50</td> <td>60</td> <td>120</td> <td>360</td> <td>1000</td> <td>5000</td> <td>20000</td> </tr> <tr> <th>Ripple Current Multiplier</th> <td>0.77</td> <td>0.81</td> <td>1.00</td> <td>1.16</td> <td>1.24</td> <td>1.20</td> <td>1.12</td> </tr> </thead> </table> <table border="1"> <thead> <tr> <th colspan="8">Ripple Multipliers for Case Ambient Temperature (Heatsinked to Bus)</th> </tr> <tr> <th>Ta (°C)</th> <td>45</td> <td>55</td> <td>65</td> <td>75</td> <td>85</td> <td>95</td> <td>105</td> </tr> <tr> <th>One Side</th> <td>2.96</td> <td>2.66</td> <td>2.32</td> <td>1.96</td> <td>1.58</td> <td>1.08</td> <td>0.60</td> </tr> <tr> <th>Both Sides</th> <td>3.00</td> <td>3.00</td> <td>3.00</td> <td>2.77</td> <td>2.24</td> <td>1.52</td> <td>0.85</td> </tr> </thead> </table>	Ripple Multipliers for Ambient Temperature (No Heatsink)								Ta (°C)	45	55	65	75	85	95	105	Ripple Current Multiplier	2.22	1.96	1.68	1.37	1.00	0.73	0.48	Ripple Multipliers for Air Velocity (No Heatsink)					Air Velocity (m/s)	0.25	1	2.5	5	Ripple Current Multiplier	1.00	1.36	1.52	1.66	Ripple Multipliers for Frequency								Frequency (Hz)	50	60	120	360	1000	5000	20000	Ripple Current Multiplier	0.77	0.81	1.00	1.16	1.24	1.20	1.12	Ripple Multipliers for Case Ambient Temperature (Heatsinked to Bus)								Ta (°C)	45	55	65	75	85	95	105	One Side	2.96	2.66	2.32	1.96	1.58	1.08	0.60	Both Sides	3.00	3.00	3.00	2.77	2.24	1.52	0.85
Ripple Multipliers for Ambient Temperature (No Heatsink)																																																																																																
Ta (°C)	45	55	65	75	85	95	105																																																																																									
Ripple Current Multiplier	2.22	1.96	1.68	1.37	1.00	0.73	0.48																																																																																									
Ripple Multipliers for Air Velocity (No Heatsink)																																																																																																
Air Velocity (m/s)	0.25	1	2.5	5																																																																																												
Ripple Current Multiplier	1.00	1.36	1.52	1.66																																																																																												
Ripple Multipliers for Frequency																																																																																																
Frequency (Hz)	50	60	120	360	1000	5000	20000																																																																																									
Ripple Current Multiplier	0.77	0.81	1.00	1.16	1.24	1.20	1.12																																																																																									
Ripple Multipliers for Case Ambient Temperature (Heatsinked to Bus)																																																																																																
Ta (°C)	45	55	65	75	85	95	105																																																																																									
One Side	2.96	2.66	2.32	1.96	1.58	1.08	0.60																																																																																									
Both Sides	3.00	3.00	3.00	2.77	2.24	1.52	0.85																																																																																									
Mechanical Shock	MIL-STD-202, Method 213, Condition I, 100 G peak, 6mS, Sawtooth, 18 Shocks																																																																																															

## Type PPC, -55 °C to + 125 °C, Ultra-Thin Polymer Aluminum Electrolytic Capacitor

<b>Vibration Test</b>	<p><b>Level</b> The specimens, while deenergized or operating under the load conditions specified, shall be subjected to the vibration amplitude, frequency range, and duration specified for each case size. Level = 10g</p> <p><b>Amplitude</b> The specimens shall be subjected to a simple harmonic motion having an amplitude of either 0.06-inch double amplitude (maximum total excursion) or peak level specified above, whichever is less. The tolerance on vibration amplitude shall be ±10 percent.</p> <p><b>Frequency Range</b> The vibration frequency shall be varied logarithmically between the approximate limits of 10 to 2,000 Hz.</p> <p><b>Sweep Time and Duration</b> The entire frequency range of 10 to 2,000 Hz and return to 10 Hz shall be traversed in 20 minutes. This cycle shall be performed 12 times in each of three mutually perpendicular directions (total of 36 times), so that the motion shall be applied for a total period of approximately 12 hours. Interruptions are permitted provided the requirements for rate of change and test duration are met.</p> <p><b>Mounting</b> Recommended mounting with 3M double sided VHB tape appropriate for mounting surfaces and to ensure the entire capacitor surface is held rigid.</p>
<b>Altitude</b>	10,000 Feet
<b>Endurance Life Test</b>	<p>Apply the maximum rated voltage for 2,000 hrs at +85 °C with full rated ripple current. After the test, return the capacitor to room temperature for 24 hours and then test.</p> <p><math>\Delta C</math> at 120Hz/+25 °C: ±20% of the initial</p> <p>ESR at 120Hz/+25 °C: ESR ≤ 200% of the initial</p> <p>DCL after 2 minute charge/+25 °C: ≤ 0.005CV</p>
<b>Shelf Life Test</b>	<p>Subject the capacitor to 1000 hrs at +125 °C without voltage. After the test, return the capacitor to room temperature for 24 hours and then test.</p> <p><math>\Delta C</math> at 120Hz/+25 °C: ±20% of the initial</p> <p>ESR at 120Hz/+25 °C: ESR ≤ 200% of the initial</p> <p>DCL after 2 minute charge/+25 °C: ≤ 0.005CV</p>
<b>Moisture Resistance Test</b>	<p>MIL-STD-202, method 106. After the test, return the capacitor to room temperature for 24 hours and then test.</p> <p><math>\Delta C</math> at 120Hz/+25 °C: ±20% of the initial</p> <p>ESR at 120Hz/+25 °C: ESR ≤ 200% of the initial</p> <p>DCL after 2 minute charge/+25 °C: ≤ 0.005CV</p>
<b>Charge/Discharge Test</b>	<p>Charge to rated Vdc and discharge to 0 Vdc, 100,000 cycles at 0.1 Hz, through a 0.22Ω resistor @ 25C. After the test, return the capacitor to room temperature or 24 hours and then test.</p> <p><math>\Delta C</math> at 120Hz/+25 °C: ±20% of the initial</p> <p>ESR at 120Hz/+25 °C: ESR ≤ 200% of the initial</p> <p>DCL after 2 minute charge/+25 °C: ≤ 0.005CV</p>
<a href="#">Regulatory Information</a>	

# Type PPC, -55 °C to + 125 °C, Ultra-Thin Polymer Aluminum Electrolytic Capacitor

## Outline Drawing

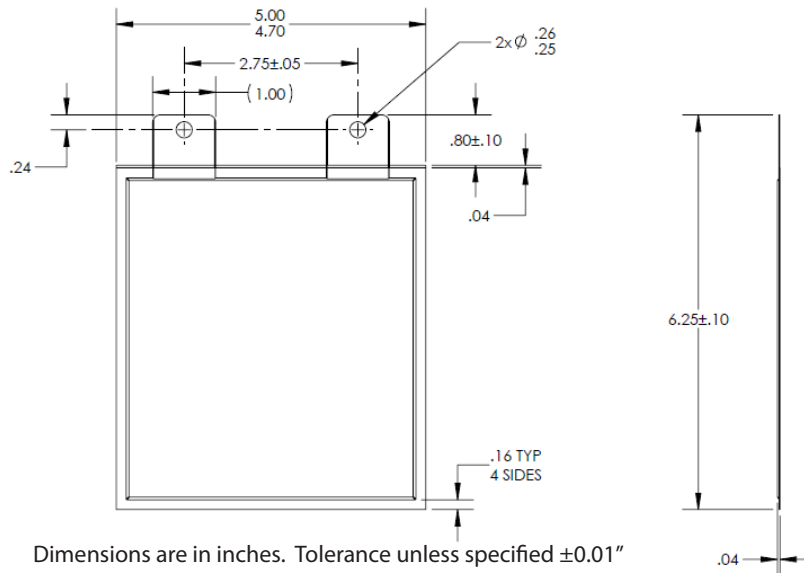

## Examples of Ripple Current Capability Calculations

Application	Application Frequency	Catalog Frequency Multiplier	Application Temperature $T_A$ °C	Catalog Temperature Multiplier	Rated Ripple Arms 120Hz	Ripple Capability Arms
No heat sink	120Hz	1	85	1	16	16.0
No heat sink	120Hz	1	45	2.22	16	35.5
One side heat sinked	120Hz	1	85	1.58	16	25.3
Both sides heat sinked	120Hz	1	65	3	16	48.0
No heat sink	1KHz	1.24	85	1	16	19.8
No heat sink	1KHz	1.24	45	2.22	16	44.0
One side heat sinked	1KHz	1.24	85	1.58	16	31.3
Both sides heat sinked	1KHz	1.24	65	3	16	59.5
No heat sink	20KHz	1.12	85	1	16	17.9
No heat sink	20KHz	1.12	45	2.22	16	39.8
One side heat sinked	20KHz	1.12	85	1.58	16	28.3
Both sides heat sinked	20KHz	1.12	65	3	16	53.8

## Ratings

Rated Voltage			Cap $\mu$ F	P/N	120 Hz 25 °C Max ESR ( $\Omega$ )	20 KHz 25 °C Max ESR (234)	Max Ripple 120 Hz (Arms)	Max Ripple 20 kHz (Arms)	Surge 25 °C Vdc
125 °C Vdc	105 °C Vdc	85 °C Vdc							
6.3	8	9	20000	PPC203M6R3FG2SAA	0.01	0.006	16	18	11
10	12	15	12000	PPC123M010FG2SAA	0.01	0.006	16	18	18
16	20	24	8000	PPC802M016FG2SAA	0.01	0.006	16	18	28

## Part Numbering System

TYPE	CAP	CAP TOL	VDC	WIDTH	LENGTH	TERM STYLE	SPEC CH1	SPEC CH2
PPC	802	M	016	F	G	2S	A	A
<b>PPC</b>	<b>320</b> = 32 $\mu$ F	$\pm 20\%$	<b>6R3</b> = 6.3 Vdc See Outline Drawing			<b>2S</b> - TWO SOLDER-ABLE/BOLT / STUD	ASSIGNED BY MFG	ASSIGNED BY MFG
	<b>222</b> = 2200 $\mu$ F		<b>010</b> = 10 Vdc					
	<b>163</b> = 16000 $\mu$ F		<b>016</b> = 16 Vdc					

# Type PPC, -55 °C to + 125 °C, Ultra-Thin Polymer Aluminum Electrolytic Capacitor

## Recommended Mounting

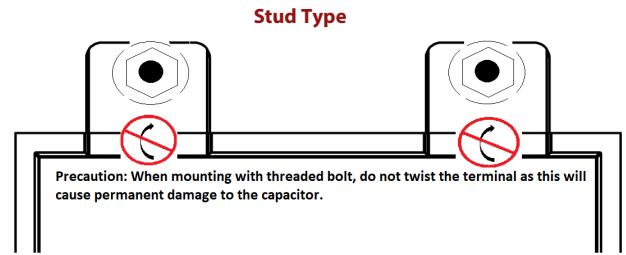
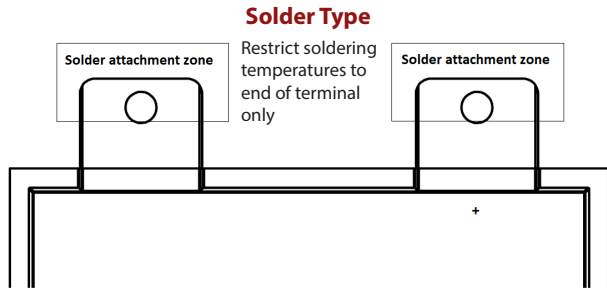

Hardware:  
M5 =#10 stud / bolt  
Copper flat washer, #10 or M5 washer with (~.500") OD

Precaution: Ensure proper terminal spacing and stud / bolt size.

## Capacitor Temperature Characteristics

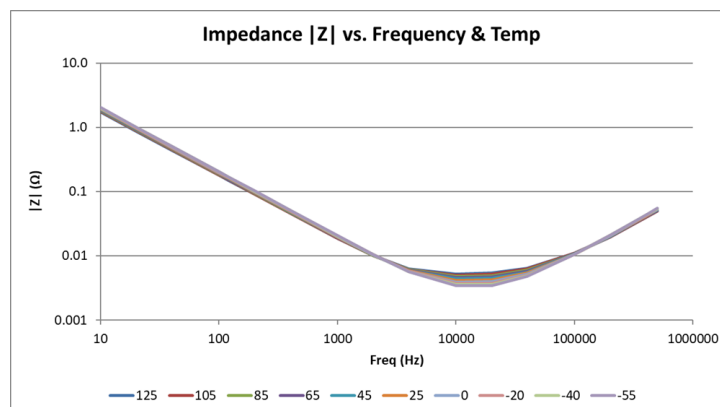
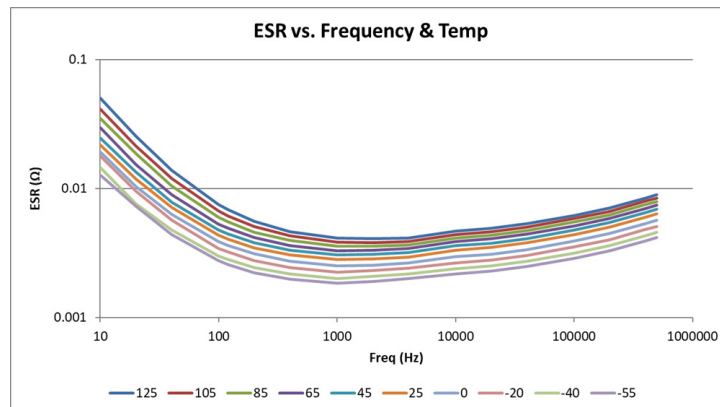
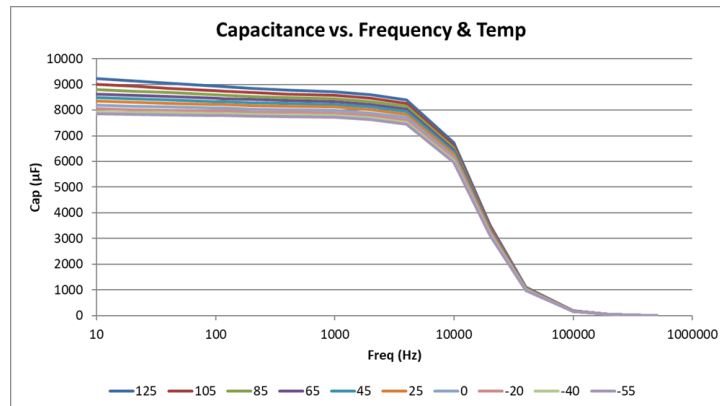

# Type PPC, -55 °C to + 125 °C, Ultra-Thin Polymer Aluminum Electrolytic Capacitor

## Test Results

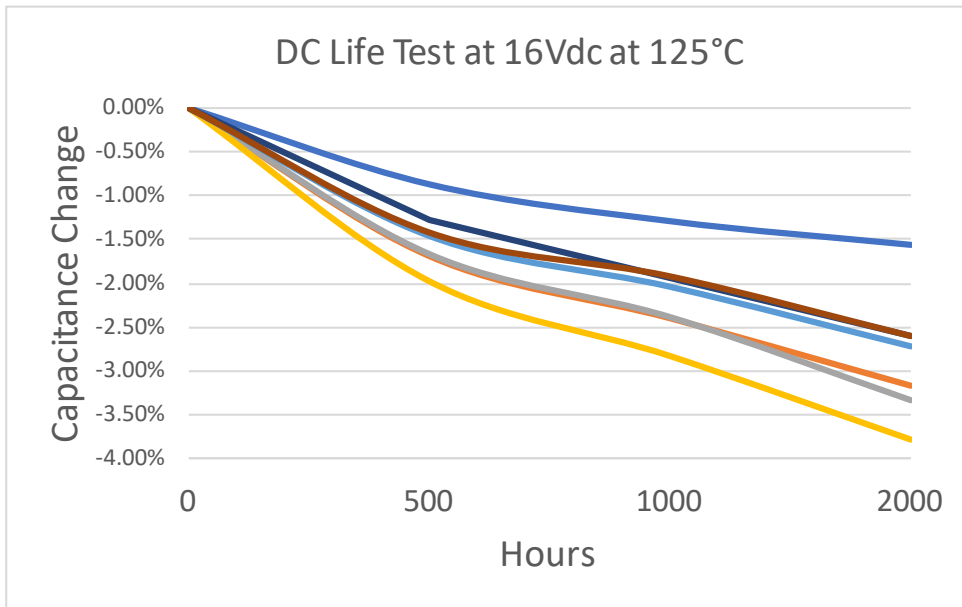

This graph represents 8 units on test for 2,000 hours

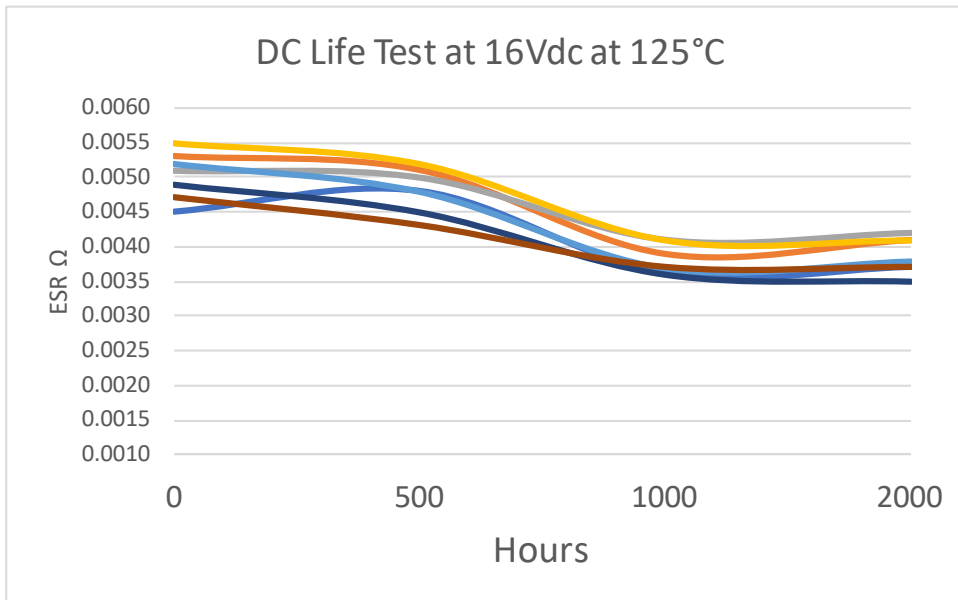

This graph represents 8 units on test for 2,000 hours

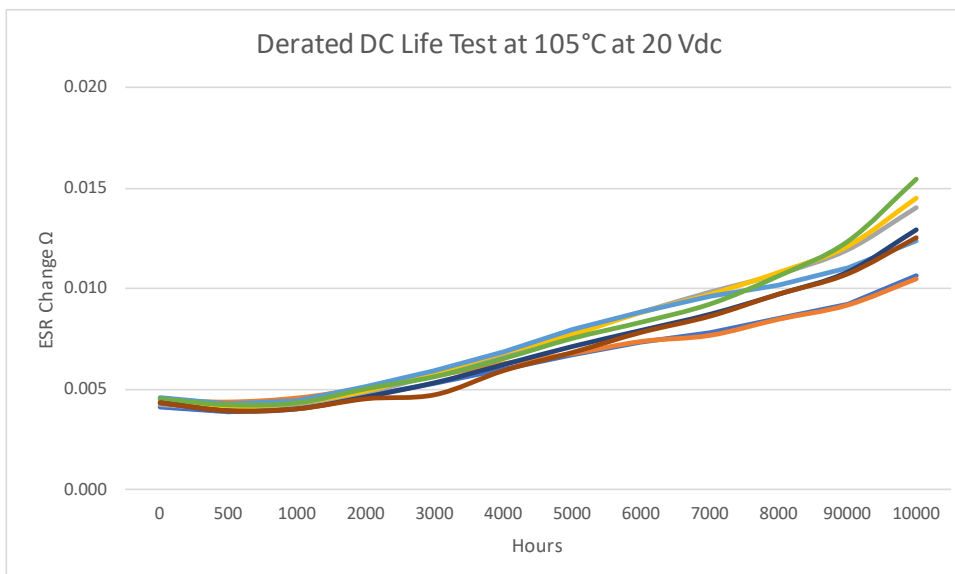

This graph represents 8 units on test for 10,000 hours

**Type PPC, -55 °C to + 125 °C, Ultra-Thin Polymer Aluminum Electrolytic Capacitor**

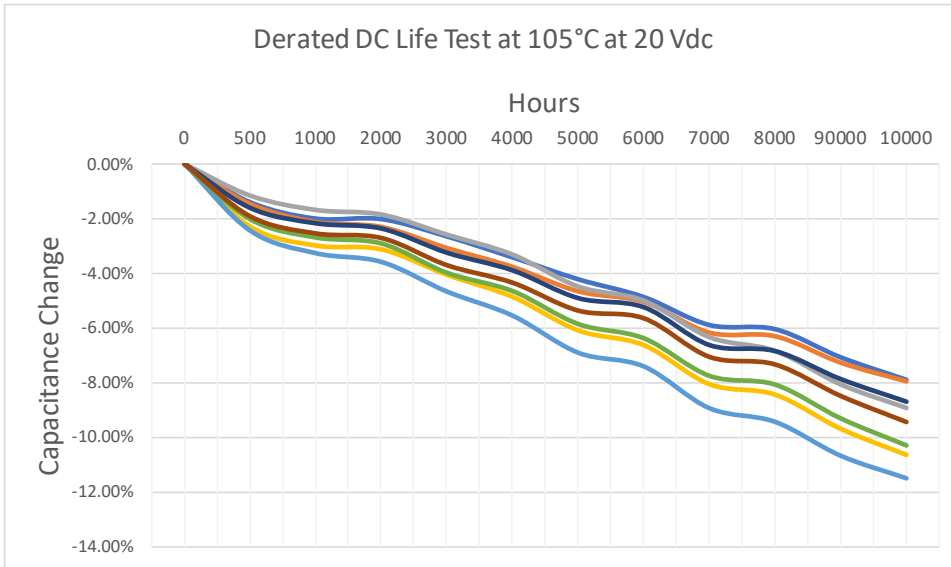

This graph represents 8 units on test for 10,000 hours

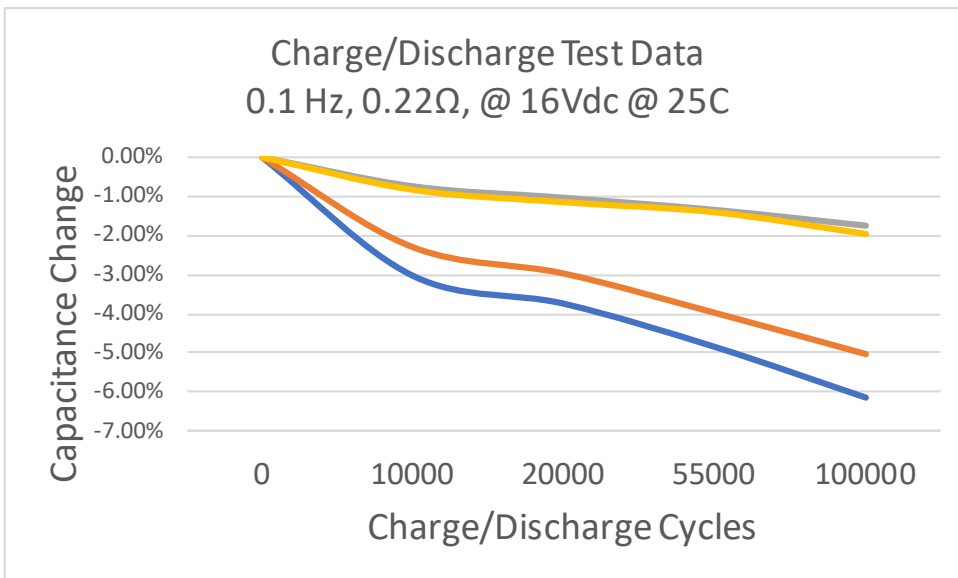

This graph represents 4 units on test for 100,000 cycles

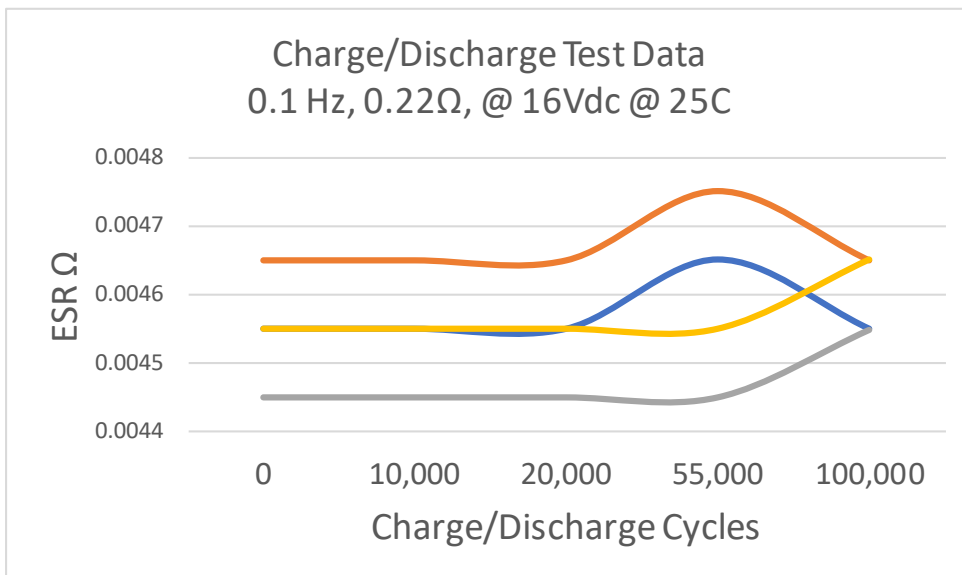

This graph represents 4 units on test for 100,000 cycles

# Type PPC, -55 °C to + 125 °C, Ultra-Thin Polymer Aluminum Electrolytic Capacitor Thermal Model

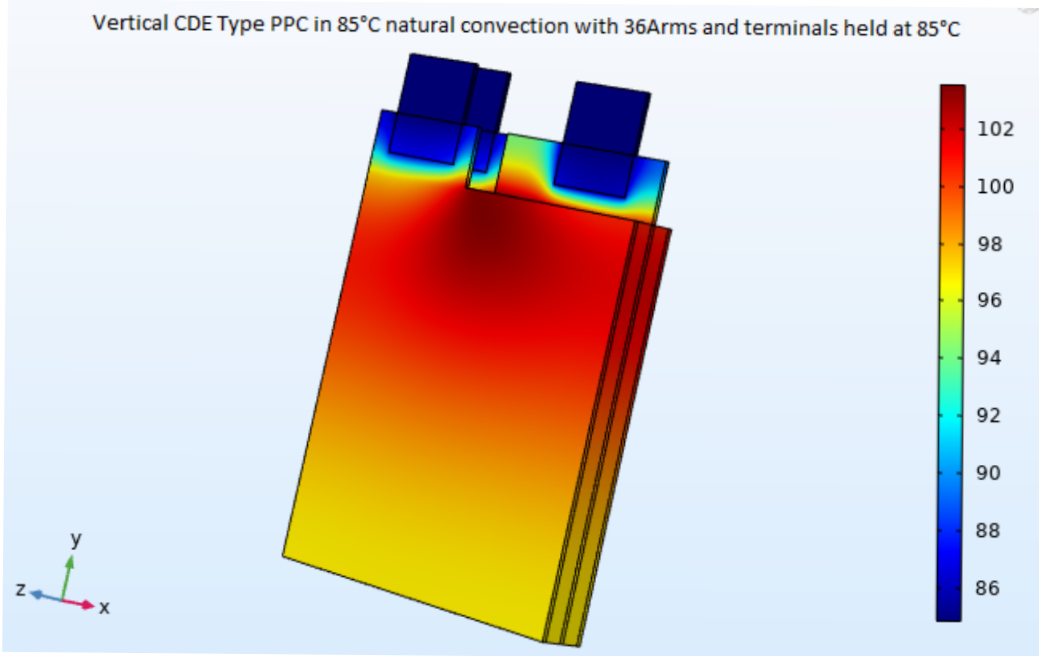

Z dimension is not to scale

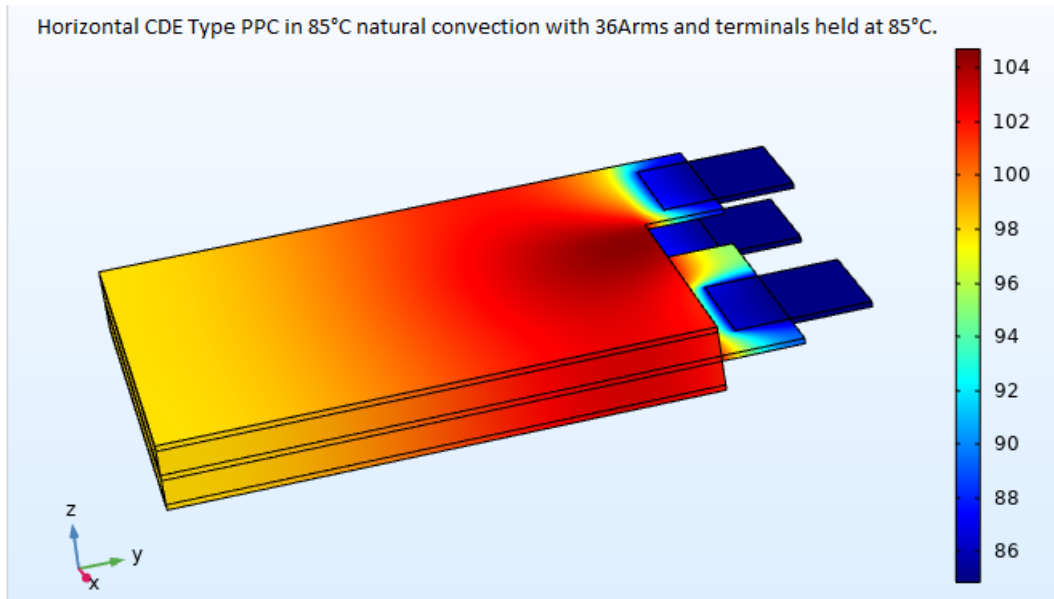

Z dimension is not to scale

**Notice and Disclaimer:** All product drawings, descriptions, specifications, statements, information and data (collectively, the "Information") in this datasheet or other publication are subject to change. The customer is responsible for checking, confirming and verifying the extent to which the Information contained in this datasheet or other publication is applicable to an order at the time the order is placed. All Information given herein is believed to be accurate and reliable, but it is presented without any guarantee, warranty, representation or responsibility of any kind, expressed or implied. Statements of suitability for certain applications are based on the knowledge that the Cornell Dubilier company providing such statements ("Cornell Dubilier") has of operating conditions that such Cornell Dubilier company regards as typical for such applications, but are not intended to constitute any guarantee, warranty or representation regarding any such matter – and Cornell Dubilier specifically and expressly disclaims any guarantee, warranty or representation concerning the suitability for a specific customer application, use, storage, transportation, or operating environment. The Information is intended for use only by customers who have the requisite experience and capability to determine the correct products for their application. Any technical advice inferred from this Information or otherwise provided by Cornell Dubilier with reference to the use of any Cornell Dubilier products is given gratis (unless otherwise specified by Cornell Dubilier), and Cornell Dubilier assumes no obligation or liability for the advice given or results obtained. Although Cornell Dubilier strives to apply the most stringent quality and safety standards regarding the design and manufacturing of its products, in light of the current state of the art, isolated component failures may still occur. Accordingly, customer applications which require a high degree of reliability or safety should employ suitable designs or other safeguards (such as installation of protective circuitry or redundancies or other appropriate protective measures) in order to ensure that the failure of an electrical component does not result in a risk of personal injury or property damage. Although all product-related warnings, cautions and notes must be observed, the customer should not assume that all safety measures are indicated in such warnings, cautions and notes, or that other safety measures may not be required.