

2 Installing the Decorative Cover

To connect a 1.5" NPT pipe to the mounted adapter plate, twist the male threaded end to the female thread on the adapter. Using allen key (I), tighten screws (D or E) onto the pipe and secure the position. Then pull the decorative cover (B) up the pipe to conceal the adapter plate (A) for a neat look.

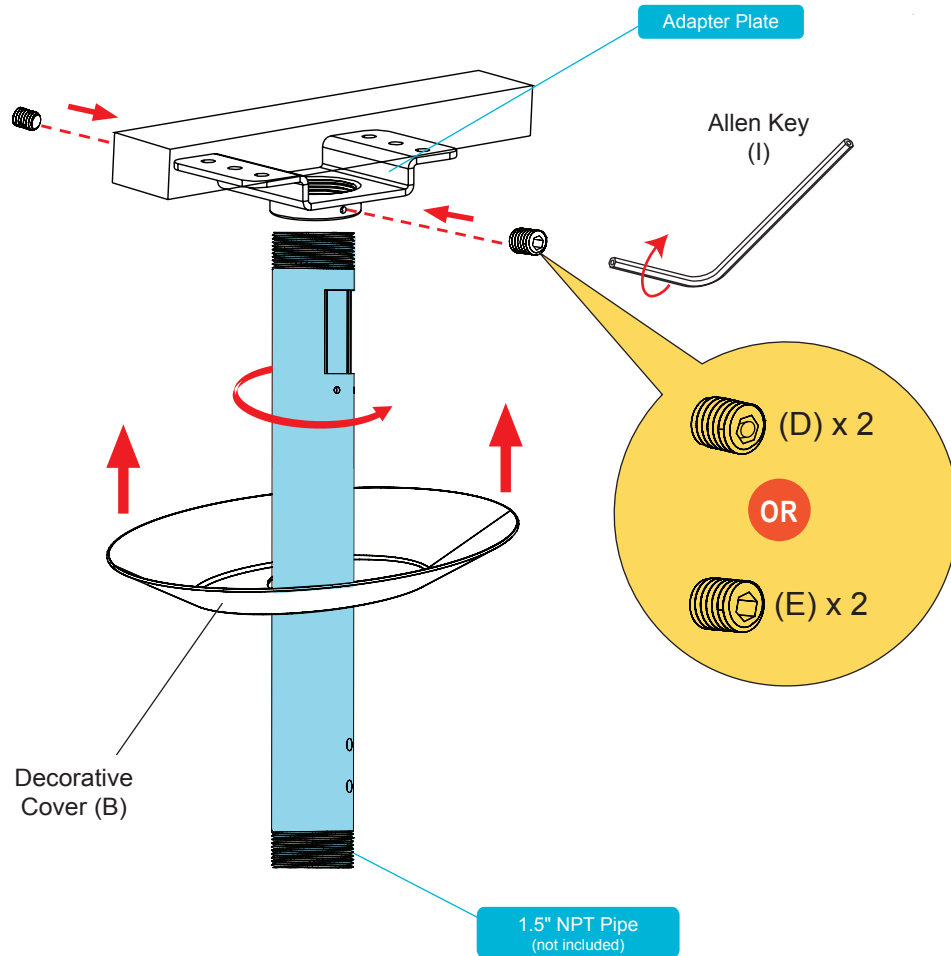

IMPORTANT!

Do not loosen screws all the way when making adjustments, this will disconnect the parts and may cause injury or property damage.

QualGear®

Accessories that Inspire.

QG-PRO-PM-CA-B
QG-PRO-PM-CA-W
INSTALLATION MANUAL

SINGLE JOIST CEILING ADAPTER WITH COVER



www.qualgear.com

54.5kg
(120lbs)
RATED

CAUTION!

Do not exceed the maximum rated weight specified. Otherwise, serious injury or property damage may occur.



■ 5 Year Limited Warranty

■ Version November 2015

NOTE Please read the entire installation manual before you start installation and assembly.

WARNING

- Do not begin to install your QualGear product until you have read and understood all the instructions and warnings contained in this installation manual. If you have any questions regarding the instructions, for US customers please contact QualGear customer support via email at support@qualgear.com. For all international customers, please contact your local distributor.
- This product should only be installed by someone of good mechanical aptitude, has experience with basic building construction, and fully understands these instructions.
- This product was designed to be installed and utilized only as specified in this manual. Improper installation of this product may cause damage or serious injury. QualGear is not liable for the improper use or installation of its products.
- Make sure that the supporting surface will safely support the combined load of the equipment and all attached hardware and components.
- Always use an assistant or mechanical lifting equipment to safely lift and position the equipment.
- Tighten screws firmly, but do not over tighten. Over tightening can damage the items, greatly reducing their holding power.
- ALL QUALGEAR products are intended for indoor use only and any outdoor use voids the limited warranty. For warranty information, please visit:
<http://www.qualgear.com/warranty.php>
- Never exceed the maximum rated weight specified in this manual.
- All hardware must be used at the designated points in the installation instructions to prevent property damage and/or personal injury.
- This product was designed to be compatible with all standard 1.5" NPT pipes.

 **IMPORTANT:** Installers must verify that the supporting surface will safely support the combined weight of the equipment and all attached hardware and components.

Maintenance

Please check that the ceiling adapter is secure and safe to use at regular intervals. If you have any questions regarding any of the instructions or warnings, please contact your local distributor (OR) contact QualGear technical support via email at support@qualgear.com.

Parts Checklist

 **IMPORTANT:** Before starting installation, please check that all parts shown in this checklist are included. If any parts are missing or damaged, contact your local distributor or support@qualgear.com for replacement parts and do not start assembly and installation until you receive all the parts.

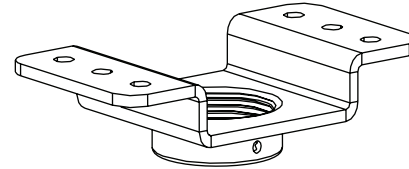

Adapter Plate
A (x1)

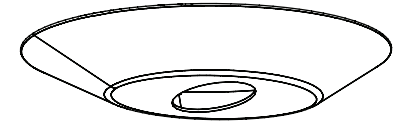

Decorative Cover
B (x1)

Hardware Package

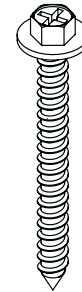

Screws
C (x2)



M5 x 5mm Security Screws
D (x2)



M5 x 5mm Screws
E (x2)



Metal Expansion Anchors
F (x4)



M6 Washer
G (x2)



Wall Marking Template
H (x1)



Allen Key
I (x1)

1a Mounting to a Wooden Joist or Wooden Stud Ceiling

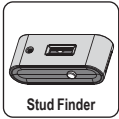

NOTE For concrete ceiling mounting, follow step 1b.

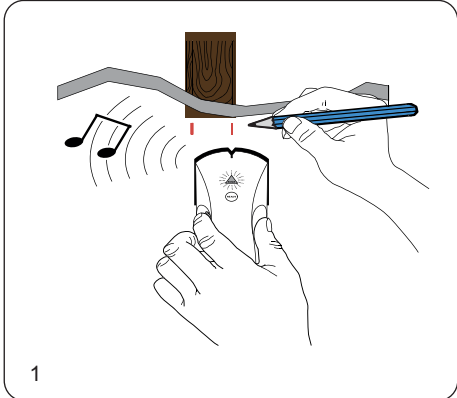

1

Using an edge-to-edge stud finder, find the edges of the stud.

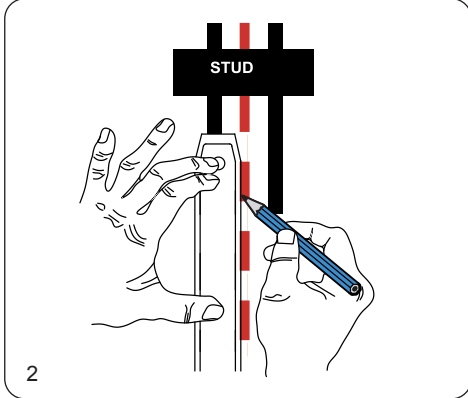

2

Using a straight edge, mark the centerline of the stud.

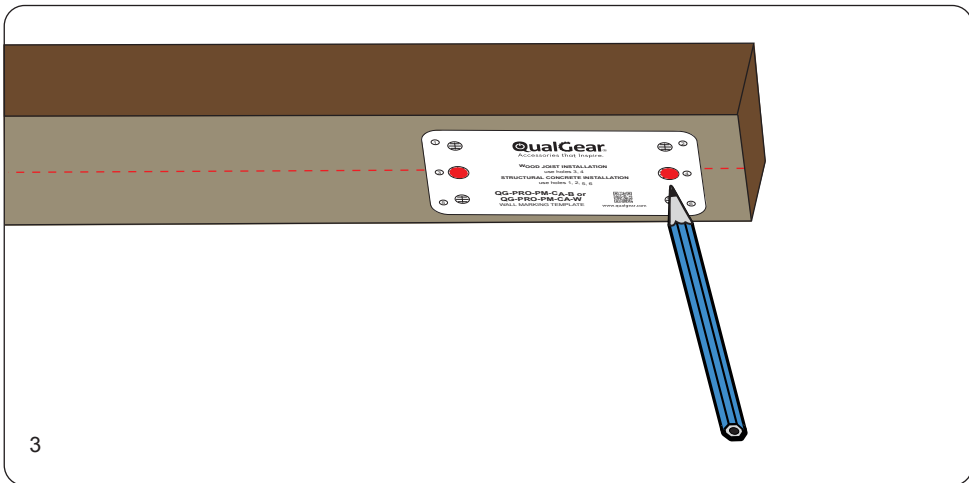

3

Using wall marking template (H), mark on the center of the stud the locations of where you want to mount the ceiling adapter.

TIP Mark the drill locations on the center of the studs for security.

SKIP TO STEP 2 →

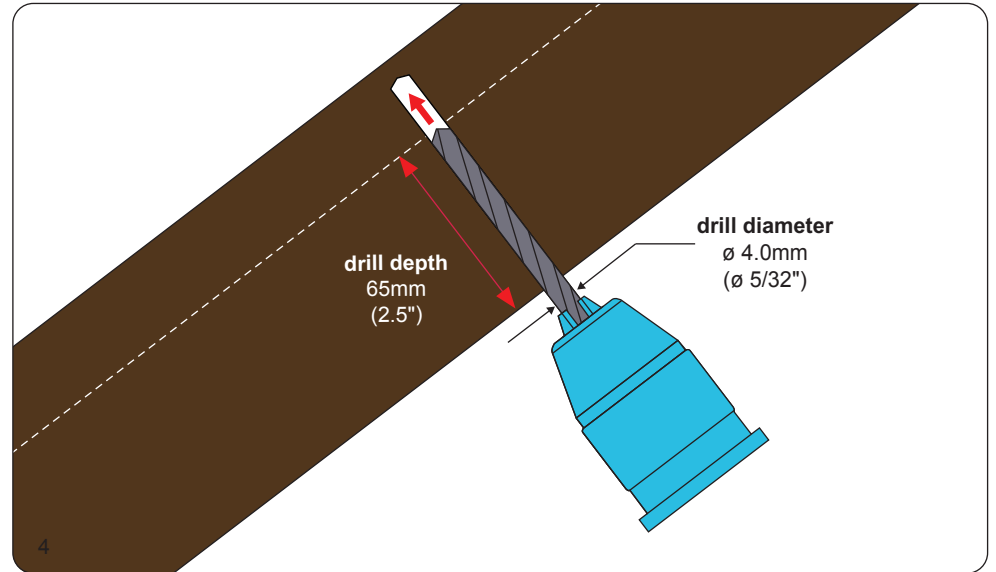

4

Using a power drill and a 5/32" wood drill bit, drill holes of 5/32" (4mm) diameter, and 2.5" (65mm) depth at the marked locations.

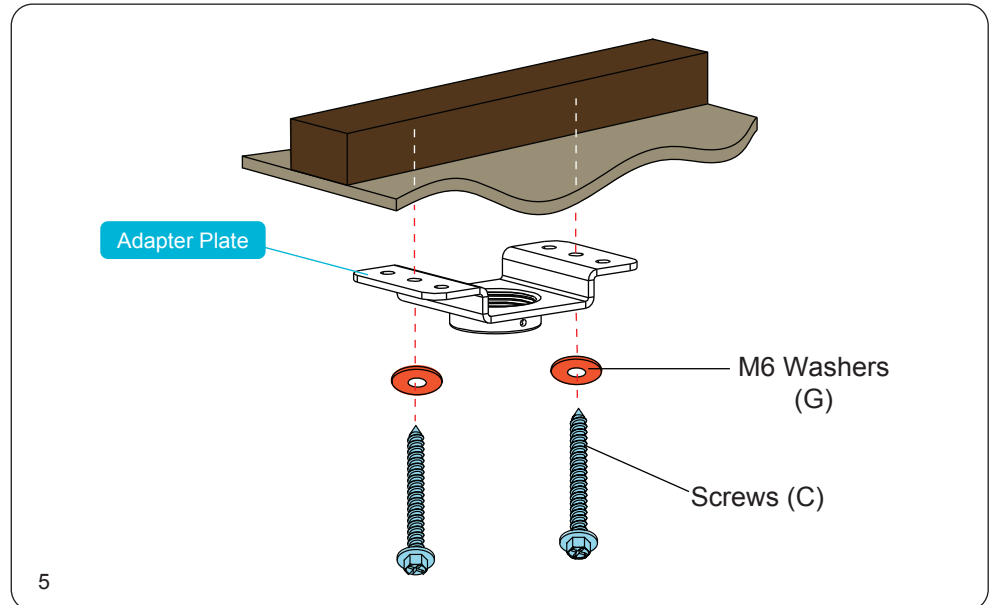

5

Align the mounting holes on the adapter plate (A) with the drilled holes and then tighten screws (C) and washers (G) with a socket wrench.

1b Mounting to a Concrete Ceiling

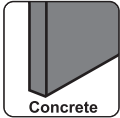

Concrete



TIP

Make sure drilled holes are free of dust so the anchors will be set properly.

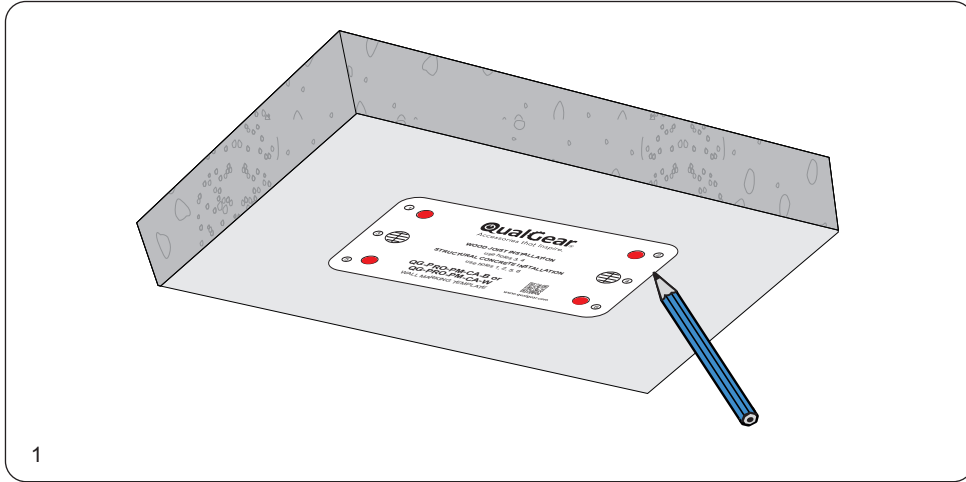

1

Using wall marking template (H), mark on the concrete the locations of where you want to mount the ceiling adapter.

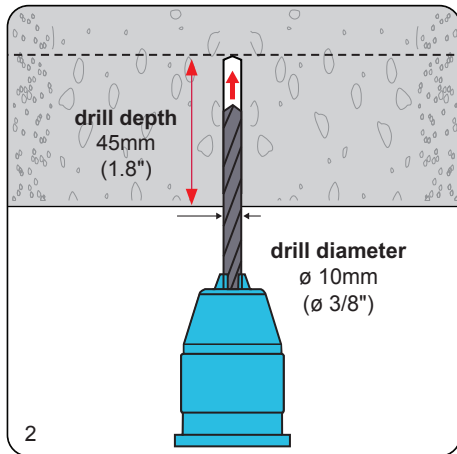

2

Using a power drill and a 1/4" masonry drill bit, drill four holes of 1/4" (6.0 mm) diameter and 1.5" (38 mm) depth at the marked locations.

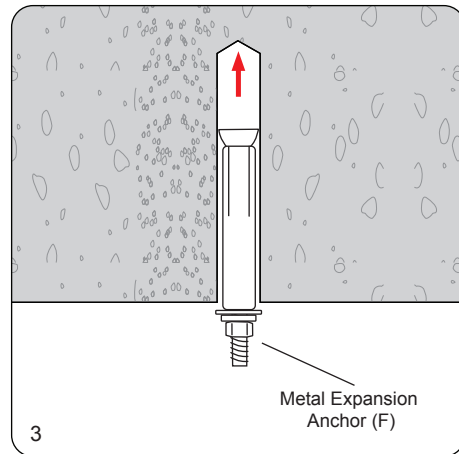

3

Insert and hammer the metal expansion anchors (F) into the drilled holes, then take off the washers and the nuts on the anchor with a socket wrench.

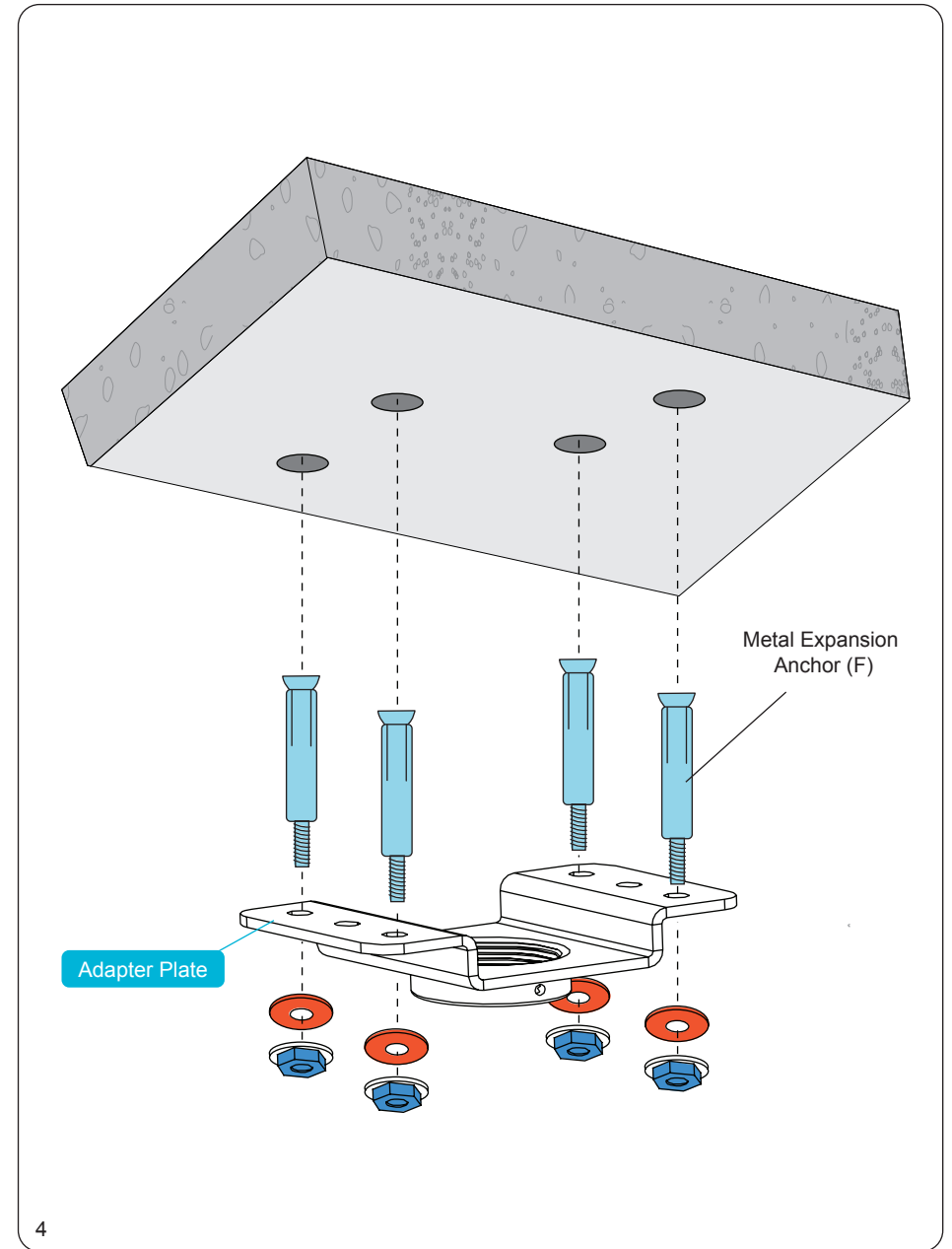

4

After setting the metal expansion anchors (F) into the drilled holes, align them with the mounting holes on the adapter plate. Then place the washers and the nuts from the end of the anchors and tighten with a socket wrench.