

FEATURES

- Dual 16-bit ADC family
- Dual simultaneous sampling
- Pseudo differential analog inputs
- Throughput conversion rate
 - 1 MSPS for the AD4682
 - 500 kSPS for the AD4683
- SNR (typical)
 - 87.5 dB, $V_{REF} = 3.3\text{ V}$ external
 - 93.4 dB with $RES = 1$ and $OSR = \times 8$
- On-chip oversampling function
- Alert function
- Resolution boost function
- INL error (maximum): 2.5 LSBs
- 2.5 V internal reference
- High speed serial interface
- 40°C to +125°C operation
- 3 mm × 3 mm, 16-lead LFCSP

APPLICATIONS

- Motor control position feedback
- Motor control current sense
- Sonar
- Power quality
- Data acquisition systems
- Erbium doped fiber amplifier (EDFA) applications
- Inphase (I) and quadrature (Q) demodulation

GENERAL DESCRIPTION

The AD4682 and the AD4683 are a 16-bit, pin-compatible family of dual, simultaneous sampling, high speed, low power, successive approximation register (SAR), analog-to-digital converters (ADCs) that operate from a 3.0 V to 3.6 V power supply and feature throughput rates up to 1 MSPS for the AD4682 and 500 kSPS for the AD4683. The analog input type is pseudo differential and is sampled and converted on the falling edge of \overline{CS} .

Integrated on-chip oversampling blocks improve dynamic range and reduce noise at lower bandwidths. A buffered internal 2.5 V reference is included. Alternatively, an external reference up to 3.3 V can be used.

The conversion process and data acquisition use standard control inputs that allow simple interfacing to microprocessors or digital signal processors (DSPs). The devices are compatible with 1.8 V, 2.5 V, and 3.3 V interfaces, using a separate logic supply.

COMPANION PARTS

- ADC Drivers: [ADA4896-2](#), [ADA4940-2](#), [ADA4807-2](#), [LTC6227](#)
- Voltage References: [ADR4533](#) (3.3 V), [ADR4525](#) (2.5 V)
- Low Dropout Regulators: [ADP166](#), [ADP7104](#), [ADP7182](#)
- Additional companion products on the AD4682 and AD4683 [product pages](#)

Table 1. Related Devices in the Family

Input Type	16-Bit	14-Bit	12-Bit
Differential	AD7380	AD7381	
Pseudo Differential	AD7383	AD7384	
Single-Ended	AD7386	AD7387	AD7388

FUNCTIONAL BLOCK DIAGRAM

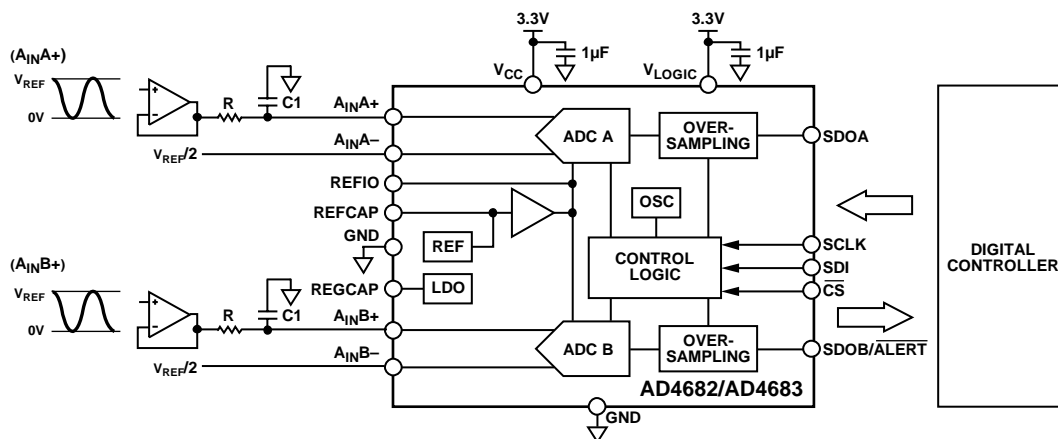

Figure 1.

23411-001

Rev. 0

Document Feedback

Information furnished by Analog Devices is believed to be accurate and reliable. However, no responsibility is assumed by Analog Devices for its use, nor for any infringements of patents or other rights of third parties that may result from its use. Specifications subject to change without notice. No license is granted by implication or otherwise under any patent or patent rights of Analog Devices. Trademarks and registered trademarks are the property of their respective owners.

TABLE OF CONTENTS

Features	1	Oversampling	18
Applications	1	Resolution Boost	18
General Description	1	Alert.....	19
Companion Parts.....	1	Power Modes	19
Functional Block Diagram	1	Internal and External Reference	20
Revision History	2	Software Reset.....	20
Specifications	3	Diagnostic Self Test.....	20
Timing Specifications	5	Interface	21
Absolute Maximum Ratings	7	Reading Conversion Results.....	21
Thermal Resistance	7	Low Latency Readback.....	22
Electrostatic Discharge (ESD) Ratings.....	7	Reading from Device Registers	23
ESD Caution.....	7	Writing to Device Registers.....	23
Pin Configuration and Function Descriptions	8	CRC.....	24
Typical Performance Characteristics.....	9	Registers.....	26
Terminology.....	13	Addressing Registers.....	26
Theory of Operation	14	CONFIGURATION1 Register	27
Circuit Information	14	CONFIGURATION2 Register	28
Converter Operation.....	14	ALERT Register	28
Analog Input Structure.....	14	ALERT_LOW_THRESHOLD Register	29
ADC Transfer Function	15	ALERT_HIGH_THRESHOLD Register	29
Applications Information.....	16	Outline Dimensions.....	30
Power Supply	16	Ordering Guide	30
Modes of Operation	18		

REVISION HISTORY

10/2020—Revision 0: Initial Version

SPECIFICATIONS

$V_{CC} = 3.0\text{ V to }3.6\text{ V}$, $V_{LOGIC} = 1.65\text{ V to }3.6\text{ V}$, reference voltage (V_{REF}) = 2.5 V internal, sampling frequency (f_{SAMPLE}) = 1 MSPS for the AD4682, $f_{SAMPLE} = 500\text{ kSPS}$ for the AD4683, $T_A = -40^\circ\text{C to }+125^\circ\text{C}$, and no oversampling enabled, unless otherwise noted. FS is full scale. Multifunction pin names may be referenced by their relevant function only.

Table 2.

Parameter	Test Conditions/Comments	Min	Typ	Max	Unit
RESOLUTION		16			Bits
THROUGHPUT CONVERSION RATE					
AD4682				1	MSPS
AD4683				500	kSPS
DC ACCURACY					
No Missing Codes		16			Bits
Differential Nonlinearity (DNL) Error		-1.0	± 0.5	+1.0	LSB
Integral Nonlinearity (INL) Error		-2.5	± 1	+2.5	LSB
Gain Error	$-40^\circ\text{C to }+125^\circ\text{C}$	-0.06	± 0.02	+0.06	% FS
Gain Error Temperature Drift		-3	± 1	+3	ppm/ $^\circ\text{C}$
Gain Error Match			0.025	+0.07	% FS
Offset Error		-0.5	± 0.05	+0.5	mV
Offset Temperature Drift		-5	± 1	+5	$\mu\text{V}/^\circ\text{C}$
Offset Error Match	$-40^\circ\text{C to }+125^\circ\text{C}$		0.05	+0.5	mV
AC ACCURACY					
Dynamic Range	Input frequency (f_{IN}) = 1 kHz $V_{REF} = 3.3\text{ V external}$		88		dB
			86		dB
Oversampled Dynamic Range	Oversampling ratio (OSR) = $\times 4$		91.8		dB
Signal-to-Noise Ratio (SNR)	$V_{REF} = 3.3\text{ V external}$	85	87.5		dB
		84	86		dB
	OS_MODE = 1, OSR = $\times 8$, RES = 1		93.4		dB
	$f_{IN} = 100\text{ kHz}$		85.3		dB
Spurious-Free Dynamic Range (SFDR)			101		dB
Total Harmonic Distortion (THD)			-100		dB
	$f_{IN} = 100\text{ kHz}$		-97		dB
Signal-to-Noise-and-Distortion (SINAD)	$V_{REF} = 3.3\text{ V external}$	84.5	87		dB
		83.5	85.5		dB
Channel to Channel Isolation			-110		dB
ANALOG INPUT					
Voltage Range	(A_{INX+}) to (A_{INX-})	$-V_{REF}/2$		$+V_{REF}/2$	V
Absolute Input Voltage Range	A_{INX+}	-0.1		$V_{REF} + 0.1$	V
Common-Mode Input Range	A_{INX-}		$V_{REF}/2 \pm 0.075$		V
Common-Mode Rejection Ratio (CMRR)	$f_{IN} = 500\text{ kHz}$		-70		dB
DC Leakage Current			0.1	1	μA
Input Capacitance	When in track mode		18		pF
	When in hold mode		5		pF
SAMPLING DYNAMICS					
Input Bandwidth	At -0.1 dB		6		MHz
	At -3 dB		25		MHz
Aperture Delay			2		ns
Aperture Delay Match			26	100	ps
Aperture Jitter			20		ps

Parameter	Test Conditions/Comments	Min	Typ	Max	Unit
REFERENCE INPUT AND OUTPUT					
V_{REF} Input					
Voltage Range	External reference	2.49		3.4	V
Current	External reference				
AD4682	1 MSPS		0.26	0.29	mA
AD4683	500 kSPS		0.23	0.26	mA
V_{REF} Output Voltage	-40°C to +125°C	2.495	2.5	2.505	V
V_{REF} Temperature Coefficient			5	10	ppm/°C
V_{REF} Noise			7		μ V rms
DIGITAL INPUTS (SCLK, SDI, AND \overline{CS})					
Logic Levels					
Input Voltage					
Low (V_{IL})				$0.2 \times V_{LOGIC}$	V
High (V_{IH})		$0.8 \times V_{LOGIC}$			V
Input Current					
Low (I_{IL})		-1		+1	μ A
High (I_{IH})		-1		+1	μ A
DIGITAL OUTPUTS (SDOA AND SDOB/ALERT)					
Output Coding			Twos complement		Bits
Output Voltage					
Low (V_{OL})	Sink current (I_{SINK}) = 300 μ A			0.4	V
High (V_{OH})	Source current (I_{SOURCE}) = -300 μ A	$V_{LOGIC} - 0.3$			V
Floating State					
Leakage Current				± 1	μ A
Output Capacitance			10		pF
POWER SUPPLIES					
V_{CC}					
		3.0	3.3	3.6	V
	External reference = 3.3 V	3.2	3.3	3.6	V
V_{LOGIC}		1.65		3.6	V
V_{CC} Current (I_{VCC})					
Normal Mode (Operational)	AD4682, 1 MSPS		7.28	8.4	mA
	AD4683, 500 kSPS		4.76	5.6	mA
Normal Mode (Static)			2.3	2.8	mA
Shutdown Mode			101	200	μ A
V_{LOGIC} Current (I_{VLOGIC})					
Normal Mode (Operational)	SDOA and SDOB at 0x1FFF				
	AD4682, 1 MSPS		884	950	μ A
	AD4683, 500 kSPS		438	470	μ A
Normal Mode (Static)			10	200	nA
Shutdown Mode			10	200	nA
Power Dissipation					
Total Power (P_{TOTAL}) (Operational)			83	107	mW
V_{CC} Power (P_{VCC})					
Normal Mode (Operational)	AD4682, 1 MSPS		26.2	30.3	mW
	AD4683, 500 kSPS		17.2	20.2	mW
Normal Mode (Static)			8	11	mW
Shutdown Mode			365	720	μ W
V_{LOGIC} Power (P_{VLOGIC})					
Normal Mode (Operational)	SDOA and SDOB at 0x1FFF				
	AD4682, 1 MSPS		3.2	3.5	mW
	AD4683, 500 kSPS		1.6	1.7	mW
Normal Mode (Static)			36	720	nW
Shutdown Mode			36	720	nW

TIMING SPECIFICATIONS

$V_{CC} = 3.0\text{ V to }3.6\text{ V}$, $V_{LOGIC} = 1.65\text{ V to }3.6\text{ V}$, $V_{REF} = 2.5\text{ V internal}$, and $T_A = -40^\circ\text{C to }+125^\circ\text{C}$, unless otherwise noted. See Figure 2 to Figure 5, Figure 37, Figure 38, and Figure 39 for the timing diagrams. Multifunction pin names may be referenced by their relevant function only.

Table 3.

Parameter	Min	Typ	Max	Unit	Description
t_{CYC}	1			μs	AD4682
	2			μs	AD4683
t_{SCLKED}	190			ns	\overline{CS} falling edge to first SCLK falling edge
t_{SCLK}	25			ns	SCLK period
t_{SCLKH}	10			ns	SCLK high time
t_{SCLKL}	10			ns	SCLK low time
t_{CSH}	10			ns	\overline{CS} pulse width
t_{QUIET}					Interface quiet time prior to conversion
	500			ns	AD4682
t_{SDOEN}	1500			ns	AD4683
					\overline{CS} low to SDOA and SDOB/ \overline{ALERT} enabled
t_{SDOH}			6	ns	$V_{LOGIC} \geq 2.25\text{ V}$
			8	ns	$1.65\text{ V} \leq V_{LOGIC} < 2.3\text{ V}$
t_{SDOS}	3			ns	SCLK rising edge to SDOA and SDOB/ \overline{ALERT} hold time
t_{SDOT}			6	ns	$V_{LOGIC} \geq 2.25\text{ V}$
			8	ns	$1.65\text{ V} \leq V_{LOGIC} < 2.3\text{ V}$
t_{SDIS}			8	ns	\overline{CS} rising edge to SDOA and SDOB/ \overline{ALERT} high impedance
t_{SDIH}	1			ns	SDI setup time prior to SCLK falling edge
t_{SCLKCS}	1			ns	SDI hold time after SCLK falling edge
$t_{CONVERT}$	0		190	ns	SCLK rising edge to \overline{CS} rising edge
$t_{ACQUIRE}$				ns	Conversion time
t_{RESET}	810			ns	Acquire time
	1810			ns	AD4682
$t_{POWERUP}$					AD4683
					Valid time to start conversion after software reset
$t_{REGWRITE}$		250		ns	Valid time to start conversion after soft reset
		800		ns	Valid time to start conversion after hard reset
$t_{STARTUP}$					Supply active to conversion
			5	ms	First conversion allowed
t_{ALERTS}			11	ms	Settled to within 1% with internal reference
			5	ms	Settled to within 1% with external reference
t_{ALERTC}			5	ms	Supply active to register read write access allowed
t_{ALERTS}			11	ms	Exiting shutdown mode to conversion
			10	μs	Settled to within 1% with internal reference
t_{ALERTC}			220	ns	Settled to within 1% with external reference
			12	ns	Time from \overline{CS} to \overline{ALERT} indication
t_{ALERTC}			12	ns	Time from \overline{CS} to \overline{ALERT} clear

Timing Diagrams

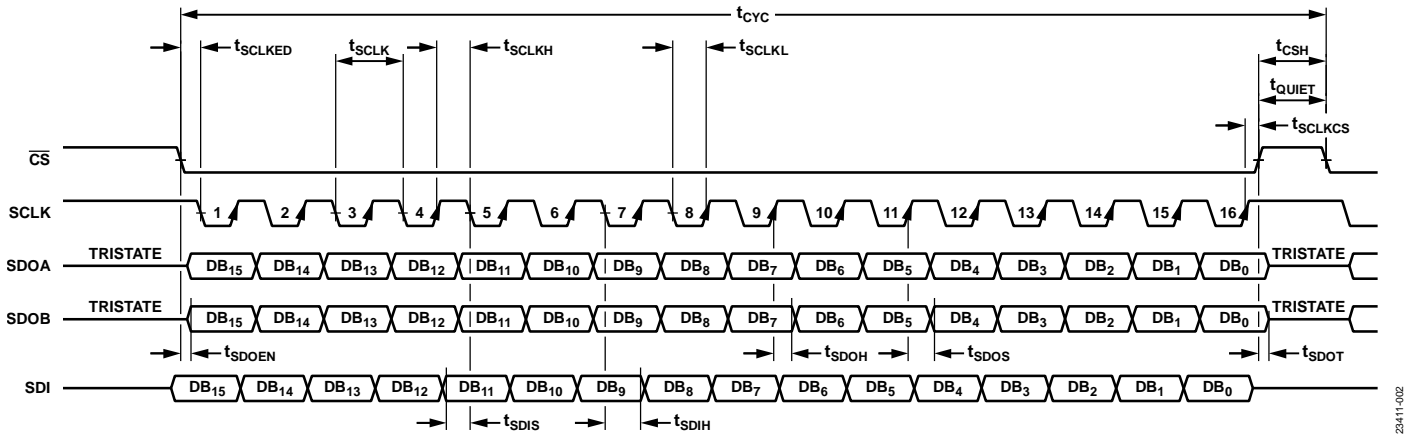

Figure 2. Serial Interface Timing Diagram

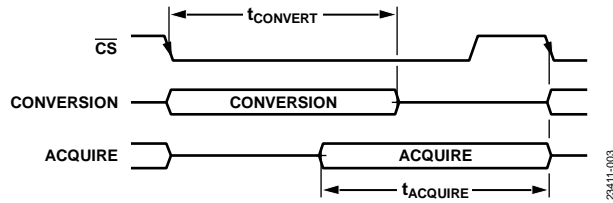

Figure 3. Internal Conversion Acquire Timing

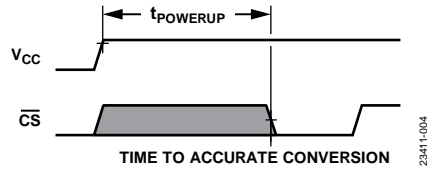

Figure 4. Power-Up Time to Conversion

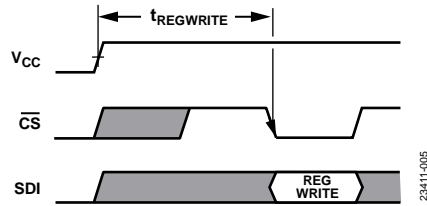

Figure 5. Power-Up Time to Register Read Write Access

ABSOLUTE MAXIMUM RATINGS

Table 4.

Parameter	Rating
V _{CC} to GND	−0.3 V to +4 V
V _{LOGIC} to GND	−0.3 V to +4 V
Input Voltage	
Analog to GND	−0.3 V to V _{REF} + 0.3 V, V _{CC} + 0.3 V, or +4 V (whichever is smaller)
Digital to GND	−0.3 V to V _{LOGIC} + 0.3 V, or +4 V (whichever is smaller)
Digital Output Voltage to GND	−0.3 V to V _{LOGIC} + 0.3 V, or +4 V (whichever is smaller)
REFIO Input to GND	−0.3 V to V _{CC} + 0.3 V
Input Current to Any Pin Except Supplies	±10 mA
Temperature	
Operating Range	−40°C to +125°C
Storage Range	−65°C to +150°C
Junction	150°C
Pb-Free Soldering Reflow	260°C

Stresses at or above those listed under Absolute Maximum Ratings may cause permanent damage to the product. This is a stress rating only; functional operation of the product at these or any other conditions above those indicated in the operational section of this specification is not implied. Operation beyond the maximum operating conditions for extended periods may affect product reliability.

THERMAL RESISTANCE

Thermal performance is directly linked to printed circuit board (PCB) design and operating environment. Careful attention to PCB thermal design is required.

θ_{JA} is the natural convection, junction to ambient thermal resistance measured in a one cubic foot sealed enclosure. θ_{JC} is the junction to case thermal resistance.

Table 5. Thermal Resistance

Package Type	θ_{JA}	θ_{JC}	Unit
CP-16-45 ¹	55.4	12.7	°C/W

¹ Test Condition 1: thermal impedance simulated values are based on JEDEC 252P thermal test board four thermal vias. See JEDEC JESD5-51.

ELECTROSTATIC DISCHARGE (ESD) RATINGS

The following ESD information is provided for handling of ESD-sensitive devices in an ESD protected area only.

Human body model (HBM) per ANSI/ESDA/JEDEC JS-001.

Field induced charge device model (FICDM) per ANSI/ESDA/JEDEC JS-002.

ESD Ratings for AD4682 and AD4683

Table 6. AD4682 and AD4683, 16-Lead LFCSP

ESD Model	Withstand Threshold (V)	Class
HBM	±4000	3A
FICDM	±1250	C3

ESD CAUTION



ESD (electrostatic discharge) sensitive device. Charged devices and circuit boards can discharge without detection. Although this product features patented or proprietary protection circuitry, damage may occur on devices subjected to high energy ESD. Therefore, proper ESD precautions should be taken to avoid performance degradation or loss of functionality.

PIN CONFIGURATION AND FUNCTION DESCRIPTIONS

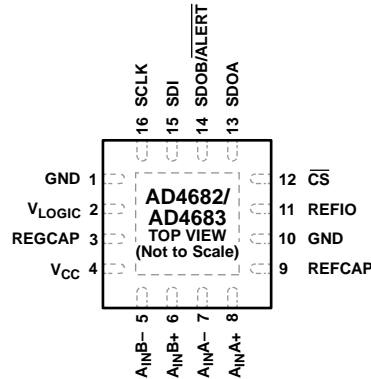

NOTES
1. EXPOSED PAD. FOR PROPER OPERATION OF THE DEVICE, CONNECT THE EXPOSED PAD TO GROUND.

23411-009

Figure 6. Pin Configuration

Table 7. Pin Function Descriptions

Pin No.	Mnemonic	Description
1, 10	GND	Ground Reference Points. The GND pins are the ground reference points for all circuitry on the device.
2	V _{LOGIC}	Logic Interface Supply Voltage, 1.65 V to 3.6 V. Decouple V _{LOGIC} to GND with a 1 μF capacitor.
3	REGCAP	Decoupling Capacitor Pin for Voltage Output from the Internal Regulator. Decouple REGCAP to GND with a 1 μF capacitor. The voltage at REGCAP is 1.9 V typical.
4	V _{CC}	Power Supply Input Voltage, 3.0 V to 3.6 V. Decouple V _{CC} to GND using a 1 μF capacitor.
5, 6	A _{INB-} , A _{INB+}	Analog Inputs of ADC B. The A _{INB-} and A _{INB+} analog inputs form a pseudo differential pair. A _{INB-} is typically connected to V _{REF} /2, and the A _{INB+} voltage range is from 0 V to V _{REF} .
7, 8	A _{INA-} , A _{INA+}	Analog Inputs of ADC A. The A _{INA-} and A _{INA+} analog inputs form a pseudo differential pair. A _{INA-} is typically connected to V _{REF} /2, and the A _{INA+} voltage range is from 0 V to V _{REF} .
9	REFCAP	Decoupling Capacitor Pin for Band Gap Reference. Decouple REFCAP to GND with a 0.1 μF capacitor. The voltage at REFCAP is 2.5 V typical.
11	REFIO	Reference Input and Output. The on-chip reference of 2.5 V is available as an output on REFIO for external use if the device is configured accordingly. Alternatively, an external reference of 2.5 V to 3.3 V can be input to REFIO. Set the REFSEL bit in the CONFIGURATION1 register to 1 when using the external reference, and apply the REFSEL bit after V _{CC} and V _{LOGIC} . Decoupling is required on REFIO for both the internal and external reference options. Apply a 1 μF capacitor from REFIO to GND.
12	$\overline{\text{CS}}$	Chip Select Input. Active low, logic input. $\overline{\text{CS}}$ provides the dual function of initiating conversions on the AD4682 and the AD4683 and framing the serial data transfer.
13	SDOA	Serial Data Output A. SDOA functions as a serial data output pin to access the ADC A or ADC B conversion results or data from any of the on-chip registers.
14	SDOB/ $\overline{\text{ALERT}}$	Serial Data Output B/Alert Indication Output. The SDOB/ $\overline{\text{ALERT}}$ pin can operate as a serial data output pin or an alert indication output. SDOB functions as a serial data output pin to access the ADC B conversion results. $\overline{\text{ALERT}}$ operates as an alert pin going low to indicate that a conversion result exceeded a configured threshold. When using $\overline{\text{ALERT}}$, set the SDO bit in the CONFIGURATION2 register to 1, and set the ALERT_EN bit to 1 in the CONFIGURATION1 register.
15	SDI	Serial Data Input. SDI provides the data written to the on-chip control registers.
16	SCLK	Serial Clock Input. SCLK is for data transfers to and from the ADC.
	EPAD	Exposed Pad. For proper operation of the device, connect the exposed pad to ground.

TYPICAL PERFORMANCE CHARACTERISTICS

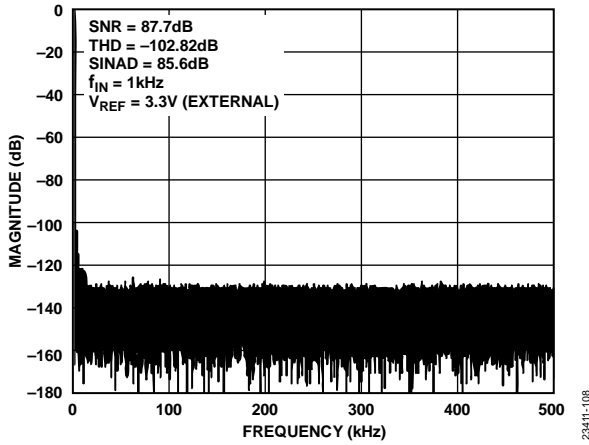

Figure 7. AD4682 Fast Fourier Transform (FFT), $V_{REF} = 3.3\text{ V}$ External

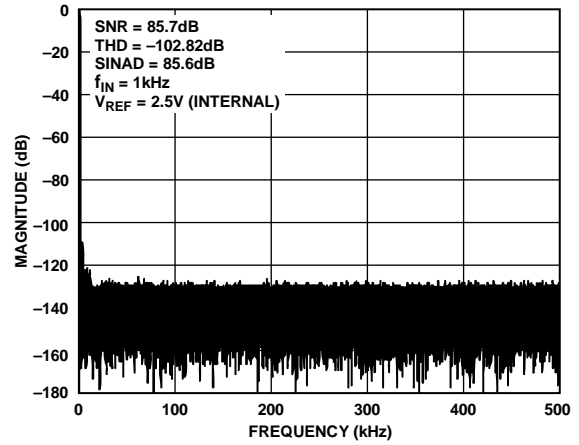

Figure 10. AD4682 FFT, $V_{REF} = 2.5\text{ V}$ Internal

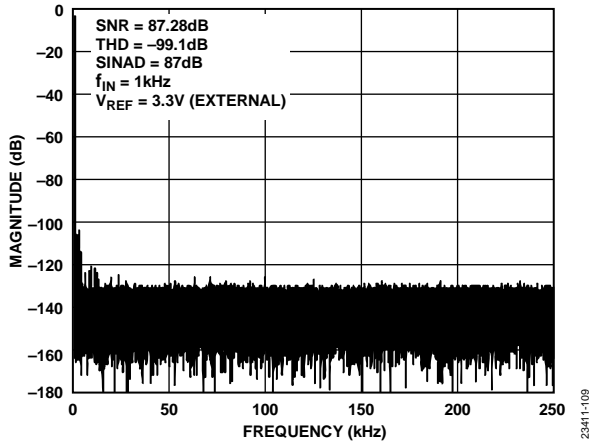

Figure 8. AD4683 FFT, $V_{REF} = 3.3\text{ V}$ External

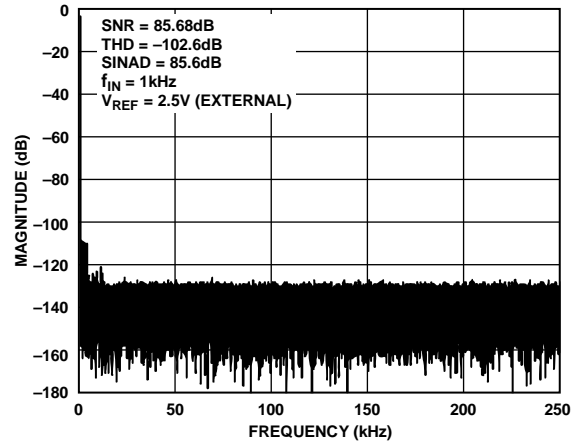

Figure 11. AD4683 FFT, $V_{REF} = 2.5\text{ V}$ External

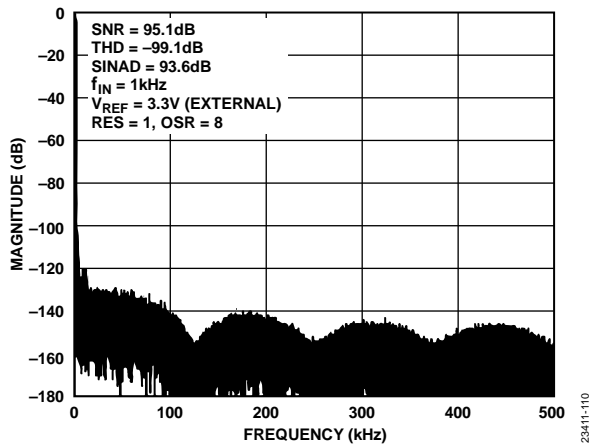

Figure 9. AD4682 FFT, Rolling Average Oversampling

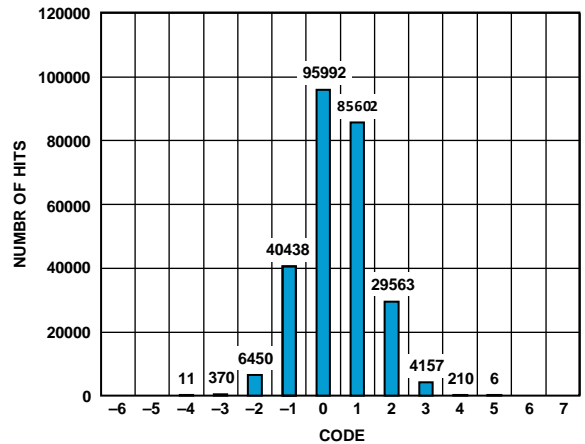

Figure 12. DC Histogram at Code Center

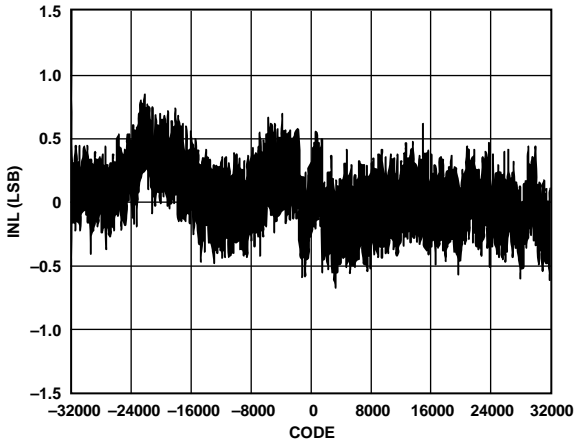

Figure 13. Typical INL Error

23411-114

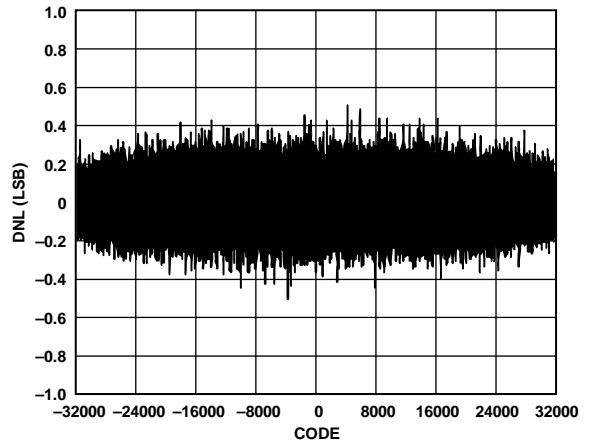

Figure 16. Typical DNL Error

23411-117

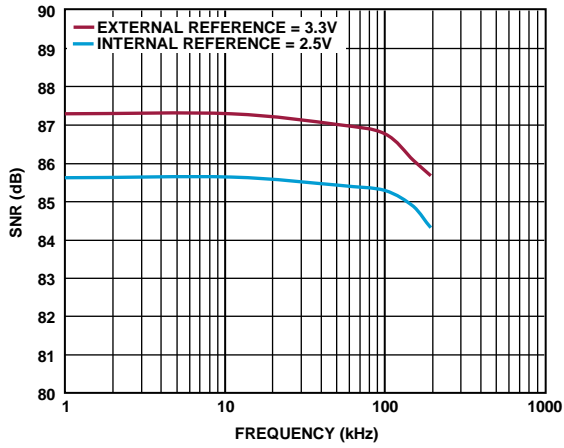

Figure 14. AD4682 SNR vs. Frequency

23411-115

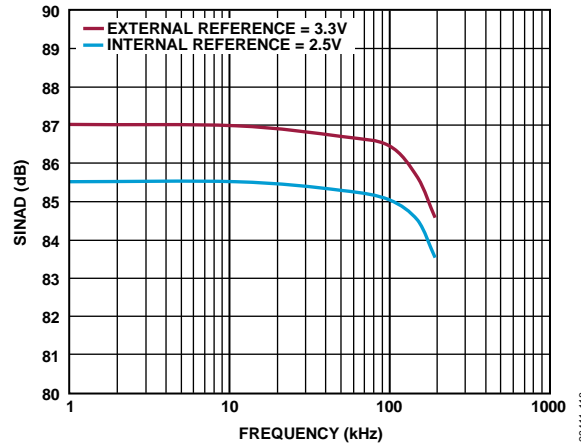

Figure 17. AD4682 SINAD vs. Frequency

23411-118

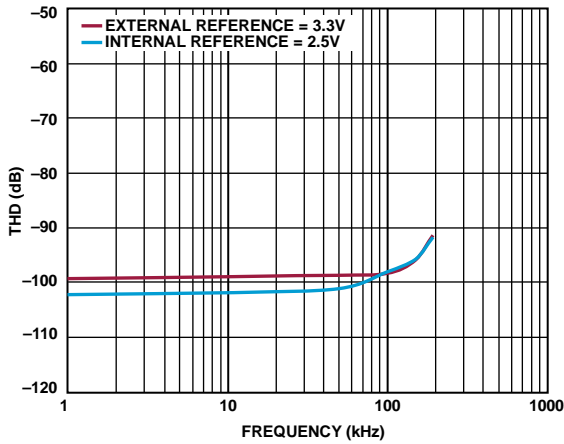

Figure 15. AD4682 THD vs. Frequency

23411-116

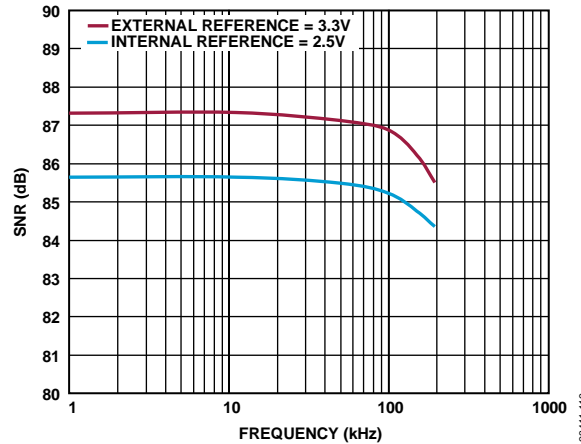

Figure 18. AD4683 SNR vs. Frequency

23411-119

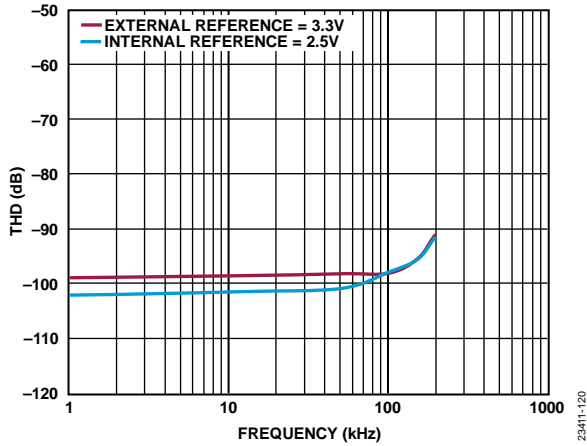

Figure 19. AD4683 THD vs. Frequency

23411-120

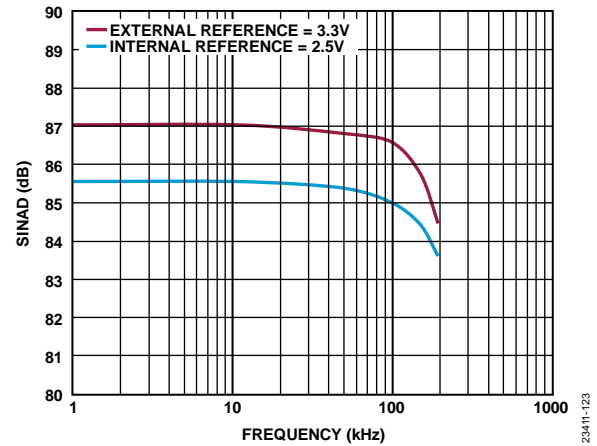

Figure 22. AD4683 SINAD vs. Frequency

23411-123

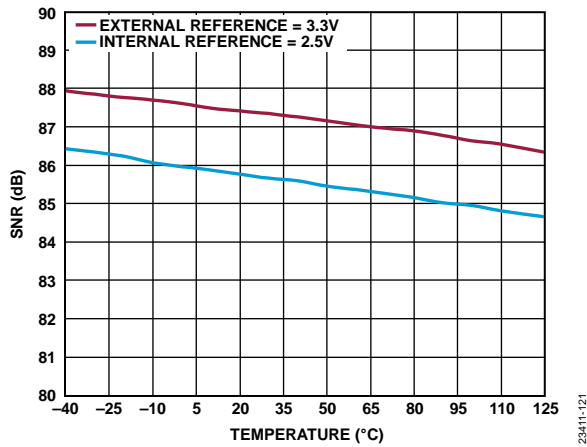

Figure 20. AD4682 SNR vs. Temperature

23411-121

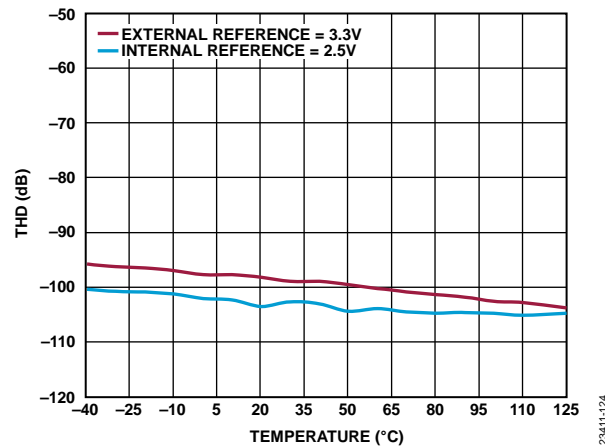

Figure 23. AD4682 THD vs. Temperature

23411-124

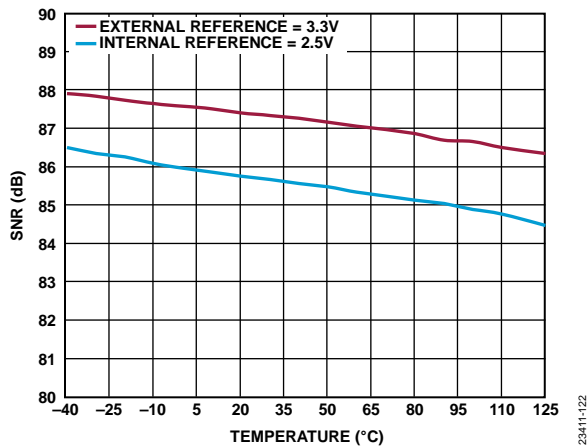

Figure 21. AD4683 SNR vs. Temperature

23411-122

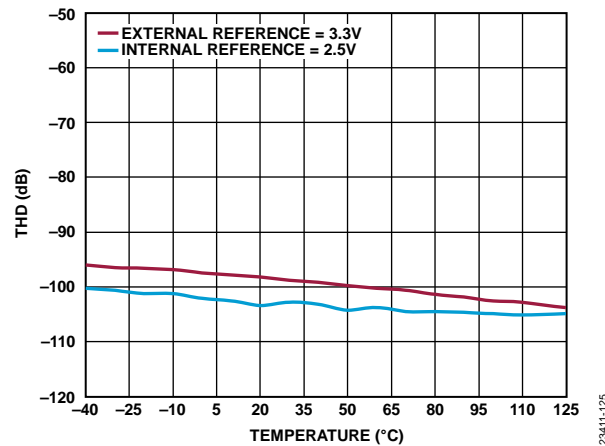

Figure 24. AD4683 THD vs. Temperature

23411-125

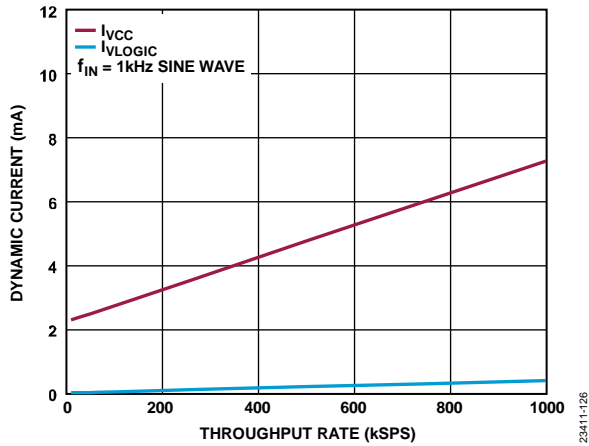

Figure 25. Dynamic Current vs. Throughput Rate

23411-126

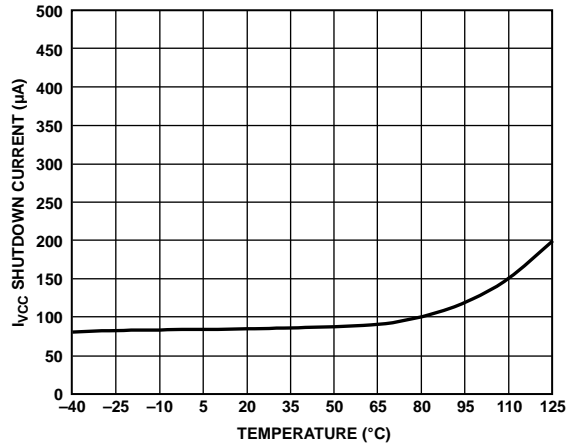

Figure 28. I_VCC Shutdown Current vs. Temperature

23411-129

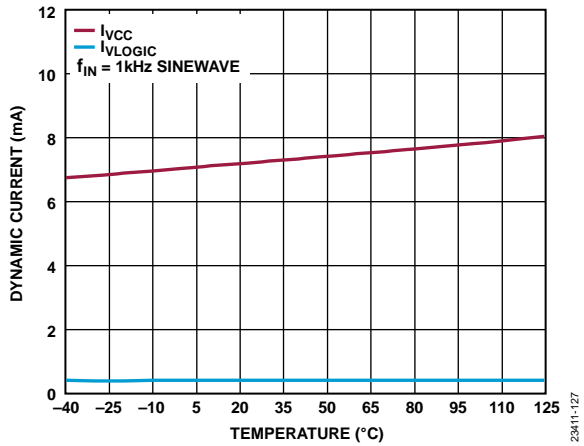

Figure 26. Dynamic Current vs. Temperature

23411-127

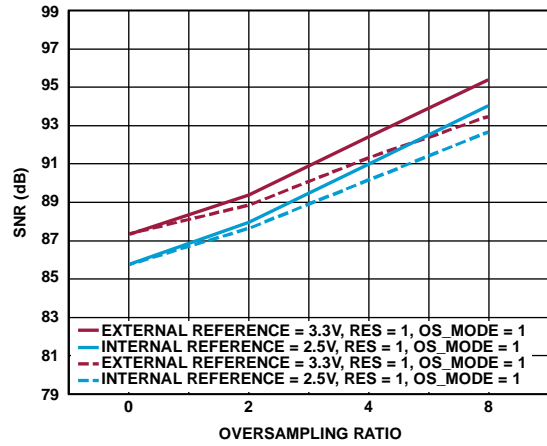

Figure 29. AD4682 SNR vs. Oversampling Ratio, Rolling Average Oversampling

23411-130

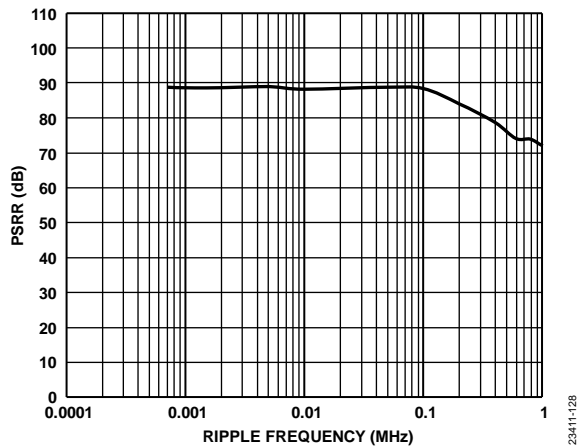

Figure 27. Power Supply Rejection Ratio (PSRR) vs. Ripple Frequency

23411-128

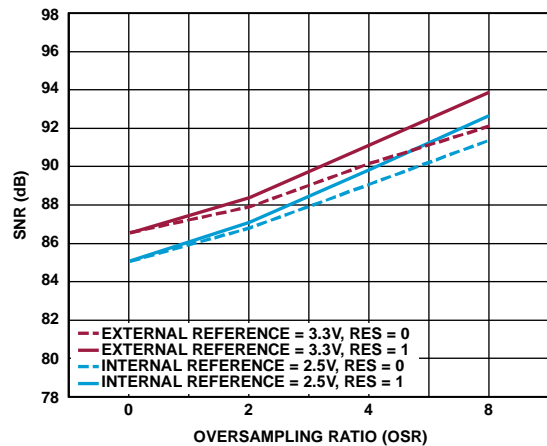

Figure 30. AD4683 SNR vs. Oversampling Ratio, Rolling Average Oversampling

23411-131

TERMINOLOGY

Differential Nonlinearity (DNL)

In an ideal ADC, code transitions are 1 LSB apart. DNL is the maximum deviation from this ideal value. DNL is often specified in terms of resolution for which no missing codes are guaranteed.

Integral Nonlinearity (INL)

INL is the deviation of each individual code from a line drawn from negative full scale through positive full scale. The point used as negative full scale occurs ½ LSB before the first code transition. Positive full scale is defined as a level 1½ LSB beyond the last code transition. The deviation is measured from the middle of each code to the true straight line.

Gain Error

The first transition (from 100 ... 000 to 100 ... 001) occurs at a level ½ LSB above nominal negative full scale. The last transition (from 011 ... 110 to 011 ... 111) occurs for an analog voltage 1½ LSB below the nominal full scale. The gain error is the deviation of the difference between the actual level of the last transition and the actual level of the first transition from the difference between the ideal levels.

Gain Error Temperature Drift

Gain error temperature drift is the gain error change due to a temperature change of 1°C.

Gain Error Match

Gain error matching is the difference in negative full-scale error between the input channels and the difference in positive full-scale error between the input channels.

Offset Error

Offset error is the difference between the ideal midscale voltage, 0 V, and the actual voltage producing the midscale output code, 0 LSB.

Offset Temperature Drift

Offset temperature drift is the zero error change due to a temperature change of 1°C.

Offset Error Match

Offset error match is the difference in zero error between the input channels.

Signal-to-Noise Ratio (SNR)

SNR is the ratio of the rms value of the actual input signal to the rms sum of all other spectral components below the Nyquist frequency, excluding harmonics and dc. The value for SNR is expressed in dB.

Spurious-Free Dynamic Range (SFDR)

SFDR is the difference, in dB, between the rms amplitude of the input signal and the peak spurious signal.

Total Harmonic Distortion (THD)

THD is the ratio of the rms sum of the first five harmonic components to the rms value of a full-scale input signal and is expressed in dB.

Signal-to-Noise-and-Distortion (SINAD)

SINAD is the ratio of the rms value of the actual input signal to the rms sum of all other spectral components that are less than the Nyquist frequency, including harmonics but excluding dc. The value for SINAD is expressed in dB.

Common-Mode Rejection Ratio (CMRR)

CMRR is the ratio of the power in the ADC output at the frequency, f , to the power of a 200 mV p-p sine wave applied to the common-mode voltage of A_{INX+} and A_{INX-} of frequency, f . The value for CMRR is expressed in dB.

$$CMRR = 10\log(P_{ADC_IN}/P_{ADC_OUT})$$

where:

P_{ADC_IN} is the common-mode power at the frequency, f , applied to the A_{INX+} and A_{INX-} inputs.

P_{ADC_OUT} is the power at the frequency, f , in the ADC output.

Aperture Delay

Aperture delay is the measure of the acquisition performance and is the time between the falling edge of the CS input and when the input signal is held for a conversion.

Aperture Delay Match

Aperture delay match is the difference of the aperture delay between ADC A and ADC B.

Aperture Jitter

Aperture jitter is the variation in aperture delay.

THEORY OF OPERATION

CIRCUIT INFORMATION

The AD4682 and the AD4683 are high speed, dual, simultaneous sampling, pseudo differential, 16-bit, SAR ADCs. The AD4682 and the AD4683 operate from a 3.0 V to 3.6 V power supply and feature throughput rates of 1 MSPS and 500 kSPS, respectively.

The AD4682 and the AD4683 contain two SAR ADCs and a serial peripheral interface (SPI) with two separate data output pins. The devices are housed in a 16-lead LFCSP, offering the user considerable space-saving advantages over alternative solutions.

Data is accessed from the devices via the SPI. The SPI can operate with one or two serial outputs. The AD4682 and the AD4683 have an on-chip 2.5 V internal reference, V_{REF} . If an external reference is required, disable the internal reference, supply a reference value that ranges from 2.5 V to 3.3 V, and set the REFSEL bit in the CONFIGURATION1 register to 1. If the internal reference is used elsewhere in the system, buffer the reference output. The pseudo differential analog input range for the AD4682 and the AD4683 is the common-mode voltage (V_{CM}) $\pm V_{REF}/2$.

The AD4682 and the AD4683 feature an on-chip oversampling block to improve performance. Rolling average oversampling mode and power-down options that allow power saving between conversions are also available. Configuration of the devices is implemented via the standard SPI (see the Interface section).

CONVERTER OPERATION

The AD4682 and the AD4683 have two SAR ADCs, each based around two capacitive digital-to-analog converters (DACs). Figure 31 and Figure 32 show the simplified schematics of one of these ADCs in acquisition and conversion phases, respectively. The ADC comprises the control logic, an SAR, and two capacitive DACs. In Figure 31 (the acquisition phase), SW3 is closed, SW1 and SW2 are in Position A, the comparator is held in a balanced condition, and the sampling capacitor (C_S) arrays can acquire the pseudo differential signal on the input.

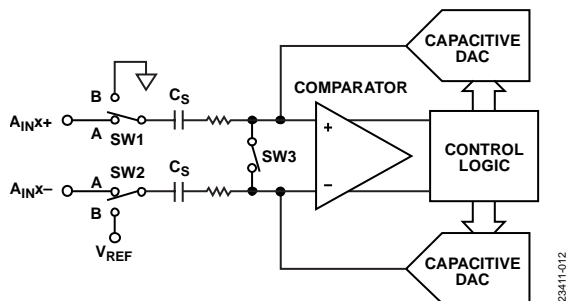

Figure 31. ADC Acquisition Phase

When the ADC starts a conversion (see Figure 32), SW3 opens and SW1 and SW2 move to Position B, causing the comparator to become unbalanced. Both inputs are disconnected when the conversion begins. The control logic and charge redistribution DACs are used to add and subtract fixed amounts of charge

from the sampling capacitor arrays to bring the comparator back into a balanced condition. When the comparator is rebalanced, the conversion completes. The control logic generates the ADC output code. The output impedances of the sources driving the A_{INX+} and A_{INX-} pins must be matched. Otherwise, the two inputs have different settling times, which results in errors.

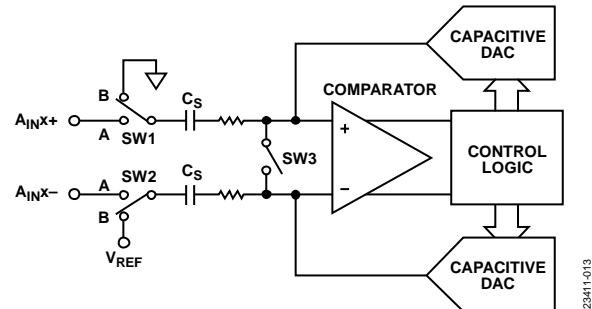

Figure 32. ADC Conversion Phase

ANALOG INPUT STRUCTURE

Figure 33 shows the equivalent analog input circuit of the AD4682 and the AD4683. The four diodes (D) provide ESD protection for the analog inputs. Ensure that the analog input signals do not exceed the supply rails by more than 300 mV. Exceeding the limit causes these diodes to become forward-biased and start conducting into the substrate. These diodes can conduct up to 10 mA without causing irreversible damage to the devices.

The C_1 capacitors in Figure 33 are typically 3 pF and can primarily be attributed to pin capacitance. The R_1 resistors are lumped components made up of the on resistance of the switches. The value of these resistors is typically about 200 Ω . The C_2 capacitors are sampling capacitors of the ADC with a capacitance of 15 pF typically.

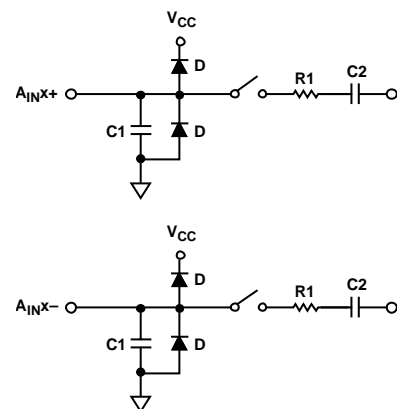

Figure 33. Equivalent Analog Input Circuit, Conversion Phase—Switches Open, Track Phase—Switches Closed

ADC TRANSFER FUNCTION

The AD4682 and the AD4683 can use a typical 2.5 V to 3.3 V V_{REF} . The AD4682 and the AD4683 convert the differential voltage of the analog inputs (A_{INA+} , A_{INA-} , A_{INB+} , and A_{INB-}) into a digital output.

The conversion result is MSB first, twos complement. The LSB size is $V_{REF}/2^N$, where N is the ADC resolution. The ADC resolution is determined by the resolution of the device chosen, and if resolution boost mode is enabled. Table 8 outlines the LSB size expressed in μV for different resolutions and reference voltage options.

The ideal transfer characteristics for the AD4682 and the AD4683 are shown in Figure 34.

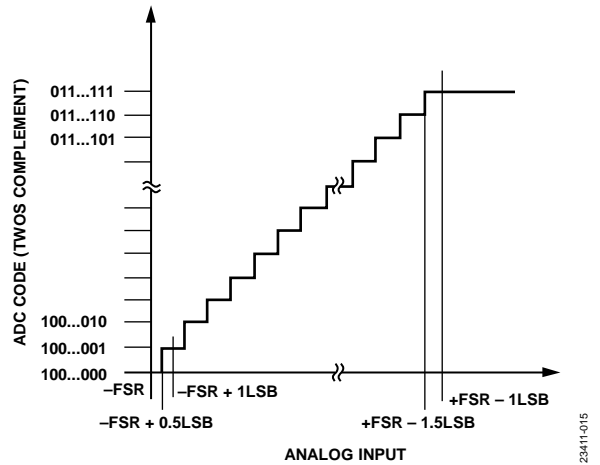

Figure 34. ADC Ideal Transfer Function (FSR = Full-Scale Range)

Table 8. LSB Size

Resolution (Bits)	2.5 V Reference (μV)	3.3 V Reference (μV)
16	38.1	50.3
18	9.5	12.6

APPLICATIONS INFORMATION

Figure 35 shows an example of the typical connection diagram for the AD4682 and the AD4683. Decouple the V_{CC} , V_{LOGIC} , REGCAP, and REFIO pins with suitable decoupling capacitors as shown in Figure 35.

The exposed pad is a ground reference point for circuitry on the devices and must be connected to the PCB ground.

Place a differential RC filter on the analog inputs to ensure optimal performance is achieved.

The performance of the AD4682 and the AD4683 devices can be impacted by noise on the digital interface. This impact is dependent on the on-board layout and design. Keep a minimal distance between the digital line to the digital interface, or place a 100 Ω resistor in series and close to the SDOA pin and the SDOB/ALERT pin to reduce noise from the digital interface coupling of the AD4682 and the AD4683.

The two pseudo differential ADC channels of the AD4682 and the AD4683 can accept an input voltage range from 0 V to V_{REF} on $A_{IN}A+$ and $A_{IN}B+$, and a $V_{REF}/2$ voltage on $A_{IN}A-$ and $A_{IN}B-$. The $A_{IN}A+$, $A_{IN}B+$, $A_{IN}A-$, and $A_{IN}B-$ analog input pins can be driven with an amplifier. Table 9 lists the recommended driver amplifiers that best fit and add value to the application. The AD4682 and the AD4683 have a buffered internal 2.5 V reference that is accessed via the REFIO pin. The buffered internal 2.5 V reference must use an external buffer, like the [ADA4807-2](#), when connecting the reference to the external circuitry. The AD4682 and the AD4683 have an option to use an ultralow noise, high accuracy voltage reference as an external voltage source ranging from 2.5 V to 3.3 V, such as the [ADR4533](#) and [ADR4525](#).

POWER SUPPLY

The typical application circuit in Figure 35 can be powered by a single 5 V voltage source ($V+$) that supplies the entire signal chain. The 5 V supply can come from a low noise, CMOS low dropout (LDO) regulator ([ADP7105](#)). The driver amplifier supply is supplied by the +5 V ($V+$) and -2.5 V negative supply rail ($V-$), which is derived from the inverter ([ADM660](#)). The inverter converts the +5 V to -5 V and supplies the voltage to the [ADP7182](#) low noise voltage regulator to output the -2.5 V. The two independent supplies of the AD4682 and the AD4683, V_{CC} and V_{LOGIC} , that supply the analog circuitry and digital interface, respectively, can be supplied by a low quiescent current LDO regulator, such as the [ADP166](#). The ADP166 is a suitable supply with a fixed output voltage range from 1.2 V to 3.3 V for typical V_{CC} and V_{LOGIC} levels. Decouple both the V_{CC} supply and the V_{LOGIC} supply separately with a 1 μ F capacitor. Additionally, an internal LDO regulator supplies the AD4682 and the AD4683. The on-chip regulator provides a 1.9 V supply for internal use on the device only. Decouple the REGCAP pin with a 1 μ F capacitor connected to GND.

Power-Up

The AD4682 and the AD4683 are not easily damaged by power supply sequencing. V_{CC} and V_{LOGIC} can be applied in any sequence. Apply an external reference after V_{CC} and V_{LOGIC} are applied.

The AD4682 and the AD4683 require a $t_{POWERUP}$ time from applying V_{CC} and V_{LOGIC} until the ADC conversion results are stable. Applying \overline{CS} pulses or interfacing with the AD4682 and the AD4683 prior to the setup time elapsing does not have a negative impact on ADC operation. Conversion results are not guaranteed to meet data sheet specifications during this time, however, and must be ignored.

Table 9. Signal Chain Components

Companion Parts	Part Name	Description	Typical Application
ADC Driver	ADA4896-2	1 nV/ $\sqrt{\text{Hz}}$, rail-to-rail output amplifier	Precision, low noise, high frequency
	ADA4940-2	Ultra low power, full differential, low distortion	Precision, low density, low power
	ADA4807-2	1 mA, rail-to-rail output amplifier	Precision, low power, high frequency
	LTC6227	1 nV/ $\sqrt{\text{Hz}}$, 420 MHz gain bandwidth product (GBW), rail-to-rail output amplifier	Precision, low noise, high frequency
External Reference	ADR4525	Ultralow noise, high accuracy 2.5 V voltage reference	2.5 V reference voltage
	ADR4533	Ultralow noise, high accuracy 3.3 V voltage reference	3.3 V reference voltage
LDO	ADP166	Very low quiescent, 150 mA, LDO regulator	3.0 V to 3.6 V supply for V_{CC} and V_{LOGIC}

MODES OF OPERATION

The AD4682 and the AD4683 have several on-chip configuration registers for controlling the operational mode of the device.

Multifunction pin names may be referenced by their relevant function only.

OVERSAMPLING

Oversampling is a common method used in analog electronics to improve the accuracy of the ADC result. Multiple samples of the analog input are captured and averaged to reduce the noise component from the quantization noise and the thermal noise (kTC) of the ADC. The AD4682 and the AD4683 offer an oversampling function on chip, rolling average oversampling.

The rolling average oversampling functionality is enabled by writing a 1 on the OS_MODE bit, Bit 9, and a valid nonzero value on the OSR bits, Bits[8:6], in the CONFIGURATION1 register. Oversampling is disabled by writing a 0 on the OS_MODE bit, Bit 9, and a zero value on the OSR bits, Bits[8:6], of the CONFIGURATION1 register.

Rolling Average Oversampling

Rolling average oversampling mode can be used in applications where higher output data rates are required and where higher SNR or dynamic range is required. Rolling average oversampling involves taking a number of samples, adding the samples together, and dividing the result by the number of samples taken. This result is then output from the AD4682 or the AD4683. The sample data is not cleared after the process completes. The rolling average oversampling mode uses a first in, first out (FIFO) buffer of the most recent samples in the averaging calculation, allowing the ADC throughput rate and output data rate to stay the same.

Rolling average oversampling mode is enabled by setting the OS_MODE bit to Logic 1 and having a valid nonzero value in the OSR bits. The oversampling ratio of the digital filter is

controlled using the oversampling bits, OSR (see Table 10). The output result is decimated to 16-bit resolution for the AD4682 and the AD4683. If additional resolution is required, configure the resolution boost bit in the CONFIGURATION1 register. See the Resolution Boost section for further details.

In rolling average oversampling mode, all ADC conversions are controlled and initiated by the falling edge of \overline{CS} . After a conversion is complete, the result is loaded into the FIFO. The FIFO length is 8, regardless of the oversampling ratio set. The FIFO is filled on the first conversion after a power-on reset, the first conversion after a software controlled hard or soft reset, or the first conversion after the REFSEL bit is toggled. A new conversion result is shifted into the FIFO on completion of every ADC conversion, regardless of the status of the OSR bits and the OS_MODE bit. This conversion allows a seamless transition from no oversampling to rolling average oversampling or different rolling average oversampling ratios without waiting for the FIFO to fill.

The number of samples, n , defined by the OSR bits are taken from the FIFO, added together, and the result is divided by n . The time between \overline{CS} falling edges is the cycle time, which can be controlled by the user, depending on the required data output rate.

RESOLUTION BOOST

The default conversion result output data size for the AD4682 and the AD4683 is 16 bits. When the on-chip oversampling function is enabled, the performance of the ADC can exceed the 16-bit level. To accommodate the performance boost achievable, it is possible to enable an additional two bits of resolution. If the RES bit in the CONFIGURATION1 register is set to Logic 1, and the AD4682 and the AD4683 are in a valid oversampling mode, the conversion result size for the AD4682 and the AD4683 is 18 bits. In this mode, 18 SCLKs are required to propagate the data.

Table 10. AD4682 Rolling Average Oversampling Performance Overview

OSR, Bits[8:6]	Oversampling Ratio	SNR (dB Typical)				Output Data Rate (kSPS Maximum)
		V _{REF} = 2.5 V		V _{REF} = 3.3 V		
		RES = 0	RES = 1	RES = 0	RES = 1	
000	Disabled	85.7	85.7	87.3	87.3	1000
001	2	87.6	87.9	88.8	89.3	1000
010	4	90.1	90.9	91.3	92.4	1000
011	8	92.6	94.0	93.4	95.4	1000

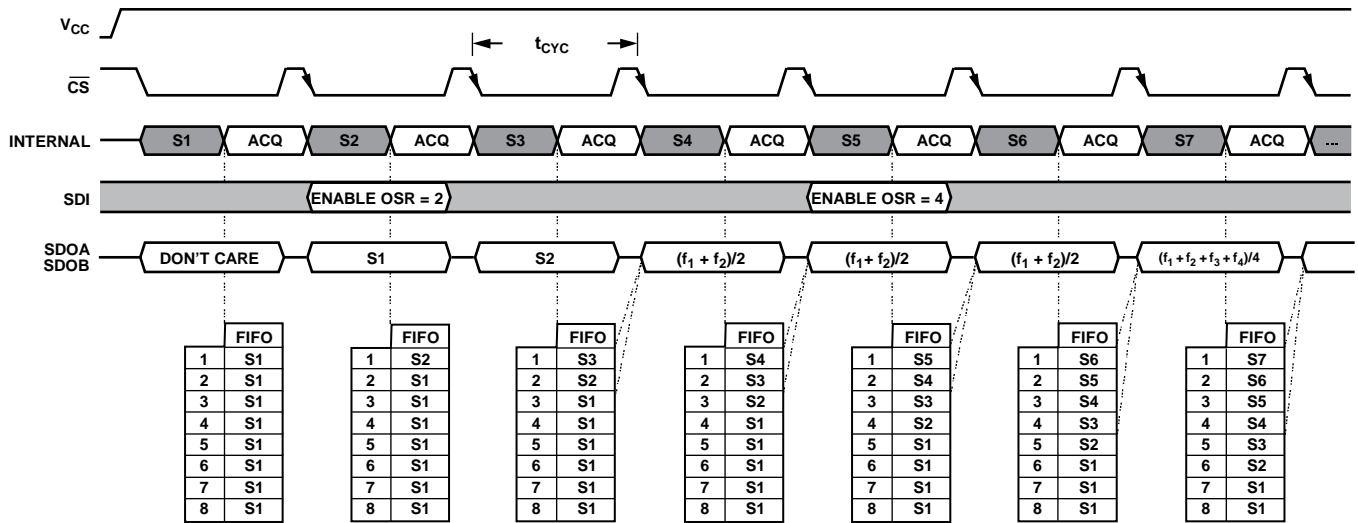

Figure 36. Rolling Average Oversampling Mode Configuration

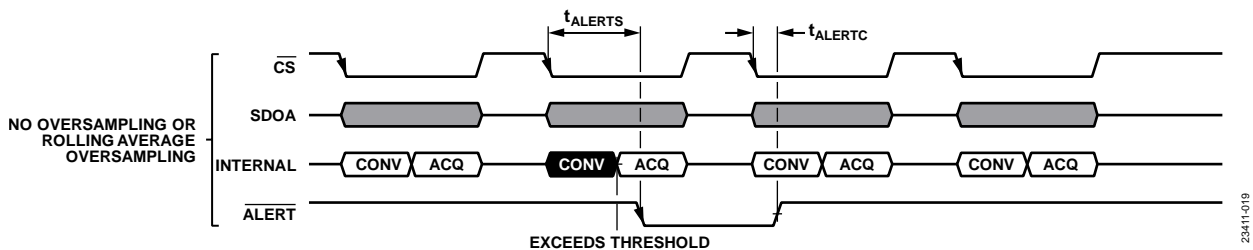

Figure 37. Alert Operation

ALERT

The alert functionality is an out of range indicator and can be used as an early indicator of an out of bounds conversion result. An alert event triggers when the conversion result value register exceeds the alert high limit value in the ALERT_HIGH_THRESHOLD register or falls below the alert low limit value in the ALERT_LOW_THRESHOLD register. The ALERT_HIGH_THRESHOLD register and ALERT_LOW_THRESHOLD register are common to all ADCs. When setting the threshold limits, the alert high threshold must always be greater than the alert low threshold. Detailed alert information is accessible in the ALERT register.

The ALERT register contains two status bits per ADC, one corresponding to the high limit, and the other to the low limit. A logical OR of alert signals for all ADCs creates a common alert value. This value can be configured to drive out on the ALERT function of the SDOB/ALERT pin. The SDOB/ALERT pin is configured as ALERT by configuring the following bits in the CONFIGURATION1 and CONFIGURATION2 registers:

- Set the SDO bit to 1.
- Set the ALERT_EN bit to 1.
- Set a valid value to the ALERT_HIGH_THRESHOLD register and the ALERT_LOW_THRESHOLD register.

The alert indication function is available in rolling average oversampling and nonoversampling modes.

The ALERT function of the SDOB/ALERT pin is updated at the end of the conversion. The alert indication status bits in the ALERT register are updated as well and must be read before the end of the next conversion. The ALERT function of the SDOB/ALERT pin is cleared with a falling edge of CS. Issuing a software reset also clears the alert status in the ALERT register.

POWER MODES

The AD4682 and the AD4683 have two power modes, normal and shutdown. These modes of operation provide flexible power management options, allowing optimization of the power dissipation and throughput rate ratio for different application requirements.

Program the PMODE bit in the CONFIGURATION1 register to configure the power modes in the AD4682 and the AD4683. Set the PMODE bit to Logic 0 for normal mode and Logic 1 for shutdown mode.

Normal Mode

Keep the AD4682 and the AD4683 in normal mode to achieve the fastest throughput rate. All blocks within the AD4682 and the AD4683 remain fully powered at all times, and an ADC conversion can be initiated by a falling edge of CS, when required. When the AD4682 and the AD4683 are not converting, the devices are in static mode and power consumption is automatically reduced. Additional current is required to perform a conversion. Therefore, power consumption on the AD4682 and the AD4683 scales with throughput.

Shutdown Mode

When slower throughput rates and lower power consumption are required, use shutdown mode by either powering down the ADC between each conversion, or by performing a series of conversions at a high throughput rate and then powering down the ADC for a relatively long duration between these burst conversions. When the AD4682 and the AD4683 are in shutdown mode, all analog circuitry powers down, including the internal reference, if enabled. The SPI remains active during shutdown mode to allow the AD4682 and the AD4683 to exit shutdown mode.

To enter shutdown mode, write to the PMODE bit in the CONFIGURATION1 register. The AD4682 and the AD4683 shut down, and current consumption reduces.

To exit shutdown mode and return to normal mode, set the PMODE bit in the CONFIGURATION1 register to Logic 0. All register configuration settings remain unchanged entering or exiting shutdown mode. After exiting shutdown mode, allow sufficient time for the circuitry to turn on before starting a conversion. If the internal reference is enabled, allow the reference to settle for accurate conversions to happen.

INTERNAL AND EXTERNAL REFERENCE

The AD4682 and the AD4683 have a buffered 2.5 V internal reference primarily used as a reference voltage for device operation. When using the buffered internal 2.5 V reference externally via the REFIO pin, the reference must use an external buffer before connecting to the external circuitry. Alternatively, if a more accurate reference or higher dynamic range is required, an external reference can be supplied. An externally supplied reference voltage can range from 2.5 V to 3.3 V.

Reference selection, internal or external, is configured by the REFSEL bit in the CONFIGURATION1 register. If the REFSEL

bit is set to 0, the internal reference buffer is enabled. If the REFSEL bit is set to 1, the internal reference buffer is disabled. If an external reference is preferred, set the REFSEL bit to 1 and supply an external reference to the REFIO pin.

SOFTWARE RESET

The AD4682 and the AD4683 have two reset modes, a soft reset and a hard reset. To initiate a reset, write to the reset bits, Bits[7:0], in the CONFIGURATION2 register.

A soft reset maintains the contents of the configurable registers but refreshes the interface and the ADC blocks. Any internal state machines are reinitialized, and the oversampling block and FIFO are flushed. The ALERT register is then cleared. The reference and LDO regulator remain powered.

A hard reset, in addition to the blocks reset by a soft reset, resets all user registers to default status, resets the reference buffer, and resets the internal oscillator block.

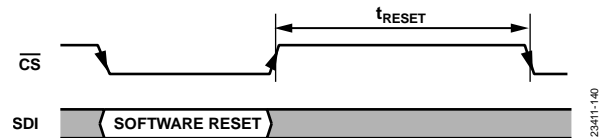

Figure 38. Software Reset Operation

DIAGNOSTIC SELF TEST

The AD4682 and the AD4683 run a diagnostic self test after a power-on reset (POR) or after a software hard reset to ensure the proper configuration is loaded into the device.

The result of the self test is displayed in the SETUP_F bit in the ALERT register. If the SETUP_F bit is set to Logic 1, the diagnostic self test fails. If the self test fails, perform a software hard reset to reset the AD4682 and the AD4683 registers to the default status.

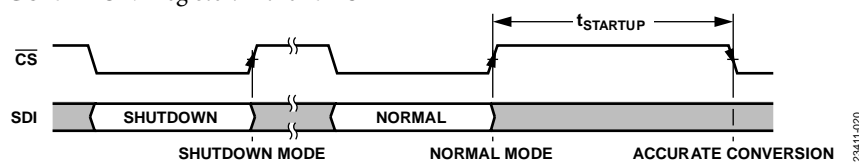

Figure 39. Shutdown Mode Operation

INTERFACE

The interface to the AD4682 and the AD4683 is via an SPI. The interface consists of the \overline{CS} , SCLK, SDOA, SDOB/ALERT, and SDI pins. Multifunction pin names may be referenced by their relevant function only.

The \overline{CS} signal frames a serial data transfer and initiates an ADC conversion process. The falling edge of \overline{CS} puts the track-and-hold into hold mode, at which point the analog input is sampled, and the bus is taken out of three-state.

The SCLK signal synchronizes data in and out of the devices via the SDOA, SDOB, and SDI signals. A minimum of 16 SCLKs are required for a write to or read from a register. The minimum number of SCLKs for a conversion read is dependent on the resolution of the devices and the configuration settings (see Table 11).

The ADC conversion operation is driven internally by an on-board oscillator and is independent of the SCLK signal.

The AD4682 and the AD4683 have two serial output signals, SDOA and SDOB. To achieve the highest throughput of the devices, use both SDOA and SDOB, 2-wire mode, to read conversion results. If a reduced throughput is required or oversampling is used, it is possible to use 1-wire mode, SDOA signal only, for reading conversion results. Programming the SDO bit in the CONFIGURATION2 register configures 2-wire mode or 1-wire mode.

Configuring a cyclic redundancy check (CRC) operation for SPI reads or SPI writes alters the operation of the interface. Consult the relevant CRC Read, CRC Write, and CRC Polynomial sections to ensure proper operation.

READING CONVERSION RESULTS

The \overline{CS} signal initiates the conversion process. A high to low transition on the \overline{CS} signal initiates a simultaneous conversion of both ADCs, ADC A and ADC B. The AD4682 and the AD4683 have a one-cycle readback latency. Therefore, the

conversion results are available on the next SPI access. Take the \overline{CS} signal low, and the conversion result clocks out on the serial output pins. The next conversion also initiates at this point.

The conversion result shifts out of the device as a 16-bit result for the AD4682 and the AD4683. The MSB of the conversion result shifts out on the \overline{CS} falling edge. The remaining data shifts out of the device under the control of the SCLK input. The data shifts out on the rising edge of the SCLK, and the data bits are valid on both the falling edge and the rising edge. After the final SCLK falling edge, take \overline{CS} high again to return the SDOA and SDOB/ALERT pins to a high impedance state.

The number of SCLK cycles to propagate the conversion results on the SDOA and SDOB/ALERT pins is dependent on the serial mode of operation configured and if resolution boost mode is enabled (see Figure 40 and Table 11 for details). If CRC reading is enabled, this reading requires additional SCLK pulses to propagate the CRC information (see the CRC section for more details).

As the \overline{CS} signal initiates a conversion and frames the data, any data access must be completed within a single frame.

Table 11. Number of SCLK Cycles, n, Required for Reading Conversion Results

Interface Configuration	Resolution Boost Mode	CRC Read	SCLK Cycles
2-Wire	Disabled	Disabled	16
		Enabled	24
	Enabled	Disabled	18
		Enabled	26
1-Wire	Disabled	Disabled	32
		Enabled	40
	Enabled	Disabled	36
		Enabled	44

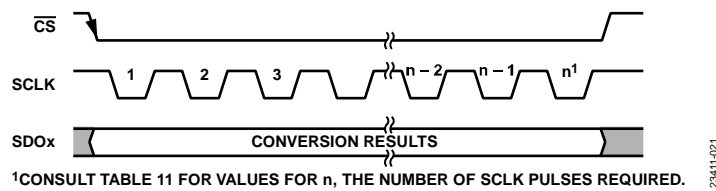

Figure 40. Reading Conversion Results

Serial 2-Wire Mode

Configure 2-wire mode by setting the SDO bit in the CONFIGURATION1 register to 0. In 2-wire mode, the conversion result for ADC A is output on the SDOA pin, and the conversion result for ADC B is output on the SDOB/ALERT pin (see Figure 41).

Serial 1-Wire Mode

In applications where slower throughput rates are allowed, the SPI can be configured to operate in 1-wire mode. In 1-wire mode, the conversion results from ADC A and ADC B are output on the serial output, SDOA. Additional SCLK cycles are required to

propagate all of the data. The ADC A data is output first, followed by the ADC B conversion results (see Figure 42).

LOW LATENCY READBACK

The interface on the AD4682 and the AD4683 has a one cycle latency, as shown in Figure 43. For applications that operate at lower throughput rates, the latency of reading the conversion result can be reduced. When the conversion time elapses, a second CS pulse after the initial CS pulse that initiates the conversion can readback the conversion result. This operation is shown in Figure 43.

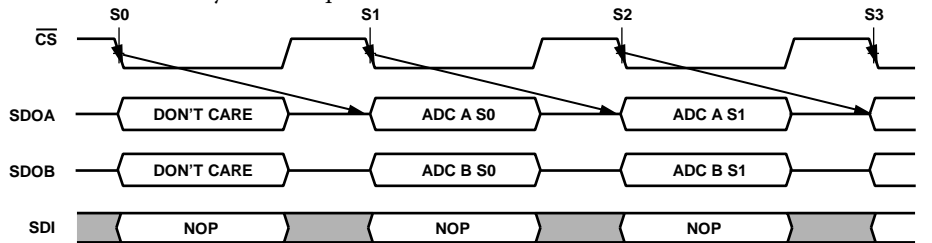

Figure 41. Reading Conversion Results: 2-Wire Mode

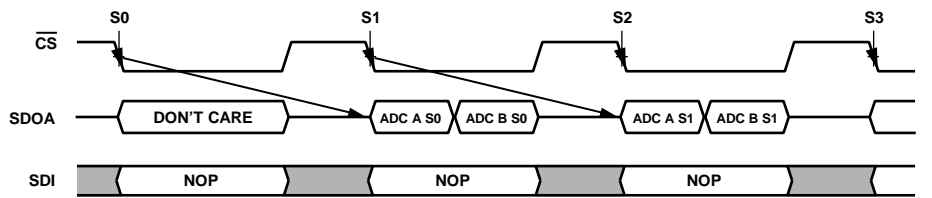

Figure 42. Reading Conversion Results: 1-Wire Mode

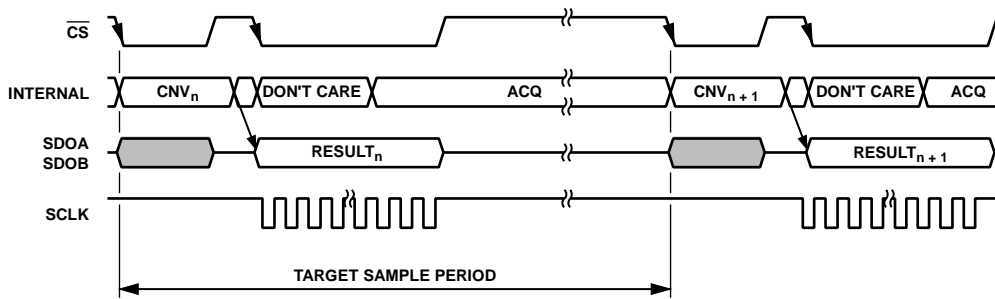

Figure 43. Low Throughput Low Latency

READING FROM DEVICE REGISTERS

All of the registers in the AD4682 and the AD4683 can be read over the SPI. To perform a register read, issue a register read command followed by an additional SPI command that can be either a valid command or a no operation (NOP) command. The format for a read command is shown in Table 14. Set Bit D15 to 0 to select a read command. Bits[D14:D12] contain the register address, and the subsequent 12 bits, Bits[D11:D0], are ignored.

WRITING TO DEVICE REGISTERS

All of the read and write registers in the AD4682 and the AD4683 can be written to over the SPI. The length of an SPI write access is determined by the CRC write function. An SPI access is 16 bits if CRC write is disabled and 24 bits when CRC write is enabled. The format for a write command is shown in Table 14. Set Bit D15 to 1 to select a write command. Bits[D14:D12] contain the register address, and the subsequent 12 bits, Bits[D11:D0], contain the data to be written to the selected register.

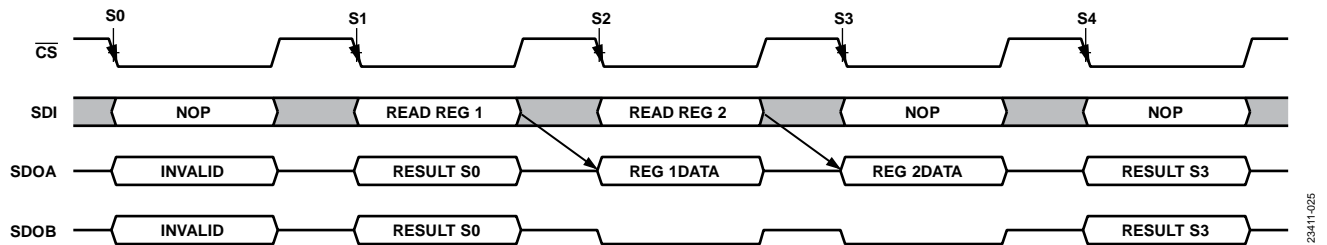

Figure 44. Register Read

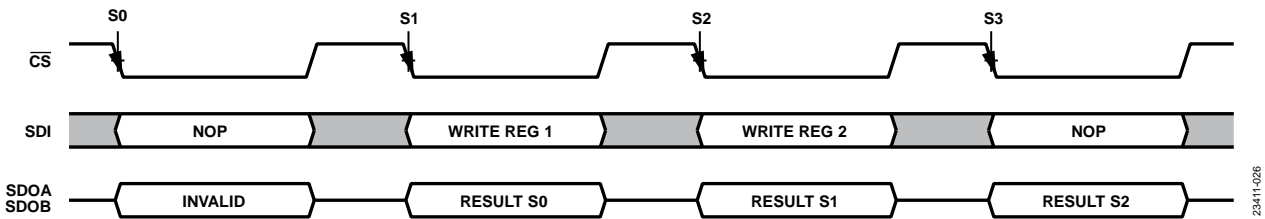

Figure 45. Register Write

CRC

The AD4682 and the AD4683 have CRC checksum modes that can improve interface robustness by detecting errors in data transmissions. The CRC feature is independently selectable for SPI reads and SPI writes. For example, the CRC function for SPI writes can be enabled to prevent unexpected changes to the device configuration but disabled on SPI reads, therefore maintaining a higher throughput rate. The CRC feature is controlled by the programming of the CRC_W bit and CRC_R bits in the CONFIGURATION1 register.

CRC Read

If enabled, a CRC is appended to the conversion result or register reads and consists of an 8-bit word. The CRC is calculated in the conversion result for ADC A and ADC B and is output on SDOA. A CRC is also calculated and appended to register read outputs.

The CRC read function can be used in 2-wire SPI mode, 1-wire SPI mode, and resolution boost mode.

CRC Write

To enable the CRC write function, set the CRC_W bit in the CONFIGURATION1 register to 1. To set the CRC_W bit to 1 to enable the CRC feature, ensure the request frame has a valid CRC appended to the frame.

After the CRC feature is enabled, all register write requests are ignored unless the requests are accompanied by a valid CRC command, requiring a valid CRC to both enable and disable the CRC write feature.

CRC Polynomial

For CRC checksum calculations, the following polynomial is always used: $x^8 + x^2 + x + 1$.

The following is an example of how to generate the checksum on a conversion read. The 16-bit data conversion result of the two channels is combined to produce 32-bit data. The 8 MSBs of the 32-bit data are inverted and then left shifted by eight bits to create a number ending in eight logic zeros. The polynomial is aligned such that its MSB is adjacent to the leftmost Logic 1 of the data. An exclusive OR (XOR) function is applied to the data to produce a new, shorter number. The polynomial is again aligned such that its MSB is adjacent to the leftmost Logic 1 of the new result, and the procedure is repeated. This process repeats until the original data is reduced to a value less than the polynomial, which is the 8-bit checksum. For example, this polynomial is 100000111.

Let the original data of two channels be 0xAAAA and 0x5555, that is, 1010 1010 1010 1010 and 0101 0101 0101 0101. The data of the two channels is then appended, including eight zeros on the right. The data then becomes 1010 1010 1010 1010 0101 0101 0101 0000 0000.

Table 12 shows the CRC calculation of 16-bit two-channel data. In the final XOR operation, the reduced data is less than the polynomial. Therefore, the remainder is the CRC for the assumed data.

REGISTERS

The AD4682 and the AD4683 have user programmable on-chip registers for configuring the device.

Table 13 shows a complete overview of the registers available on the AD4682 and the AD4683. The registers are either read and write (R/W) or read only (R). Any read request to a write only register is ignored, and any write request to a read only register is ignored.

Writes to any other register address are considered an NOP and are ignored. Any read request to a register address, other than those listed in Table 13, is considered an NOP, and the data transmitted in the next SPI frame are the conversion results.

Table 13. Register Summary

Address	Register Name	Bits	Bit 15	Bit 14	Bit 13	Bit 12	Bit 11	Bit 10	Bit 9	Bit 8	Reset	R/W	
			Bit 7	Bit 6	Bit 5	Bit 4	Bit 3	Bit 2	Bit 1	Bit 0			
0x1	CONFIGURATION1	[15:8]	ADDRESSING				RESERVED		OS_MODE	OSR[2]	0x0000	R/W	
		[7:0]	OSR[1:0]	CRC_W	CRC_R	ALERT_EN	RES	REFSEL	PMODE				
0x2	CONFIGURATION2	[15:8]	ADDRESSING				RESERVED			SDO	0x0000	R/W	
		[7:0]	RESET										
0x3	ALERT	[15:8]	ADDRESSING				RESERVED		CRCW_F	SETUP_F	0x0000	R	
		[7:0]	RESERVED	AL_B_HIGH	AL_B_LOW	RESERVED		AL_A_HIGH	AL_A_LOW				
0x4	ALERT_LOW_THRESHOLD	[15:8]	ADDRESSING				ALERT_LOW[11:8]					0x0800	R/W
		[7:0]	ALERT_LOW[7:0]										
0x5	ALERT_HIGH_THRESHOLD	[15:8]	ADDRESSING				ALERT_HIGH[11:8]					0x07FF	R/W
		[7:0]	ALERT_HIGH[7:0]										

ADDRESSING REGISTERS

A serial register transfer on the AD4682 and the AD4683 consists of 16 SCLK cycles. The 4 MSBs written to the AD4682 and the AD4683 are decoded to determine which register is addressed. The 4 MSBs consist of the register address (REGADDR), Bits[D14:D12], and the read and write bit (WR), Bit D15. The register address bits determine which on-chip register is selected. The WR bit determines if the remaining 12 bits of data on the SDI input are loaded into the addressed register, if the addressed register is a valid write register. If the WR bit is 1, the bits load into the register addressed by the register select bits. If the WR bit is 0, the command is seen as a read request. The addressed register data is available to be read during the next read operation.

Table 14. Addressing Register Format

MSB															LSB	
D15	D14	D13	D12	D11	D10	D9	D8	D7	D6	D5	D4	D3	D2	D1	D0	
WR	REGADDR			DATA												

Table 15. Bit Descriptions for Addressing Registers

Bit	Mnemonic	Description
D15	WR	If a 1 is written to the WR bit, Bits[D11:D0] of this register are written to the register specified by REGADDR, if the register is a valid address. Alternatively, if a 0 is written, the next data sent out on the SDOA pin is a read from the designated register, if the register is a valid address.
D14 to D12	REGADDR	When WR = 1, the contents of REGADDR determine the register for selection as outlined in Table 13. When WR = 0 and REGADDR contains a valid register address, the contents on the requested register are output on the SDOA pin during the next interface access. When WR = 0 and REGADDR contains 0x0, 0x6, or 0x7, the contents on the SDI line are ignored. The next interface access results in the conversion results being read back.
D11 to D0	DATA	The data bits are written into the corresponding register specified by the REGADDR data bits when WR is equal to 1 and the REGADDR data bits contain a valid address.

CONFIGURATION1 REGISTER

Address: 0x1, Reset: 0x0000, Name: CONFIGURATION1

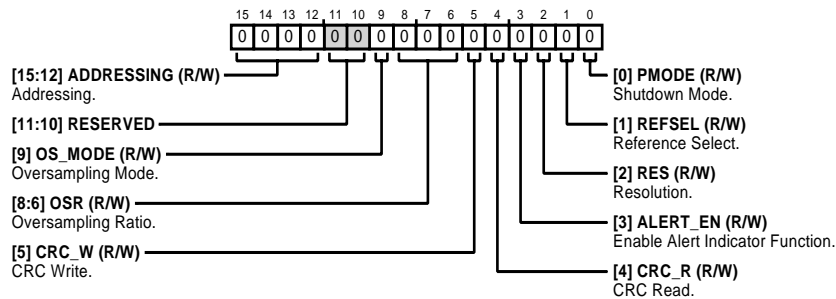
**Table 16. Bit Descriptions for CONFIGURATION1**

Bits	Bit Name	Description	Reset	Access
[15:12]	ADDRESSING	Addressing. Bits[15:12] define the address of the relevant register. See the Addressing Registers section for further details.	0x0	R/W
[11:10]	RESERVED	Reserved.	0x0	R
9	OS_MODE	Oversampling Mode. Enables the rolling average oversampling mode of the ADC. 0: disable. 1: enable.	0x0	R/W
[8:6]	OSR	Oversampling Ratio. Sets the oversampling ratio for all the ADCs in rolling average oversampling mode. Rolling average oversampling mode supports oversampling ratios of $\times 2$, $\times 4$, and $\times 8$. 000: disabled. 001: $\times 2$. 010: $\times 4$. 011: $\times 8$. 100: disabled. 101: disabled. 110: disabled. 111: disabled.	0x0	R/W
5	CRC_W	CRC Write. Controls the CRC functionality for the SDI interface. When setting the CRC_W bit from a 0 to a 1, follow the command with a valid CRC to set this configuration bit. If a valid CRC is not received, the entire frame is ignored. If the CRC_W bit is set to 1, the bit requires a CRC to clear it to 0. 0: no CRC function. 1: CRC function.	0x0	R/W
4	CRC_R	CRC Read. Controls the CRC functionality for the SDOA and SDOB/ALERT interface. 0: no CRC function. 1: CRC function.	0x0	R/W
3	ALERT_EN	Enable Alert Indicator Function. This alert function is enabled when the SDO bit = 1. Otherwise, the ALERT_EN bit is ignored. 0: SDOB. 1: ALERT.	0x0	R/W
2	RES	Resolution. Sets the size of the conversion result data. If OSR = 0, the RES bit is ignored, and the resolution is set to default resolution. 0: normal resolution. 1: 2-bit higher resolution.	0x0	R/W
1	REFSEL	Reference Select. Selects the ADC reference source. 0: selects internal reference. 1: selects external reference.	0x0	R/W
0	PMODE	Shutdown Mode. Sets the power modes. 0: normal mode. 1: shutdown mode.	0x0	R/W

CONFIGURATION2 REGISTER

Address: 0x2, Reset: 0x0000, Name: CONFIGURATION2

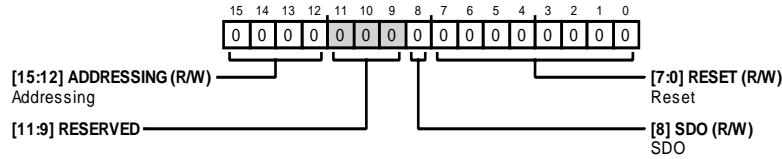

Table 17. Bit Descriptions for CONFIGURATION2

Bits	Bit Name	Description	Reset	Access
[15:12]	ADDRESSING	Addressing. Bits[15:12] define the address of the relevant register. See the Addressing Registers section for further details.	0x0	R/W
[11:9]	RESERVED	Reserved.	0x0	R
8	SDO	SDO. Conversion results in the serial data output. 0: 2-wire. Conversion data are output on both the SDOA and SDOB/ALERT pins. 1: 1-wire. Conversion data are output on the SDOA pin only.	0x0	R/W
[7:0]	RESET	Reset. 0x3C performs a soft reset that resets some blocks. Register contents remain unchanged. Clears the ALERT register and flushes any oversampling stored variables or any active state machines. 0xFF performs a hard reset that resets all possible blocks in the AD4682 or the AD4683. Register contents are set to defaults. All other values are ignored.	0x0	R/W

ALERT REGISTER

Address: 0x3, Reset: 0x0000, Name: ALERT

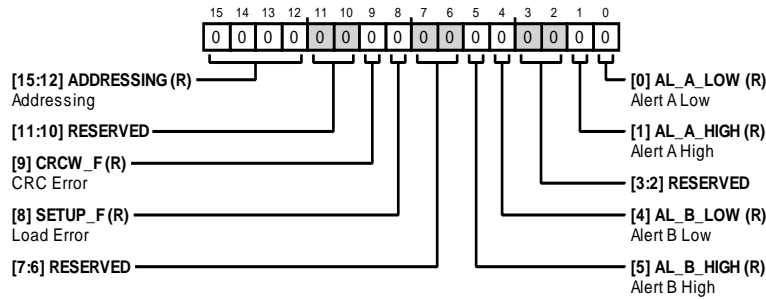

Table 18. Bit Descriptions for ALERT

Bits	Bit Name	Description	Reset	Access
[15:12]	ADDRESSING	Addressing. Bits[15:12] define the address of the relevant register. See the Addressing Registers section for further details.	0x0	R
[11:10]	RESERVED	Reserved.	0x0	R
9	CRCW_F	CRC Error. Indicates that a register write command failed due to a CRC error. This fault bit is sticky and remains set until the register is read. 0: no CRC error. 1: CRC error.	0x0	R
8	SETUP_F	Load Error. The SETUP_F bit indicates that the device configuration data did not load properly on startup. The SETUP_F bit does not clear on an ALERT register read. A hard reset via the CONFIGURATION2 register is required to clear the SETUP_F bit and restart the device setup again. 0: no setup error. 1: setup error.	0x0	R
[7:6]	RESERVED	Reserved.	0x0	R

Bits	Bit Name	Description	Reset	Access
5	AL_B_HIGH	Alert B High. The alert indication high bits indicate if a conversion result for the respective input channel exceeds the value set in the ALERT_HIGH_THRESHOLD register. This fault bit is sticky and remains set until the register is read. 1: alert indication. 0: no alert indication.	0x0	R
4	AL_B_LOW	Alert B Low. The alert indication low bits indicate if a conversion result for the respective input channel exceeds the value set in the ALERT_LOW_THRESHOLD register. This fault bit is sticky and remains set until the register is read. 1: alert indication. 0: no alert indication.	0x0	R
[3:2]	RESERVED	Reserved.	0x0	R
1	AL_A_HIGH	Alert A High. The alert indication high bits indicate if a conversion result for the respective input channel exceeds the value set in the ALERT_HIGH_THRESHOLD register. This fault bit is sticky and remains set until the register is read. 0: no alert indication. 1: alert indication.	0x0	R
0	AL_A_LOW	Alert A Low. The alert indication low bits indicate if a conversion result for the respective input channel exceeds the value set in the ALERT_LOW_THRESHOLD register. This fault bit is sticky and remains set until the register is read. 1: alert indication. 0: no alert indication.	0x0	R

ALERT_LOW_THRESHOLD REGISTER

Address: 0x4, Reset: 0x0800, Name: ALERT_LOW_THRESHOLD

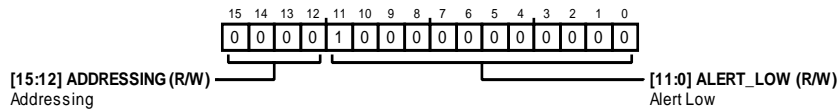

Table 19. Bit Descriptions for ALERT_LOW_THRESHOLD

Bits	Bit Name	Description	Reset	Access
[15:12]	ADDRESSING	Addressing. Bits[15:12] define the address of the relevant register. See the Addressing Registers section for further details.	0x0	R/W
[11:0]	ALERT_LOW	Alert Low. Bits[D11:D0] from ALERT_LOW move to the MSBs of the internal alert low register, Bits[D15:D4]. The remaining bits, Bits[D3:D0], are fixed at 0x0, which sets an alert when the converter result is below ALERT_LOW_THRESHOLD and disables when the converter result is above ALERT_LOW_THRESHOLD.	0x800	R/W

ALERT_HIGH_THRESHOLD REGISTER

Address: 0x5, Reset: 0x07FF, Name: ALERT_HIGH_THRESHOLD

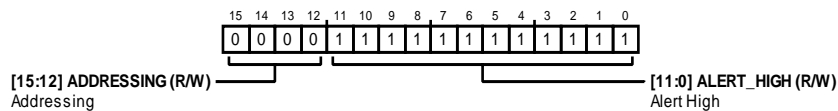
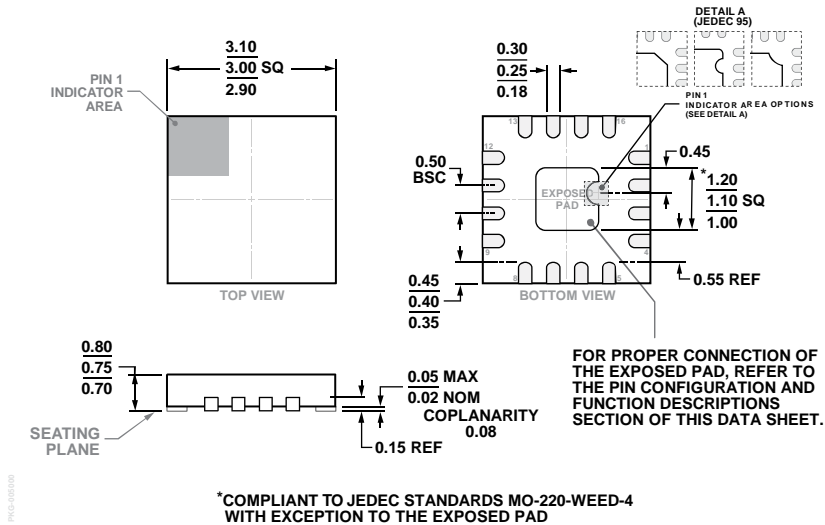

Table 20. Bit Descriptions for ALERT_HIGH_THRESHOLD

Bits	Bit Name	Description	Reset	Access
[15:12]	ADDRESSING	Addressing. Bits[15:12] define the address of the relevant register. See the Addressing Registers section for further details.	0x0	R/W
[11:0]	ALERT_HIGH	Alert High. Bits[D11:D0] from ALERT_HIGH move to the MSBs of the internal alert high register, Bits[D15:D4]. The remaining bits, Bits[D3:D0], are fixed at 0xF, which sets an alert when the converter result is above ALERT_HIGH_THRESHOLD and disables when the converter result is below ALERT_HIGH_THRESHOLD.	0x7FF	R/W

OUTLINE DIMENSIONS



*COMPLIANT TO JEDEC STANDARDS MO-220-WEED-4 WITH EXCEPTION TO THE EXPOSED PAD
 Figure 47. 16-Lead Lead Frame Chip Scale Package [LFCSP]
 3 mm × 3 mm Body and 0.75 mm Package Height
 (CP-16-45)
 Dimensions shown in millimeters

ORDERING GUIDE

Model ^{1,2}	Resolution	Throughput Rate	Temperature Range	Package Description	Package Option	Marking Code
AD4682BCPZ-RL	16-Bit	1 MSPS	-40°C to +125°C	16-Lead LFCSP	CP-16-45	CAN
AD4682BCPZ-RL7	16-Bit	1 MSPS	-40°C to +125°C	16-Lead LFCSP	CP-16-45	CAN
AD4683BCPZ-RL	16-Bit	500 kSPS	-40°C to +125°C	16-Lead LFCSP	CP-16-45	CAP
AD4683BCPZ-RL7	16-Bit	500 kSPS	-40°C to +125°C	16-Lead LFCSP	CP-16-45	CAP
EVAL-AD7383FMCZ				AD7383 Evaluation Board		

¹ Z = RoHS Compliant Part.

² Use the EVAL-AD7383FMCZ to evaluate the AD4682 and the AD4683.