

# Distinctive Characteristics

Carefully designed light diffusion and filtering system produce bright, full surface illumination with front panel relamping.

Spot illumination available in single and bicolor LEDs.

Choice of super bright LEDs in white, green, and blue in addition to standard or bright red, amber, and green LEDs.

Stainless steel clips provide secure mounting with a wide range of panel thicknesses.

Latchdown feature gives indication of circuit status. Audible and tactile feedback with smooth and responsive operation.

Snap-action contact mechanism gives long electrical life and sensitivity of actuation.

Combination solder lug and .110" quick connect terminals are epoxy sealed to prevent entry of flux, dust and other contaminants.

Panel sealed model meets IP65 of IEC529 specifications (similar to NEMA 4 & 13).

Compact switch design minimizes behind panel depth.

Nonilluminated models available and shown in the Pushbutton section.

Matching indicators available and shown in the Indicator section.

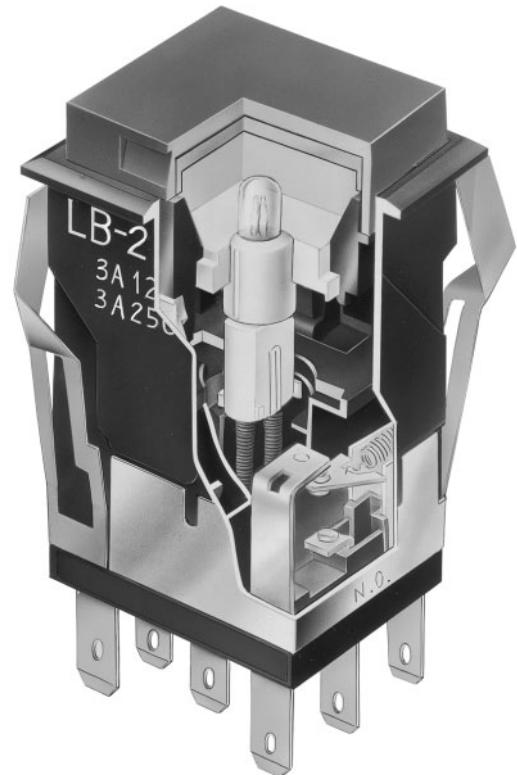

Actual Size

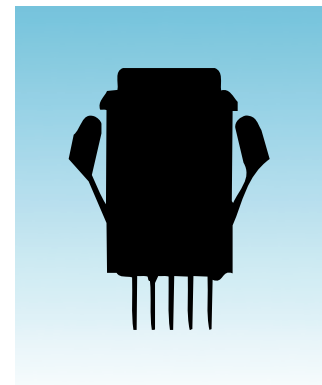

# General Specifications

## Electrical Capacity (Resistive Load)

**Power Level (silver):** 3A @ 125V AC or 3A @ 250V AC or 3A @ 30V DC

**Logic Level (gold):** 0.4VA maximum @ 28V AC/DC maximum

Note: See Supplement Index (page Z1) to find explanation of operating range.

## Other Ratings

<b>Contact Resistance:</b>	50 milliohms maximum for silver; 100 milliohms maximum for gold
<b>Insulation Resistance:</b>	200 megohms minimum @ 500V DC
<b>Dielectric Strength:</b>	1,000V AC minimum between contacts for 1 minute minimum; 1,500V AC minimum between contacts & case for 1 minute minimum
<b>Mechanical Life:</b>	1,000,000 operations minimum for momentary circuit 200,000 operations minimum for maintained circuit
<b>Electrical Life:</b>	100,000 operations minimum
<b>Nominal Operating Force:</b>	450 grams
<b>Contact Timing:</b>	Nonshorting (break-before-make)
<b>Travel for Momentary Circuit:</b>	1.5mm (.059") pretravel; 1.5mm (.059") overtravel; 3.0mm (.118") total travel
<b>Travel for Maintained Circuit:</b>	2.2mm (.087") pretravel; 0.8mm (.031") overtravel; 3.0mm (.118") total travel

## Materials & Finishes

<b>Housing:</b>	Glass fiber reinforced polyamide
<b>Snap-in Frame:</b>	Stainless steel
<b>Movable Contact:</b>	Silver alloy or copper with gold plating
<b>Stationary Contacts:</b>	Silver alloy or copper with gold plating
<b>Base:</b>	Diallyl phthalate
<b>Switch Terminals:</b>	Phosphor bronze with silver or gold plating
<b>Lamp Terminals:</b>	Brass with silver plating



## Environmental Data

<b>Operating Temp Range:</b>	-25°C through +50°C (-13°F through +122°F) Note: When used with a polyvinyl chloride splash cover, the lowest limit is 0°C (32°F)
<b>Humidity:</b>	90 ~ 95% humidity for 96 hours @ 40°C (104°F)
<b>Vibration:</b>	10 ~ 55Hz with peak-to-peak amplitude of 1.5mm traversing the frequency range & returning in 1 minute; 3 right angled directions for 2 hours
<b>Shock:</b>	50G (490m/s <sup>2</sup> ) acceleration (tested in 6 right angled directions, with 5 shocks in each direction)
<b>Sealing:</b>	Not available for snap-in; see next section for panel seal.

## Installation

<b>Cap Installation Force:</b>	3.92N (.88 lbf) maximum downward force on cap
<b>Quick Connect Force:</b>	52.95N (11.9 lbf) maximum downward force on connector
<b>Soldering Time &amp; Temperature:</b>	3 seconds @ 350°C or 5 seconds @ 270°C
<b>Process Seal:</b>	Not available

## Standards & Certifications

<b>Flammability Standards:</b>	UL94V-0 base
 <b>UL Recognized:</b>	All models recognized at 3A @ 125V or 250V AC or 0.4A @ 28V DC maximum; UL File No. WOYR2.E44145; add "/U" to end of part number to order UL mark on switch.
 <b>CSA Certified:</b>	All models certified at 3A @ 125V or 250V AC or 0.4VA @ 28V maximum; CSA File Nos. 023535-0-000; add "/C" to end of part number to order CSA mark on switch.

TYPICAL SWITCH ORDERING EXAMPLE

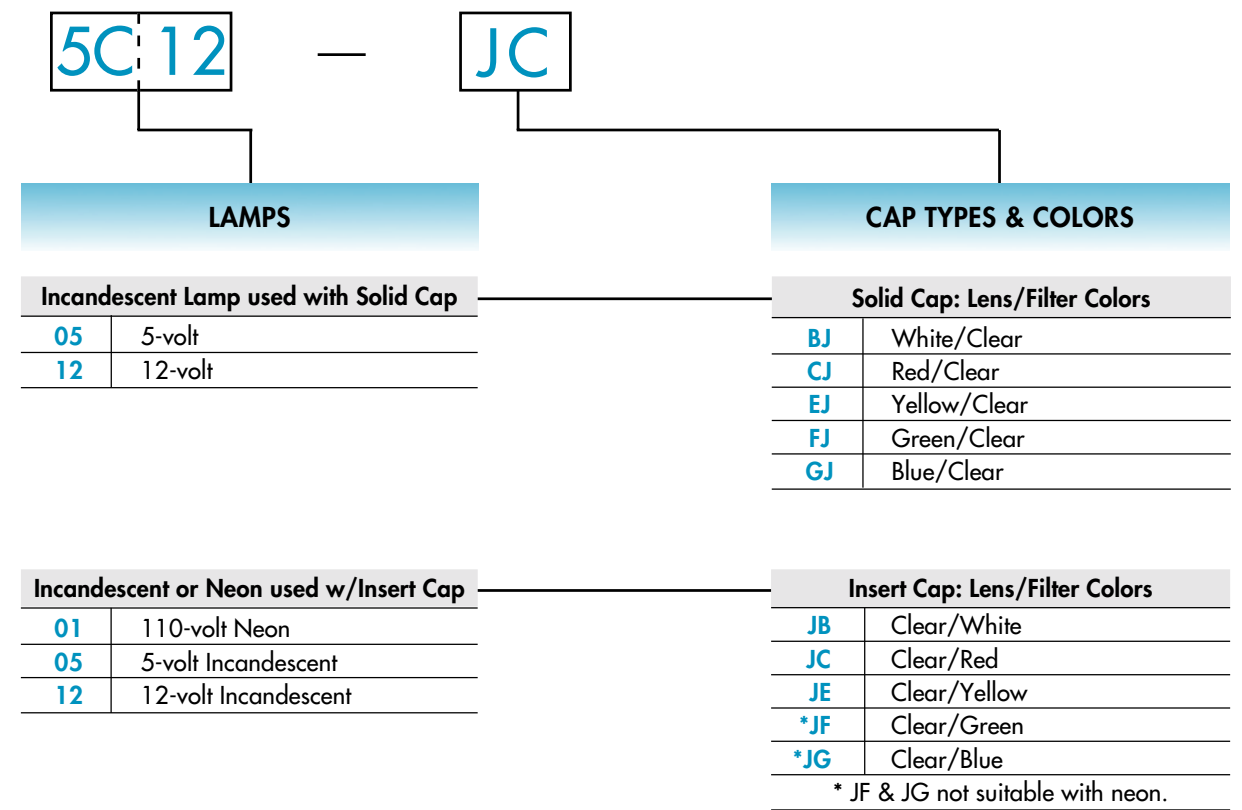
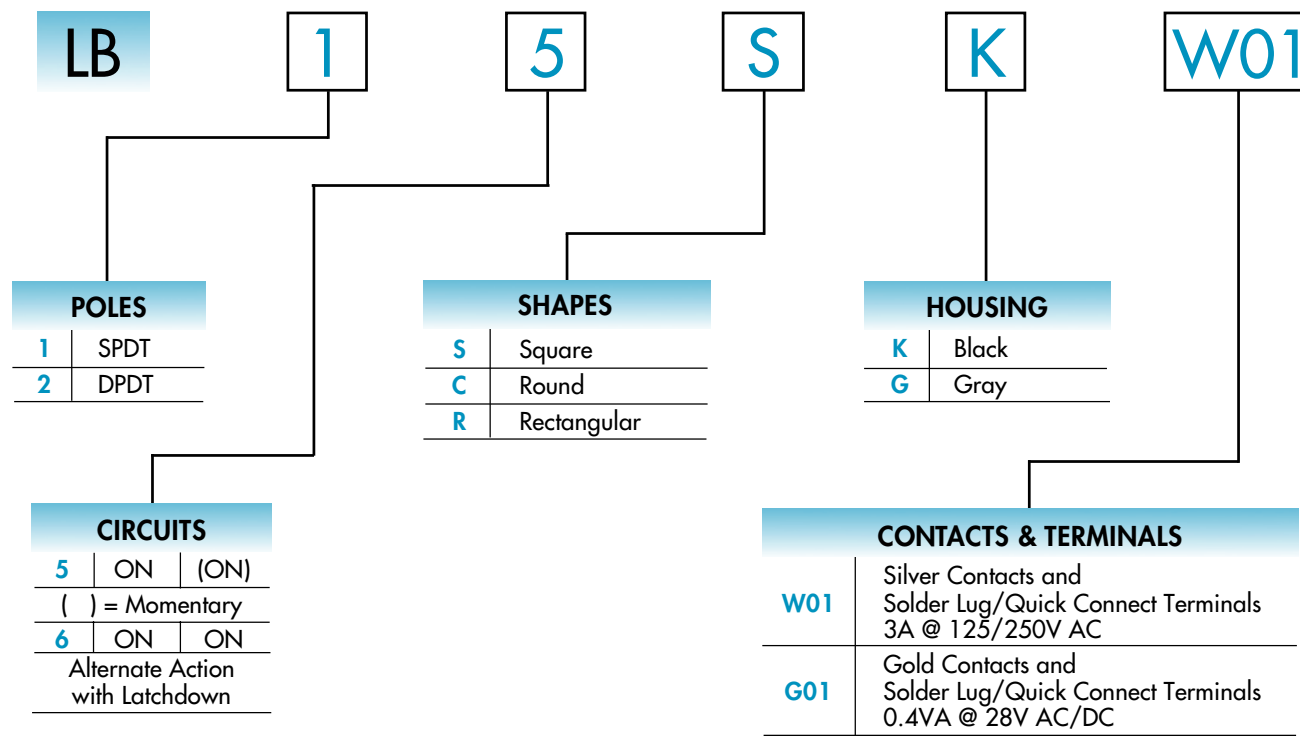

DESCRIPTION FOR TYPICAL ORDERING EXAMPLE

LB15SKW01-5C12-JC

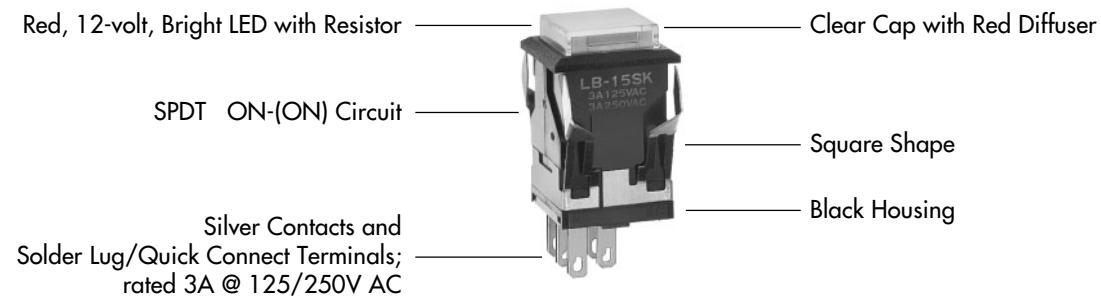

**IMPORTANT:**

Switches are supplied without UL & CSA marking unless specified. Specific models & ratings noted on General Specifications page.

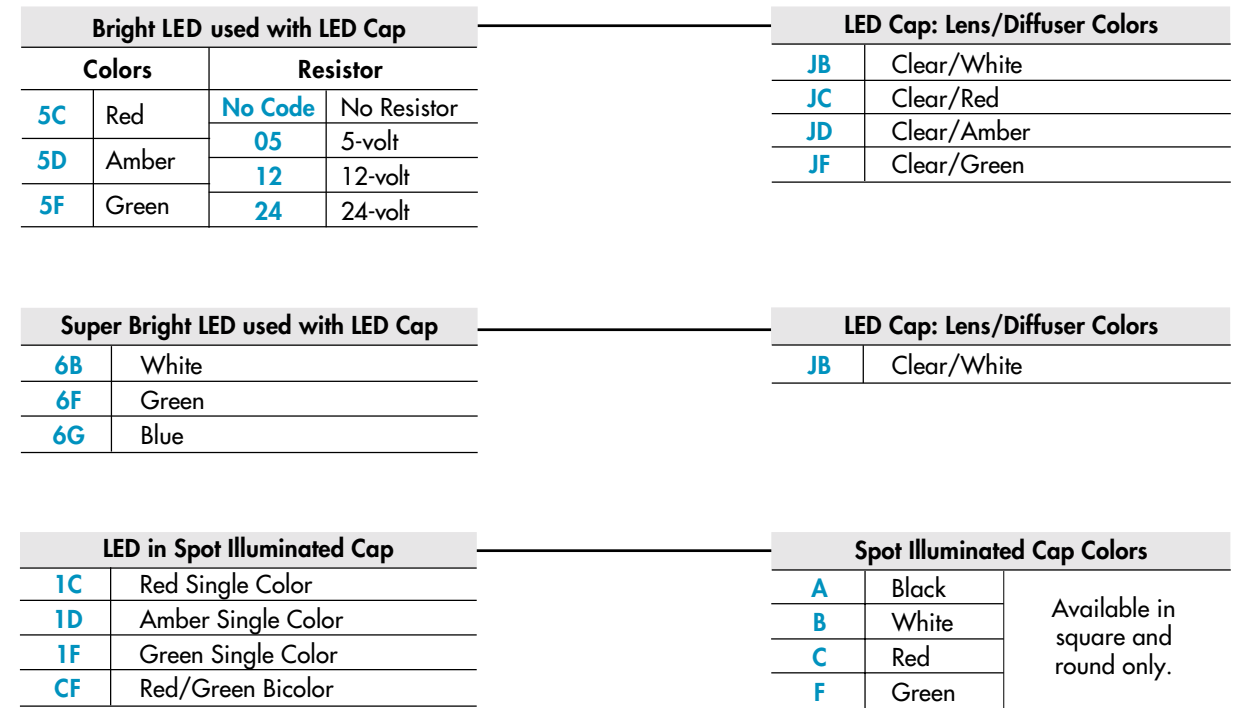

## POLES & CIRCUITS

Pole	Model	Plunger Position ( ) = Momentary		Connected Terminals		Throw & Power/Lamp Schematics
		Normal	Down	Normal	Down	
SP	LB15 *LB16	ON ON	(ON) ON	1-3	1-2	SPDT 
DP	LB25 *LB26	ON ON	(ON) ON	1-3 4-6	1-2 4-5	DPDT 

\* When in latched position for the alternate circuit, cap position is 1.0mm (.039") above the built-in bezel.

## SHAPES & PANEL CUTOUTS

**S** .622" Square

Cutout for 1 switch: .638" x .638"  
Cutout for 1 switch with barriers: .638" x .815"

**C** .854" Round

Cutout for 1 switch: .638" x .882"  
Cutout for 1 switch with barriers: .638" x 1.059"

**R** .622" x .866" Rectangular

Panel Thickness for Switches & Barriers: 1.0 ~ 4.0mm (.039" ~ .157")  
Panel Thickness for Protective Guards & Splash Covers: 1.0 ~ 3.5mm (.039" ~ .138")

## HOUSING

Housing Colors Available:



## CONTACT MATERIALS, RATINGS, & TERMINALS

**W01** Silver Contacts

Power Level  
3A @ 125V AC & 250V AC

**G01** Gold Contacts

Logic Level  
0.4VA max. @ 28V AC/DC max.

Solder Lug/Quick Connect

The .047" x .079" oblong hole accommodates one solid 18-gauge wire or two solid or stranded 20-gauge wires.

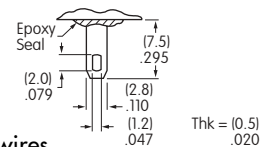

See Supplement page Z1 for complete explanation of operating range.

## INCANDESCENT & NEON LAMP CODES & SPECIFICATIONS

AT607 & AT607N

AT607 Incandescent 5-volt or 12-volt; AT607N Neon 110-volt

**05**

**12**

**01** \*

<p>T-1 Bi-pin</p>	Voltage	V	5V AC	12V AC	110V AC
	Current	I	115mA	60mA	1.5mA
	Endurance	Avg. Hrs.	7,000		10,000
	Ambient Temp. Range		-25°C ~ +50°C		

\* Recommended Resistors: 33K ohms for 110V AC; 100K ohms for 220V AC.

Electrical specifications are determined at a basic temperature of 25°C. Lamp circuit is independent of switch operation.

## LED CODES & SPECIFICATIONS



Electrical specifications are determined at a basic temperature of 25°C. LED circuit is independent of switch operation.

LEDs are colored in OFF state. For dimension drawings of lamps see Accessories & Hardware Index (page Y1).

If the source voltage is greater than rated voltage, a ballast resistor is required.

The ballast resistor calculation and more lamp detail are shown in the Supplement; see Supplement Index (page Z1).

### Bright LED without Resistor

<b>AT635</b>  LEDs are colored in OFF state.      T-1 ½ Bi-pin	Color Codes:	Red <b>5C</b>	Amber <b>5D</b>	Green <b>5F</b>	<b>No Code</b> No Resistor		
	Forward Peak Current			$I_{FM}$	30mA	30mA	30mA
	Continuous Forward Current			$I_F$	20mA	20mA	40mA
	Forward Voltage			$V_F$	1.9V	2.0V	2.1V
	Reverse Peak Voltage			$V_{RM}$	5V	5V	5V
	Current Reduction Rate Above 25°C			$\Delta I_F$	0.42mA/°C	0.29mA/°C	0.42mA/°C
	Ambient Temperature Range				-25°C ~ +50°C		

### Bright LED with Resistor

<b>AT627 with Resistor</b>    T-1 Bi-pin	Color Codes:	Red <b>5C</b>	Amber <b>5D</b>	Green <b>5F</b>	Resistor Codes		
					<b>05</b>	<b>12</b>	<b>24</b>
	Forward Peak Current			$I_{FM}$	—	—	—
	Continuous Forward Current			$I_F$	52mA	26mA	13mA
	Forward Voltage			$V_F$	5V	12V	24V
	Reverse Peak Voltage			$V_{RM}$	4V	8V	16V
	Current Reduction Rate Above 25°C			$\Delta I_F$	0.50mA/°C		
Ambient Temperature Range				-25°C ~ +50°C			

AT627  
5-volt,  
4-element  
with Resistor

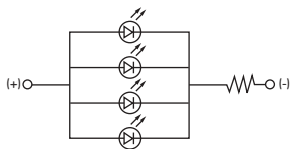

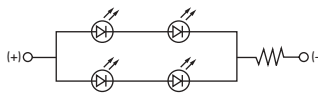

AT627  
12-volt,  
4-element  
with Resistor

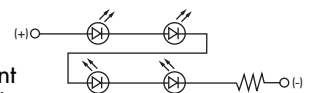

AT627  
24-volt,  
4-element  
with Resistor



### Super Bright Single Element LED

<b>AT625G Blue</b> <b>AT631B White</b> <b>AT632F Green</b>      T-1 Bi-pin			Colors:	<b>6B</b> White	<b>6F</b> Green	<b>6G</b> Blue	
	Forward Peak Current			$I_{FM}$	30mA	30mA	30mA
	Continuous Forward Current			$I_F$	20mA	20mA	20mA
	Forward Voltage			$V_F$	3.6V	3.5V	3.6V
	Reverse Peak Voltage			$V_{RM}$	5V	5V	5V
	Current Reduction Rate Above 25°C			$\Delta I_F$	0.50mA/°C		
	Ambient Temperature Range				-25°C ~ +50°C		

## CAP TYPES & COLOR COMBINATIONS

Color Codes: A Black B White C Red D Amber E Yellow F Green G Blue J Clear

### Solid Cap for Incandescent Lamp

Lens/Filter  
Colors Available:

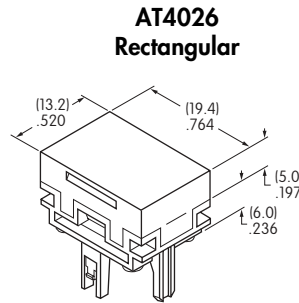
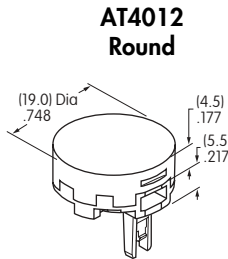
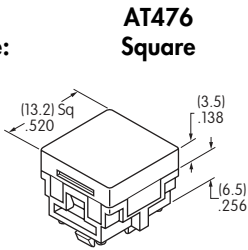
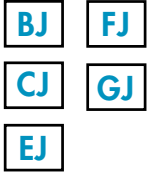

Material: Polycarbonate Finish: Glossy

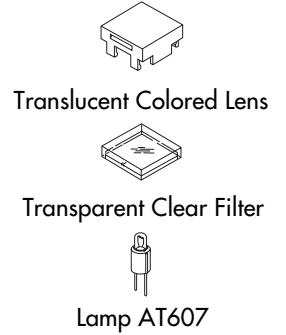

### Insert Cap for Incandescent or Neon Lamp

Lens/Filter  
Colors Available:

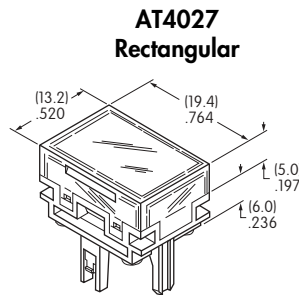
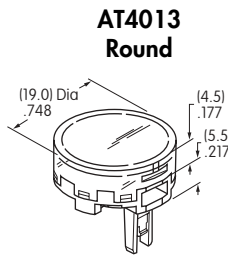
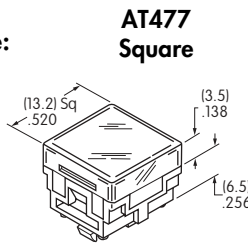
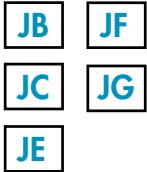

Material: Polycarbonate Finish: Glossy

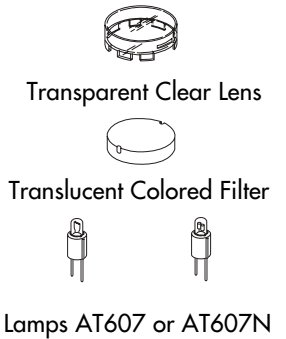

JF & JG not suitable with neon.

### Cap for Bright LED without Resistor

Lens/Diffuser  
Colors Available:

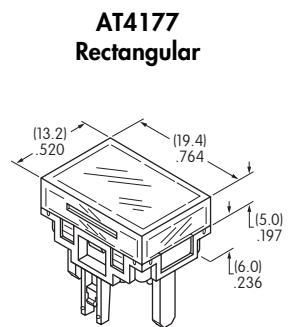
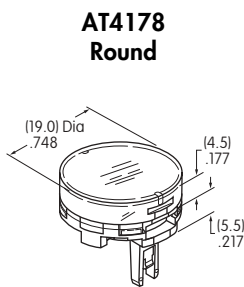
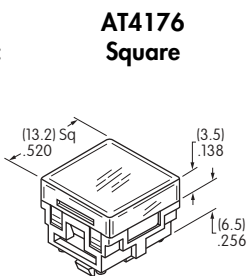

Material: Polycarbonate Finish: Glossy

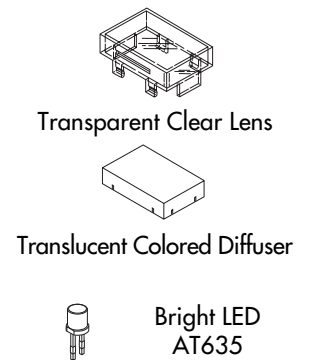

### Cap for Bright LED with Resistor

Lens/Diffuser  
Colors Available:

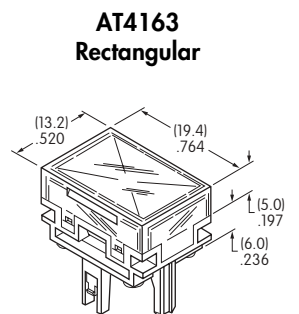
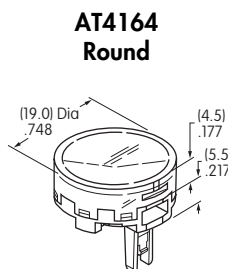
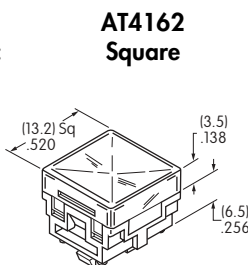

Material: Polycarbonate Finish: Glossy

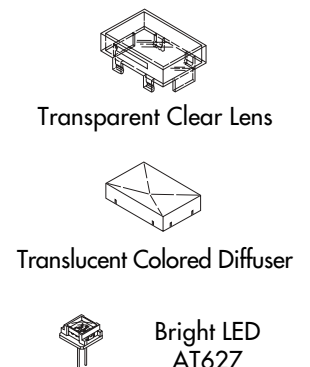

## CAP TYPES & COLOR COMBINATIONS

Color Codes: A Black B White C Red D Amber E Yellow F Green G Blue H Gray J Clear

### Cap for Super Bright LEDs

Lens/Diffuser Colors Available:

**AT4129**  
Square

**AT4128**  
Round

**AT4130**  
Rectangular

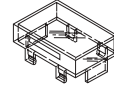

Transparent  
Clear Lens

**JB**

Material:  
Polycarbonate  
Finish: Glossy

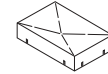
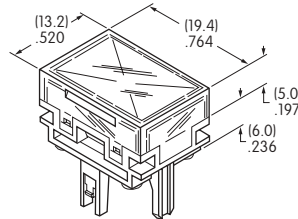
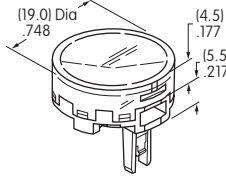
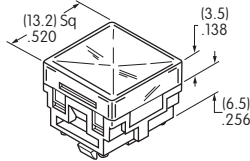

Translucent  
White Diffuser



LEDs AT625  
AT631 AT632

### Spot Illuminated Cap with LED

Electrical specifications are determined at a basic temperature of 25°C. LED circuit is independent of switch operation. Single color LEDs are colored in OFF state & bicolor translucent white in OFF state. For dimension drawings of lamps see Accessories & Hardware Index (page Y1). If the source voltage is greater than rated voltage, a ballast resistor is required. The ballast resistor calculation and more lamp detail are shown in the Supplement; see Supplement Index (page Z1).

### LED Specifications

LED factory assembled in Spot Illuminated Caps	Single Color LED with 1 Element	Bicolor LED with 2 Elements	Single Color			Bicolor
			1C	1D	1F	CF
Not Available Separately	Forward Peak Current	$I_{FM}$	10mA	30mA	30mA	30/25mA
	Continuous Forward Current	$I_F$	8mA	24mA	24mA	20mA
	Forward Voltage	$V_F$	1.9V	2.0V	2.1V	2.0/2.2V
	Reverse Peak Voltage	$V_{RM}$	5V	5V	5V	—
	Current Reduction Rate Above 25°C	$\Delta I_F$	0.13mA/°C	0.40mA/°C	0.40mA/°C	0.43/38mA/°C
	Ambient Temperature Range	-25°C ~ +50°C				

Cap Colors Available:

**A**

**B**

**C**

**F**

**AT480**  
Square

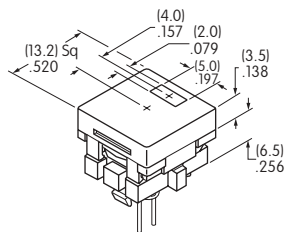

**AT4016**  
Round

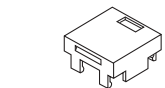
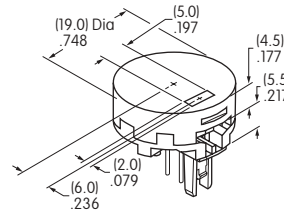

Cap with Window



Factory Assembled LED;  
Not Available Separately

Material: Polycarbonate Finish: Glossy

When ordering spot illuminated cap separately, LED color must be specified.  
Examples: AT480CA (red LED, black cap); AT4016CFB (red/green bicolored LED, white cap)



## TYPICAL SWITCH DIMENSIONS

### Square

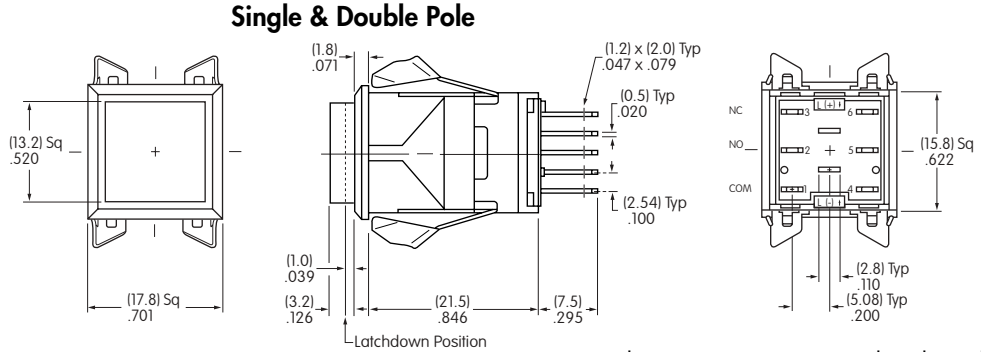

LB15SKW01-12-CJ

Terminals 4, 5, & 6 are not on single pole models.

### Round

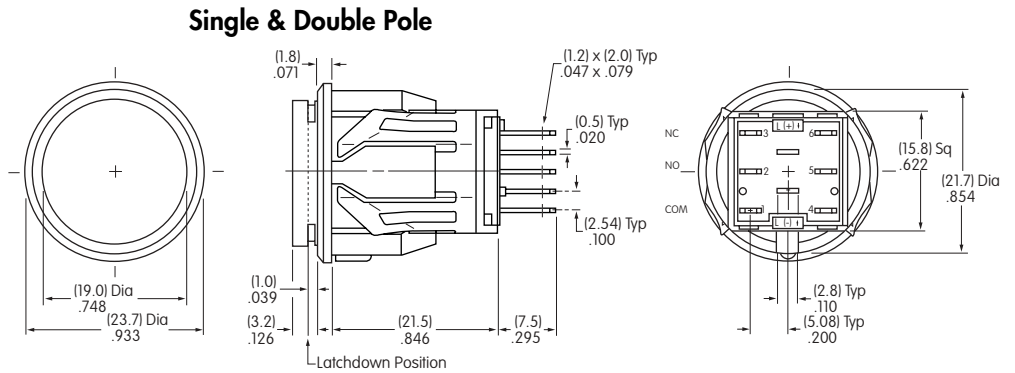

LB16CKW01-12-CJ

Terminals 4, 5, & 6 are not on single pole models.

### Rectangular

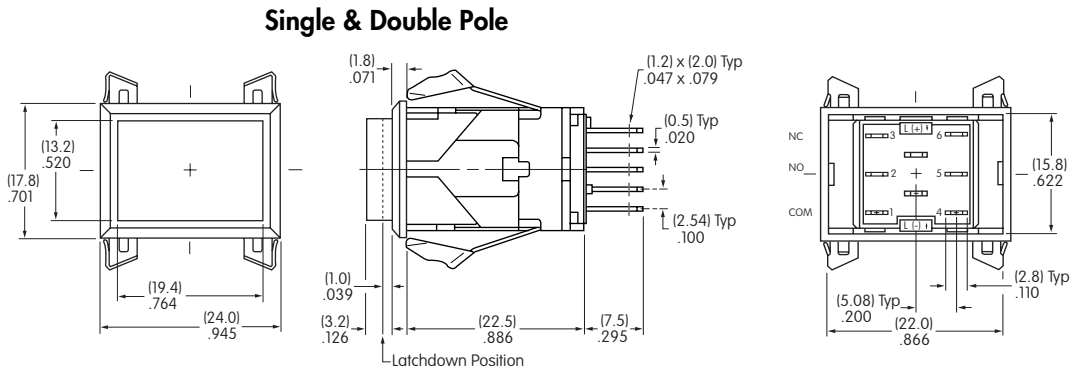

LB26RGW01-12-CJ

Terminals 4, 5, & 6 are not on single pole models.

## OPTIONAL ACCESSORIES

### PCB Adaptors

#### AT711 Single Pole • Straight PC Terminals

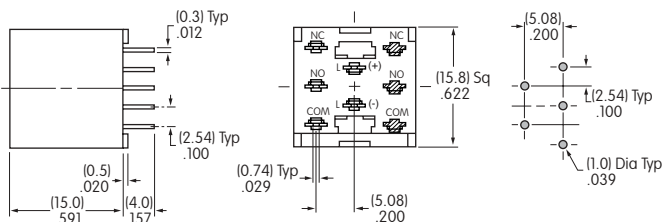

#### AT712 Double Pole • Straight PC Terminals

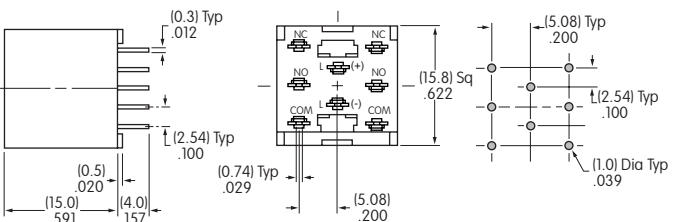

Note: Order adaptors separately.



## OPTIONAL ACCESSORIES

### Barriers

**AT497**  
End

**AT498**  
Center

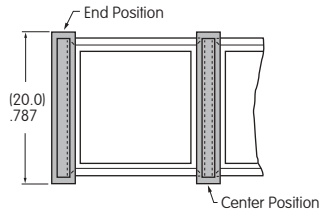

Material: Polyamide

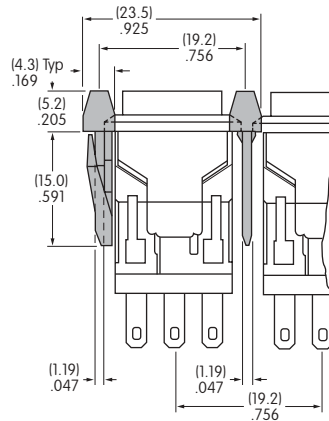

Cutouts for More Than 1 Switch

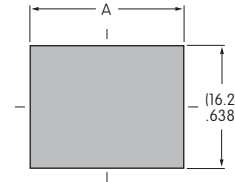

$$A = .752" \times \text{Number of Switches} + .051"$$

$$A = .996" \times \text{Number of Switches} + .051"$$

### Protective Guard

**AT499**  
Square  
Protective Guard

Opens 90°  
Closes manually

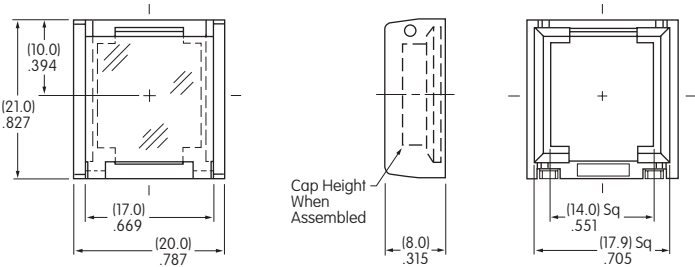
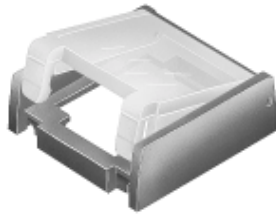

Material: Polyamide

Protective Guards reduce depth of switch behind panel by .020".

### Spring Loaded Protective Guard

**AT4171**  
Square  
Protective Guard

Opens 180°  
Closes automatically

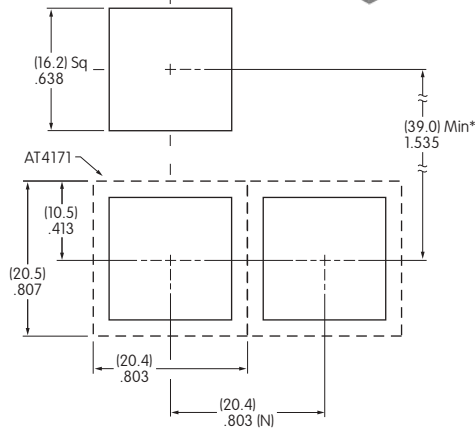
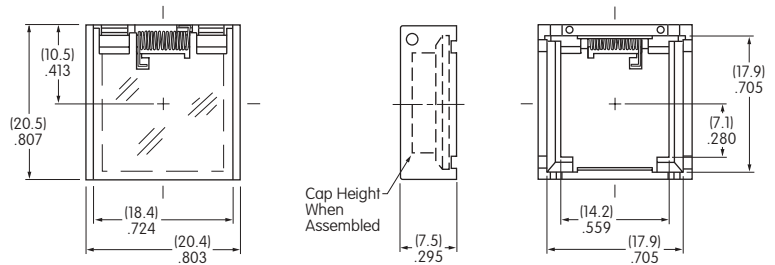
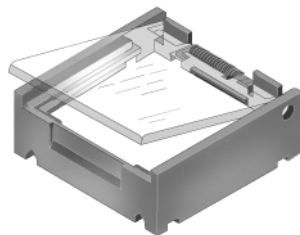

#### Materials:

Cover: Clear Polycarbonate  
Base: Black GFR Polyamide  
Coil Spring: Stainless Steel

**Recommended Panel Thickness:**  
1.0mm ~ 2.7mm (.039" ~ .106")

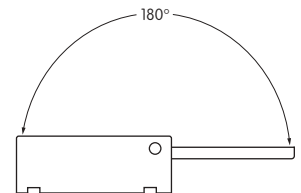

(N) = Number of switches \* Minimum dimension allows opening of cover to 180°

### OPTIONAL ACCESSORIES

#### Protective Guard

**AT4057**  
Rectangular  
Protective Guard

Opens 90°  
Closes manually

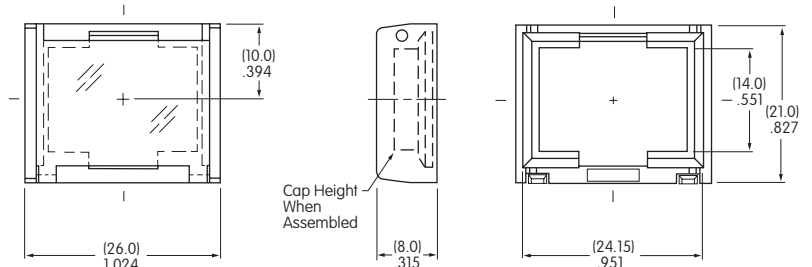
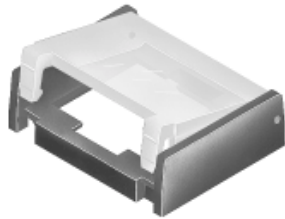

Material: Polyamide

Protective Guards reduce depth of switch behind panel by .020".

#### Spring Loaded Protective Guard

**AT4172**  
Rectangular  
Protective Guard

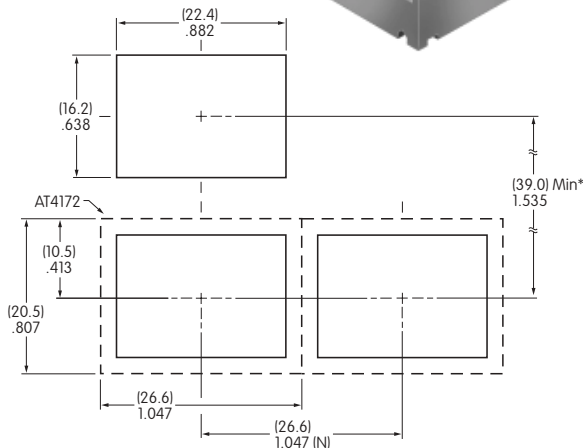
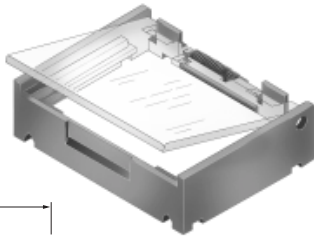

Opens 180°  
Closes automatically

**Materials:**

Cover: Clear Polycarbonate  
Base: Black GFR Polyamide  
Coil Spring: Stainless Steel

Recommended Panel Thickness:  
1.0mm ~ 2.7mm (.039" ~ .106")

(N) = Number of switches \* Minimum dimension allows opening of cover to 180°

#### Splash Covers

**AT4002**  
Round

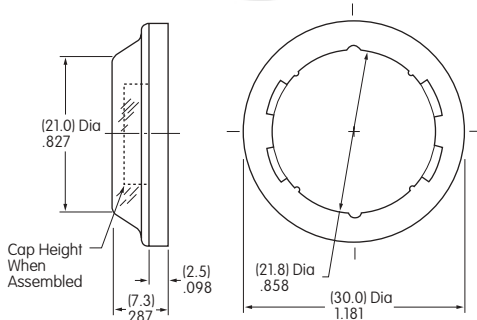

**AT4001**  
Square

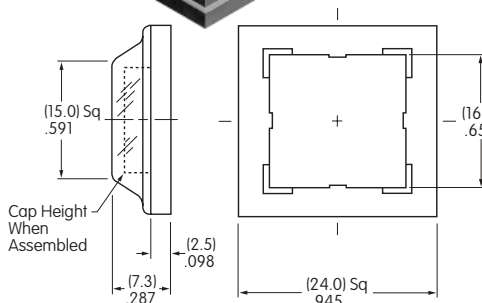
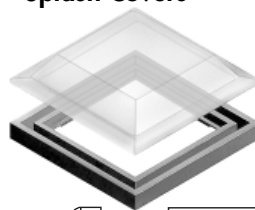

**AT4011**  
Rectangular

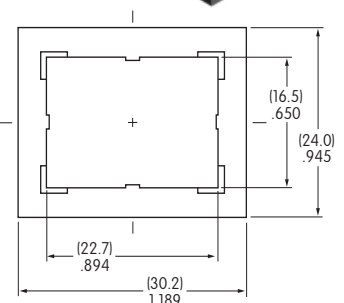
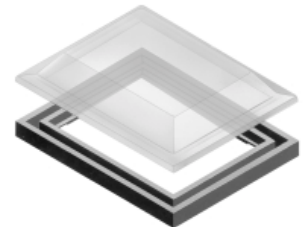

Materials: PVC with polyethylene gasket; PVC loses pliability below 0°C (32°F). Splash Covers reduce depth of switch behind panel by .020".