

### Features:

- Frequency Range: 17 – 43 GHz
- P1dB: 18 dBm
- Psat: 20 dBm
- Gain: 21 dB
- Vdd =4.5 V (3 V to 5 V)
- Ids = 250 mA (150mA to 300mA)
- Input and Output Fully Matched to 50 Ω
- 2x and 3x Frequency multiplier applications
- Surface Mount, RoHs Compliant QFN 4x4mm package

### Applications:

- Communication systems
- Microwave instrumentations

### Description:

The MMA-174321 is a broadband GaAs MMIC general purpose gain block for 0.1-Watt maximum output power and high gain over full 17 to 43GHz frequency range. This amplifier is able to use as 2x and 3x Frequency multipliers when biased under class-B condition for the first stage.

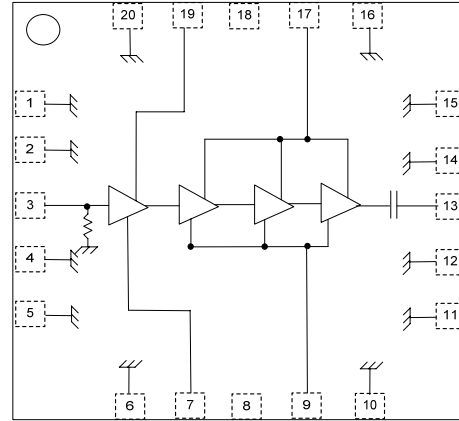

Functional Block Diagram

### Absolute Maximum Ratings: (Ta= 25 °C)\*

SYMBOL	PARAMETERS	UNITS	Min.	Max.
Vd1, Vd2	Drain-Supply Voltage	V		5.4
Vg1	Optional Gate supply Voltage	V	-2	0.5
Vg2	Optional Gate supply Voltage	V	-2	0.5
Idd	Total Drain Supply Current	mA		400
Pin max	RF Input Power	dBm		21
Toper	Operating Temperature	°C		-40 to +85
Tch	Channel Temperature	°C		+150
Tstg	Storage Temperature	°C		-55 to +165
Tmax	Max. Assembly Temp (60 sec max)	°C		+300

\*Operation of this device above any one of these parameters may cause permanent damage.



# MMA-174321-M4

17-43GHz, 0.1W Gain Block  
Data Sheet

## Electrical Specifications: $V_{ds}=4.5V, V_{gs}=-0.7V, I_{ds}=250mA, T_a=25\text{ }^\circ\text{C}, Z_0=50\text{ ohm}$

Parameter	Units	Typical Data
Frequency Range	GHz	17-43
Gain (Typ / Min)	dB	21 / 18
Gain Flatness (Typ / Max)	+/-dB	2.5 / 3
Input RL(Typ/Max)	dB	8/5
Output RL(Typ/Max)	dB	8/3
Output P1dB(Typ/Min)	dBm	18/16
Output IP3 (1)	dBm	26
Output Psat(Typ/Min)	dBm	20/17
Operating Current at P1dB (Typ/Max)	mA	230 / 250
Thermal Resistance	$^\circ\text{C} / \text{W}$	30

(1) Output IP3 is measured with two tones at output power of 5 dBm/tone separated by 20 MHz.

## Typical RF Performance: $V_{ds}=4.5V$ , $V_{gs}=-0.7V$ , $I_{ds}=250mA$ , $Z_0=50\ \Omega$ , $T_a=25\ ^\circ C$

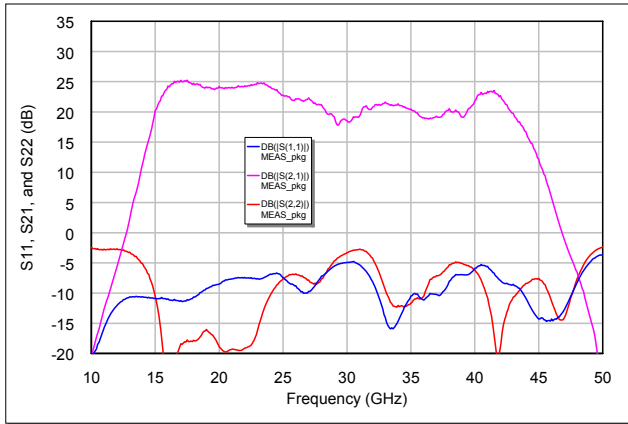

S11[dB], S21[dB], and S22[dB] vs. Frequency

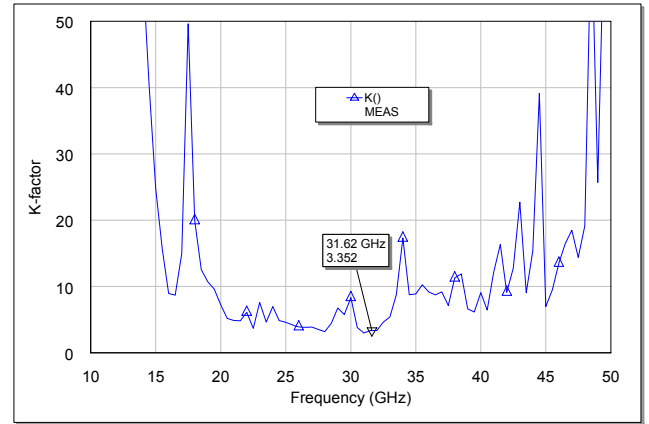

K-factor vs. Frequency

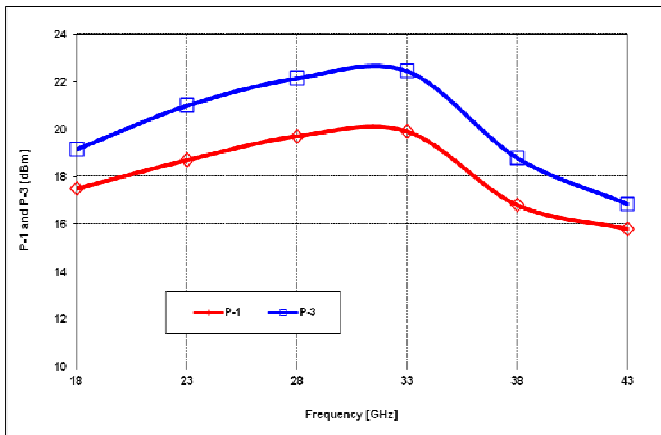

P-1 and Psat vs. Frequency

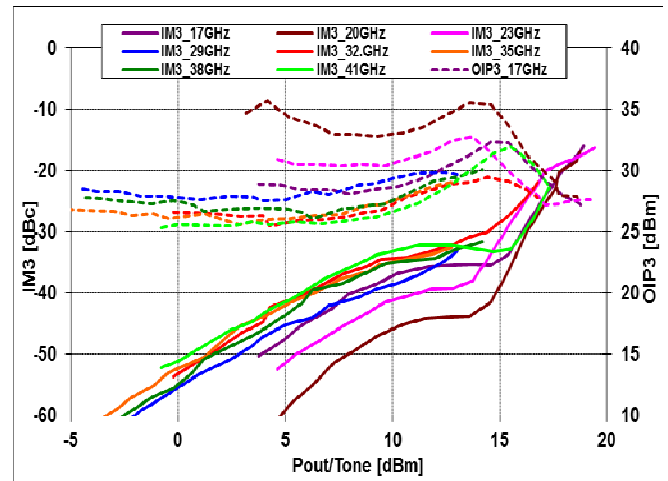

IM3 level [dBc] vs. Input power [dBm/tonne]

## Frequency 2x and 3x multiplier Data:

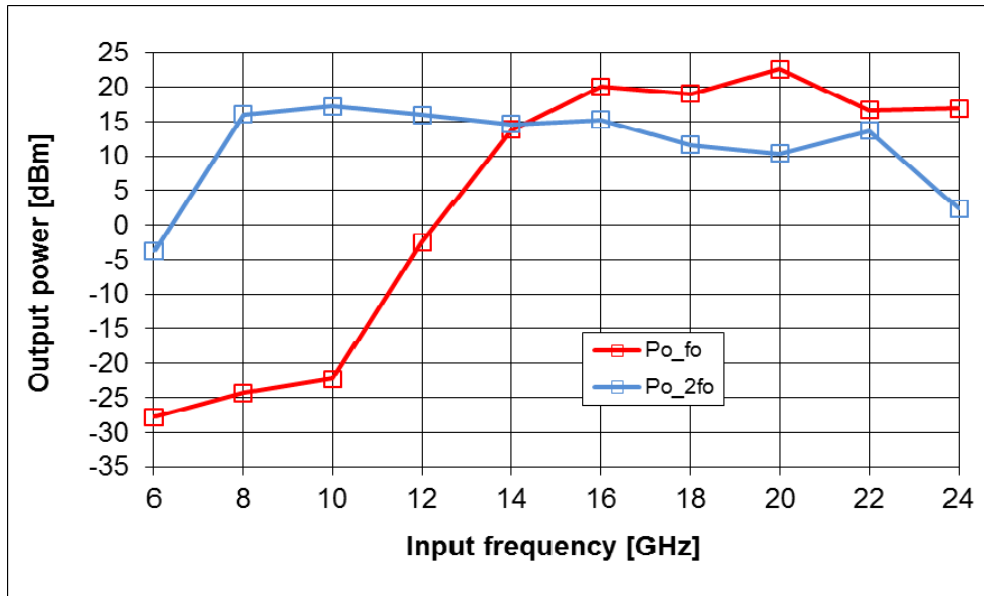

Measured 2x multiplier data: Pin=9dBm, Vd1=5V, Vd2=5V, Vg1=-1.4V, Vg2=-0.7V, Id1=1mA, and Id2=163mA

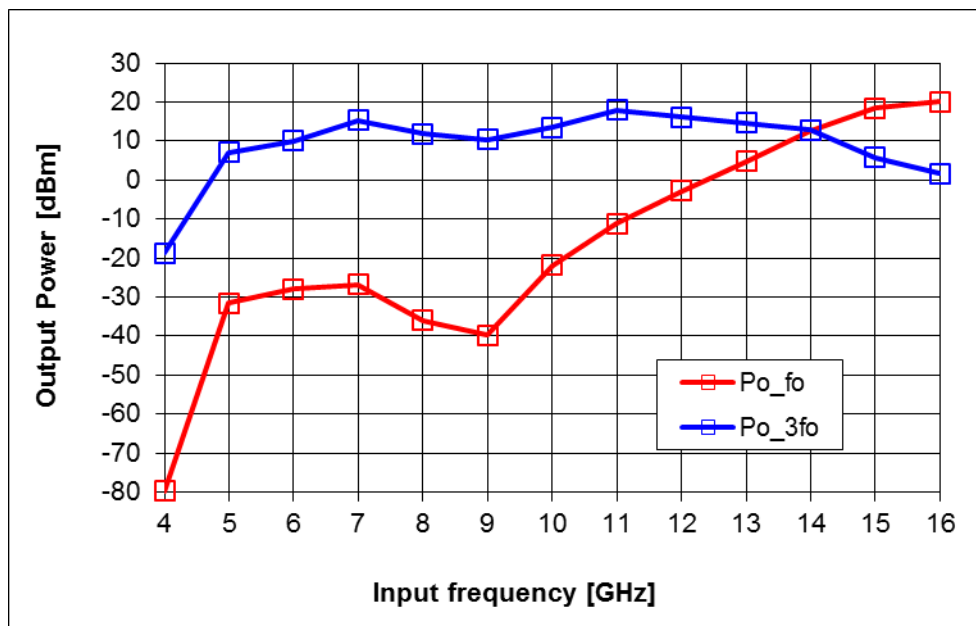

Measured 3x multiplier data: Pin=9dBm, Vd1=1V, Vd2=5V, Vg1=-0.75V, Vg2=-0.75V, Id1=21mA, and Id2=144mA

## Typical Over Temperature Performance: $V_{ds}=4.5V$ , $I_{ds}=250mA$ , $Z_0=50\text{ ohm}$ , $T_a=-40, 25, \text{ and } 85\text{ }^\circ\text{C}$

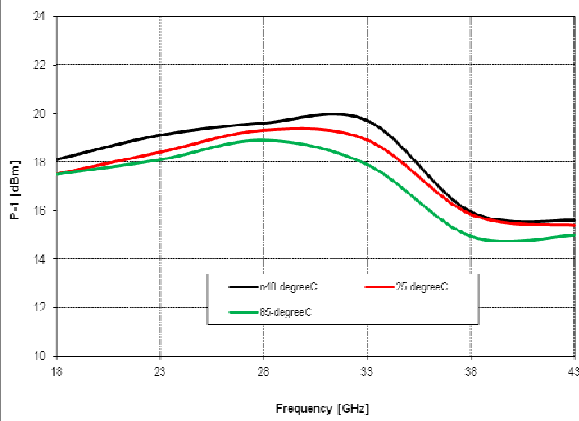

P1 over temperature

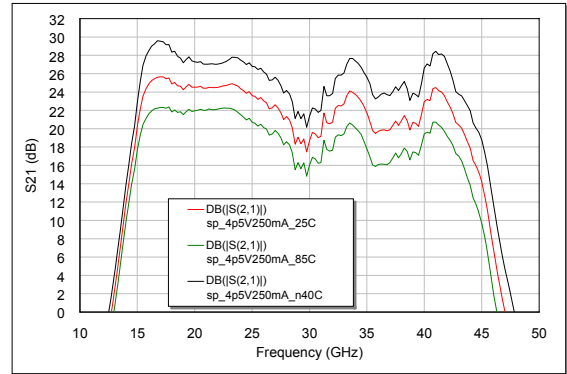

S21(dB) over temperature

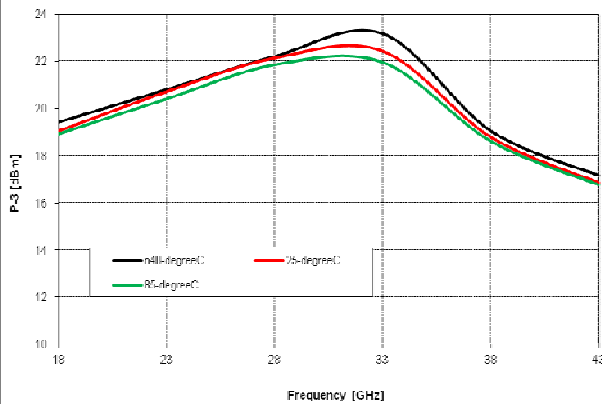

P-3 over temperature

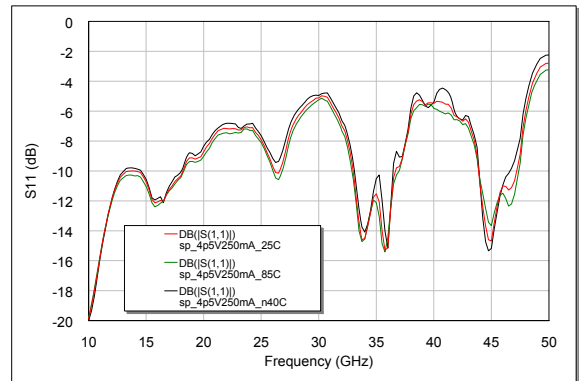

S11(dB) over temperature

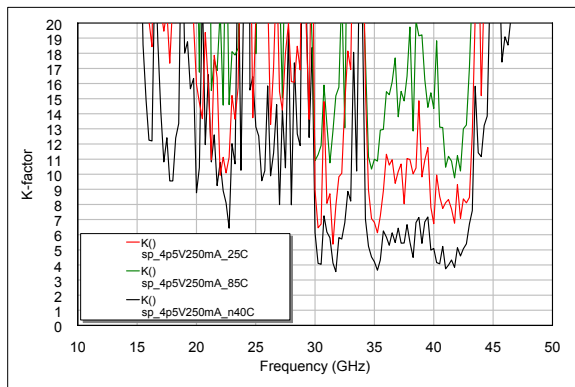

K-factor over temperature

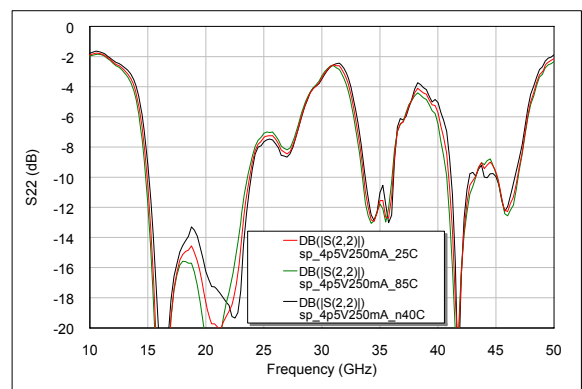

S22(dB) over Voltage

---

## Applications

The **MMA-174321-M4** MMIC power amplifier is designed for use as a power stage amplifier in microwave transmitters. It is ideally suited for 17 to 43GHz band applications requiring a flat gain response and excellent power performance. This amplifier is packaged in QFN 4X4.

## Biassing and Operation

The recommended bias conditions for best performance for the **MMA-174321-M4** are  $V_{DD} = 4.5V$ ,  $I_{dsq} = 250mA$ . Performance improvements are possible depending on applications. The drain bias voltage range is 3 to 5V and the quiescent drain current biasing range is 150mA to 300mA.  $V_{g1}$  is connected to first stages of gate, and  $V_{g2}$  is connected to following three stages of gates. Muting can be accomplished by setting  $V_{g1}$  and  $V_{g2}$  to the pinched-off voltage ( $V_p = -2V$ ). The gate voltages ( $V_{g1}$  and  $V_{g2}$ ) should be applied prior to the drain voltages ( $V_{d1}$  and  $V_{d2}$ ) during power up and removed after the drain voltages during power down. The RF input port is connected internally to the 50Ω load for ESD protection purpose; therefore, an input decoupling capacitor is needed if the preceding output stage has DC present. The RF output is DC decoupled internally. Typical DC supply connection with bi-passing capacitors for the **MMA-174321-M4** is shown in following pages.

## Frequency x2 and x3 Multiplier Applications:

**MMA-174321-M4** is able to use as a frequency x2 multiplier when biased under  $V_{d1} = 5V$ ,  $V_{d2} = 5V$ ,  $V_{g1} = -1.4V$ ,  $V_{g2} = -0.7V$ ,  $I_{d1} = 1mA$ , and  $I_{d2} = 163mA$ . Optimum input RF power level is +9dBm. Typical measured data is shown in previous page. **MMA-174321-M4** is also able to use as a frequency x3 multiplier when biased under  $V_{d1} = 1V$ ,  $V_{d2} = 5V$ ,  $V_{g1} = -0.75V$ ,  $V_{g2} = -0.75V$ ,  $I_{d1} = 21mA$ , and  $I_{d2} = 144mA$ . Optimum input RF power level is +9dBm. Typical measured data is shown in previous page.

## Assembly Techniques

GaAs MMICs are ESD sensitive. ESD preventive measures must be employed in all aspects of storage, handling, and assembly. MMIC ESD precautions, handling considerations, die attach and bonding methods are critical factors in successful GaAs MMIC performance and reliability.

## Package Pin-out:

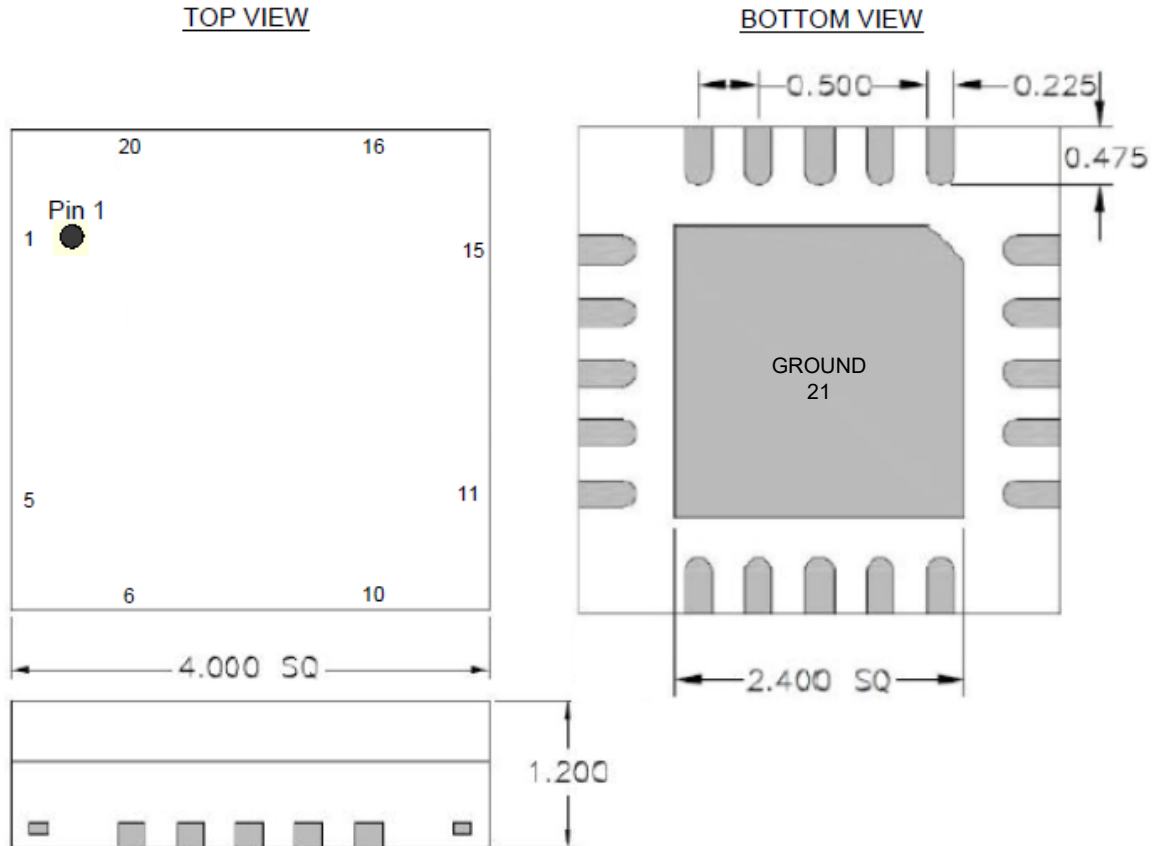

The units are in [mm].

Pin	Description
3	RF Input
13	RF Output
7	Vg1
9	Vg2
19	Vd1
17	Vd2
1, 2, 4, 5, 6, 10, 11, 12, 14, 15, 16, 20, 21	Ground
8, 18	N/C

## Application Circuit:

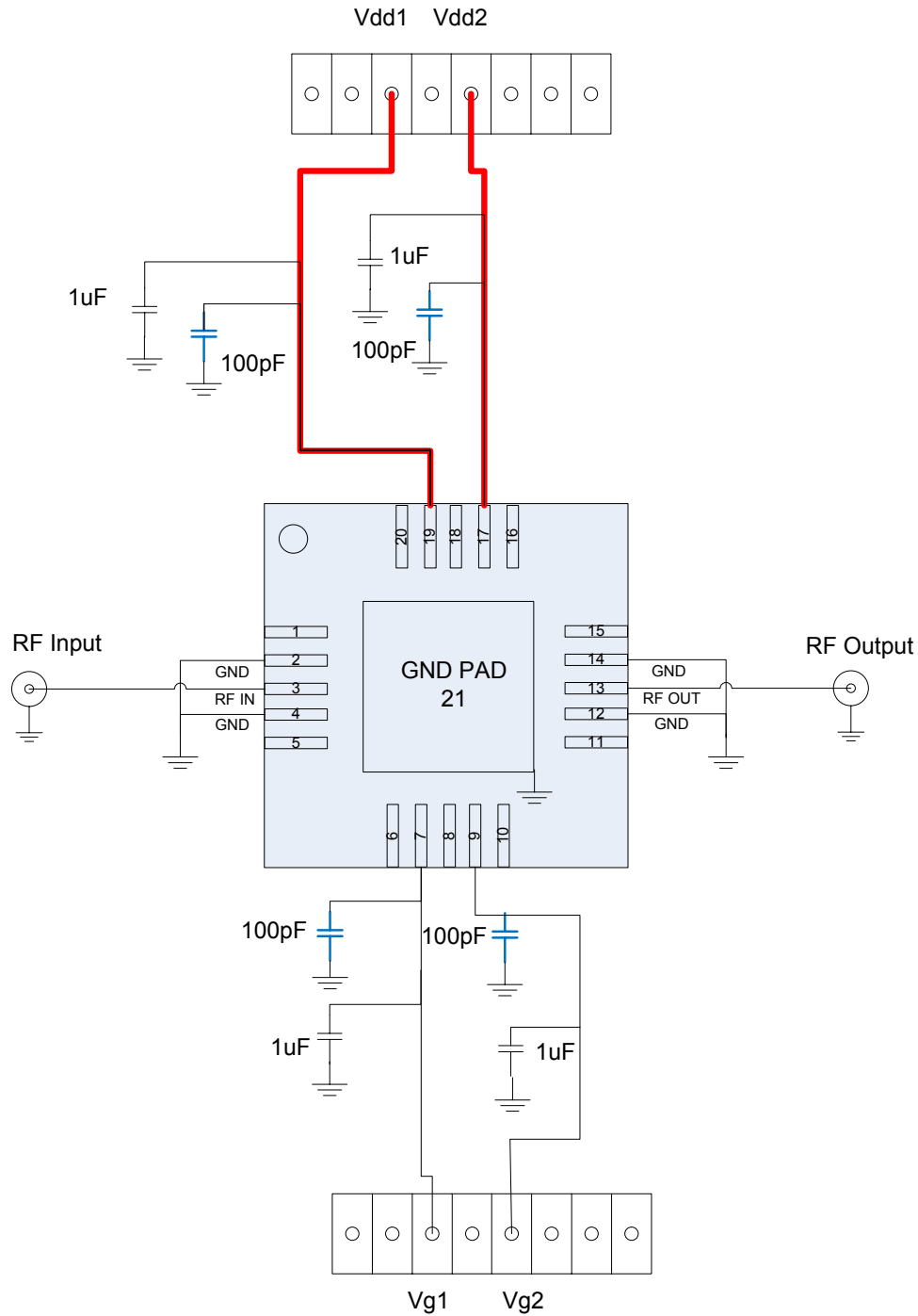



## Recommended Application Board Design:

Board Material is 10mil (Dielectric) thickness Rogers 4350B with 0.5oz copper clads.

Board is soldered on a gold plated solid copper block and adequate heat-sinking is required for 1.5W total maximum power dissipation.

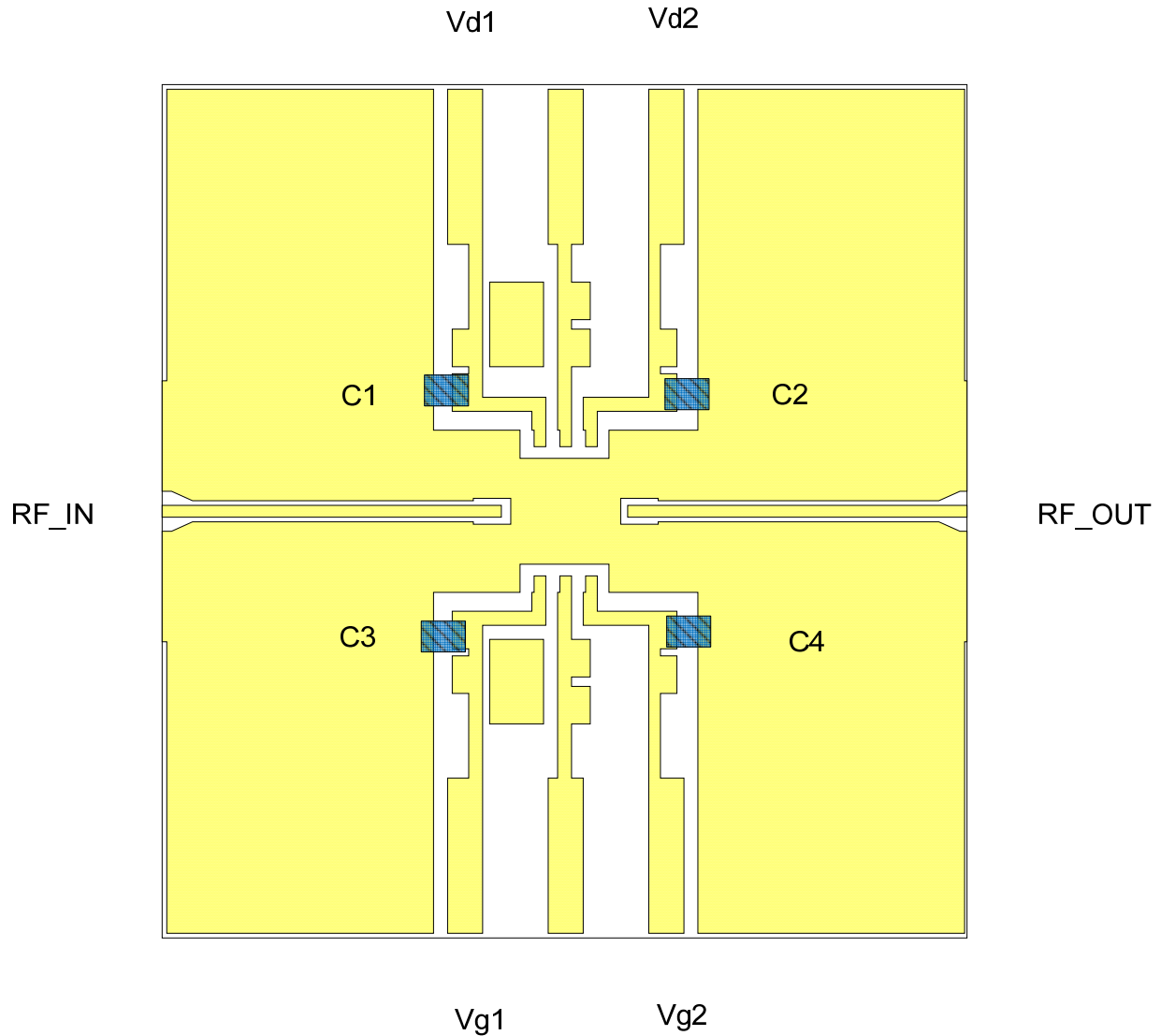

Part	Description
C1, C2, C3, C4	0.1uF capacitor (0603)

## Recommended Application Board Design:

Board Material is 10mil (Dielectric) thickness Rogers 4350B with 0.5oz copper clads. The board material and mounting pattern, as defined in the data sheet, optimizes RF performance and is strongly recommended. An electronic drawing of the land pattern is available upon request from MwT Sales & Application Engineering.

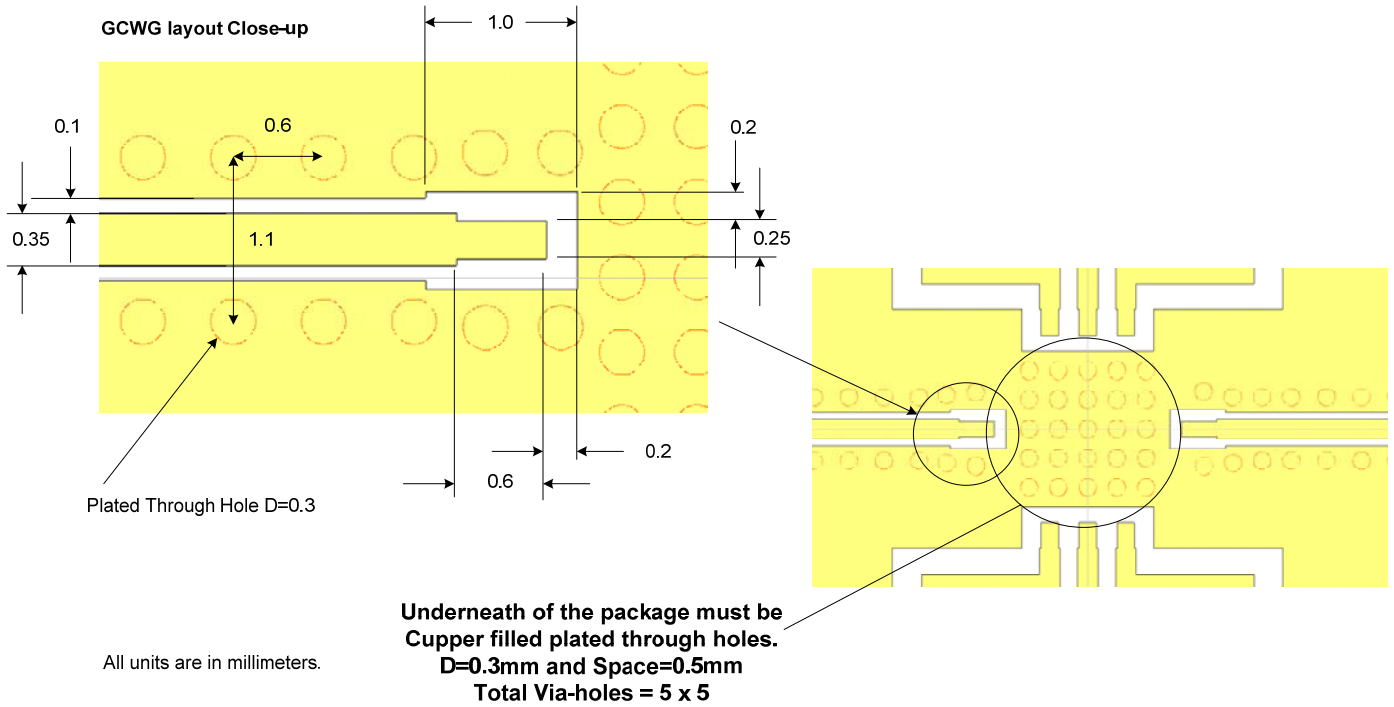

Copper filled thru vias  
D=0.3mm, Space=0.5mm  
7x7

For best thermal  
dissipation, 3mm square  
Copper filled PCB is  
recommended.

