

THIS DOCUMENT IS SUBJECT TO CHANGE WITHOUT NOTICE. IT IS CONFIDENTIAL AND A PROPERTY OF Amphenol LTW. DISCLOSURE TO THIRD PARTY HAS TO BE AUTHORIZED BY Amphenol LTW.

REV.	ECN NO.	DATE	SIGN	DESCRIPTION
A	-	2022-03-02	Jiahe Lin	Rev.01 To Rev.A

MSAS-XXPFFR-EE0001

XX: No. Of Pin

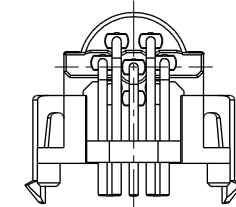
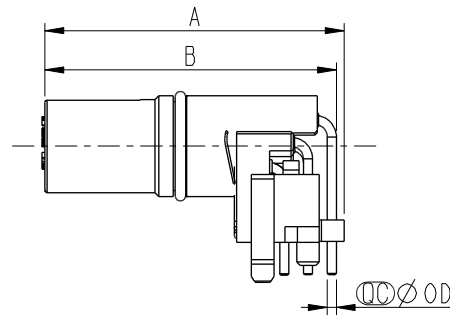
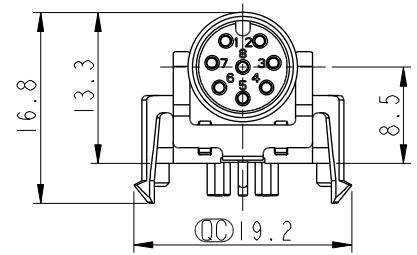
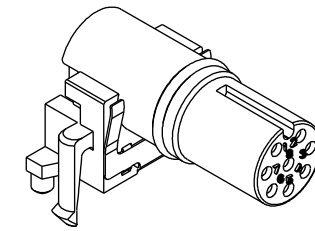
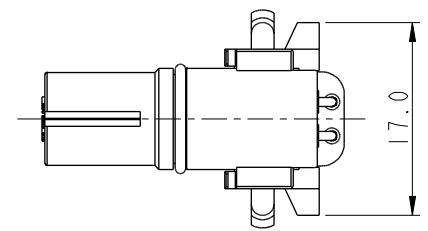

MSAS-03PFFR-EE0001	26.6	25.5	1.0
MSAS-04PFFR-EE0001	26.6	25.5	1.0
MSAS-05PFFR-EE0001	26.6	25.5	1.0
MSAS-08PFFR-EE0001	26.4	25.7	0.8
Item No.	A	B	OD

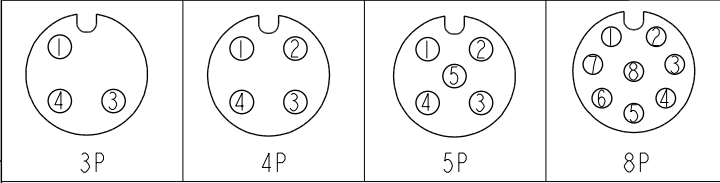

Pin Assignment Front View

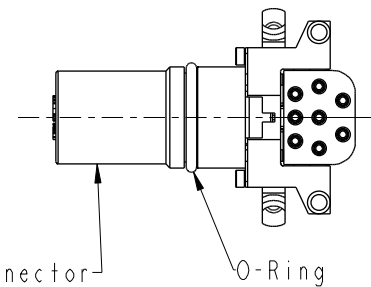

Note:

- \* RoHS Compliant
- \*  $\varnothing$  Important dimension
- \* Waterproof rate: Non-Waterproof
- \* Connector
- Housing: Thermoplastic, Black
- Pin: Copper alloy, Gold plated
- O-Ring: Rubber, Gray
- \* For pcb thickness max: 1.6mm

UNIT: mm		
TOLERANCE		
.X	±0.25	
.XX	±0.1	
.XXX	±0.05	
ANGLES	±1°	

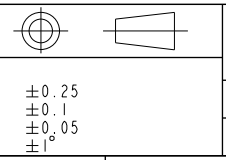

TITLE N SEN, M12 A -SHLD, RECEPTACLE, F, F, PCB R			
SCALE 3:2	SIZE A4	SHEET 1 OF 2	
REV. A	WC-REV. A.3	$\varnothing$ : Inspection item	

**Amphenol LTW**  
安費諾亮泰企業股份有限公司

ITEM NO.	DRAWN BY Jiahe Lin	DATE 2022-03-02
DWG NO. MSAS-XXPFFR-EE0001	CHECKED BY Allen Pan	DATE 2022-03-02
CUSTOMER ALTW	APPROVED BY Fred Lee	DATE 2022-03-02

THIS DOCUMENT IS SUBJECT TO CHANGE WITHOUT NOTICE. IT IS CONFIDENTIAL AND A PROPERTY OF Amphenol LTW. DISCLOSURE TO THIRD PARTY HAS TO BE AUTHORIZED BY Amphenol LTW.

PCB Layout

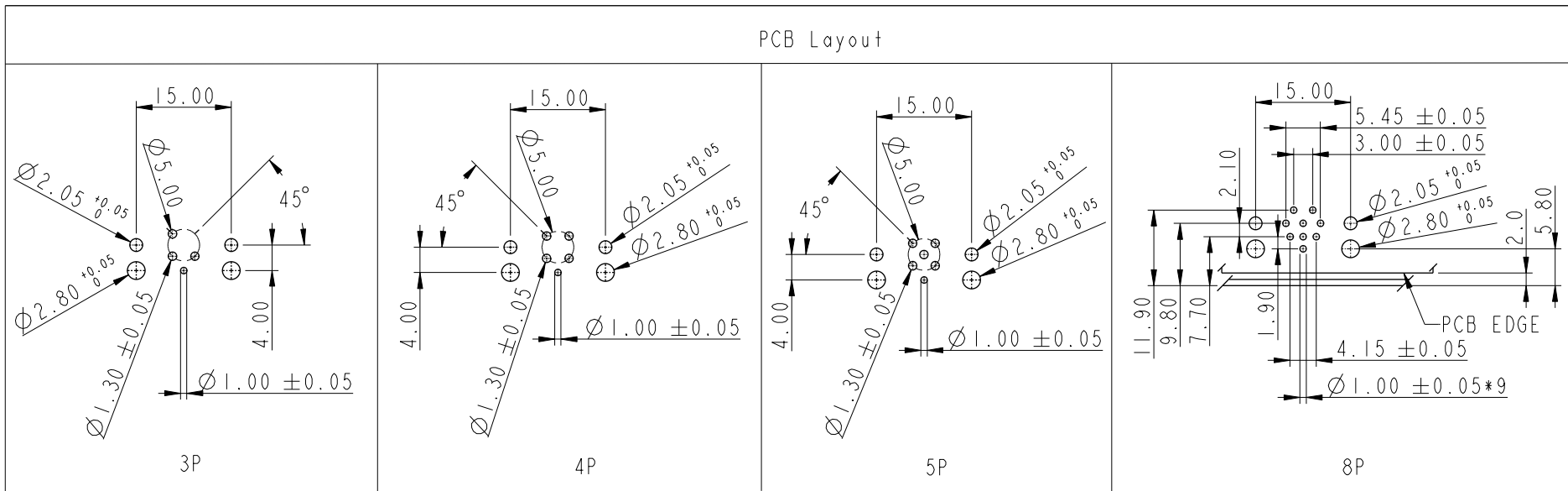

UNIT: mm		
TOLERANCE	.X	$\pm 0.25$
	.XX	$\pm 0.1$
	.XXX	$\pm 0.05$
ANGLES		$\pm 1^\circ$

TITLE N SEN, M12 A -SHLD, RECEPTACLE, F, F, PCB R		
SCALE 3:2	SIZE A4	SHEET 2 OF 2
REV. A	WC-REV. A.3	Inspection item

**Amphenol LTW**  
安費諾亮泰企業股份有限公司

ITEM NO	DWG NO
	MSAS-XXPFFR-EE0001
CUSTOMER	ALTW

DRAWN BY	CHECKED BY
Jiahe Lin	Allen Pan
APPROVED BY	
Fred Lee	

DATE	DATE	DATE
2022-03-02	2022-03-02	2022-03-02