

# NCL30083

## Dimmable Quasi-Resonant Primary Side Current-Mode Controller for LED Lighting with Thermal Fold-back

The NCL30083 is a PWM current mode controller targeting isolated flyback and non-isolated constant current topologies. The controller operates in a quasi-resonant mode to provide high efficiency. Thanks to a novel control method, the device is able to precisely regulate a constant LED current from the primary side. This removes the need for secondary side feedback circuitry, biasing and an optocoupler.

The device is highly integrated with a minimum number of external components. A robust suite of safety protection is built in to simplify the design. This device is specifically intended for very compact space efficient designs. It supports step dimming by monitoring the AC line and detecting when the line has been toggled on-off-on by the user to reduce the light intensity in 5 steps down to 5% dimming.

### Features

- Quasi-resonant Peak Current-mode Control Operation
- Primary Side Sensing (no optocoupler needed)
- Wide  $V_{CC}$  Range
- Source 300 mA/Sink 500 mA Totem Pole Driver with 12 V Gate Clamp
- Precise LED Constant Current Regulation  $\pm 1\%$  Typical
- Line Feed-forward for Enhanced Regulation Accuracy
- Low LED Current Ripple
- 250 mV  $\pm 2\%$  Guaranteed Voltage Reference for Current Regulation
- $\sim 0.9$  Power Factor with Valley Fill Input Stage
- Low Start-up Current (13  $\mu$ A typ.)
- 5 State Quasi-log Dimmable
- Thermal Fold-back
- Programmable soft-start
- Wide Temperature Range of  $-40$  to  $+125^\circ\text{C}$
- Pb-free, Halide-free MSL1 Product
- Robust Protection Features
  - ◆ Over Voltage / LED Open Circuit Protection
  - ◆ Over Temperature Protection
  - ◆ Secondary Diode Short Protection
  - ◆ Output Short Circuit Protection
  - ◆ Shorted Current Sense Pin Fault Detection

### Typical Applications

- Integral LED Bulbs
- LED Power Driver Supplies
- LED Light Engines



ON Semiconductor®

[www.onsemi.com](http://www.onsemi.com)

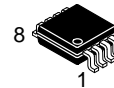

Micro8  
DM SUFFIX  
CASE 846A



SOIC-8  
D SUFFIX  
CASE 751

### MARKING DIAGRAM

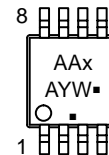

AAX = Specific Device Code  
x = E or F  
A = Assembly Location  
Y = Year  
W = Work Week  
▪ = Pb-Free Package  
(Note: Microdot may be in either location)

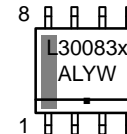

L30083x = Specific Device Code  
x = B  
A = Assembly Location  
L = Wafer Lot  
Y = Year  
W = Work Week  
▪ = Pb-Free Package

- ◆ Latched and Auto-recoverable Versions
- ◆ Brown-out
- ◆  $V_{CC}$  Under Voltage Protection
- ◆ Thermal Shutdown

### PIN CONNECTIONS

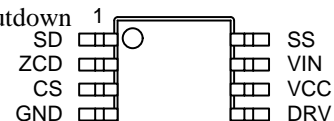

(Top View)

### ORDERING INFORMATION

See detailed ordering and shipping information in the package dimensions section on page 35 of this data sheet.

# NCL30083

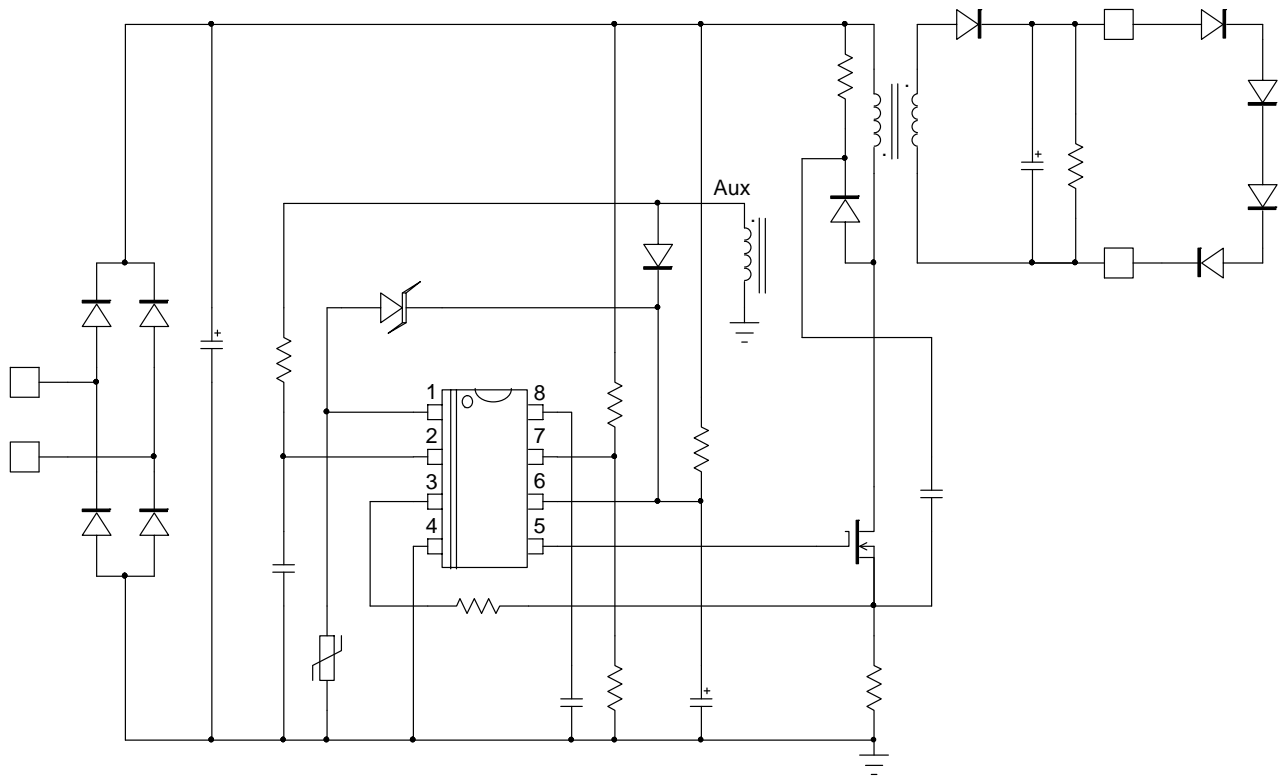

Figure 1. Typical Application Schematic for NCL30083

Table 1. PIN FUNCTION DESCRIPTION

Pin No	Pin Name	Function	Pin Description
1	SD	Thermal Fold-back and shutdown	Connecting an NTC to this pin allows reducing the output current down to 50% of its fixed value before stopping the controller. A Zener diode can also be used to pull-up the pin and stop the controller for adjustable OVP protection
2	ZCD	Zero Crossing Detection	Connected to the auxiliary winding, this pin detects the core reset event.
3	CS	Current sense	This pin monitors the primary peak current
4	GND	-	The controller ground
5	DRV	Driver output	The current capability of the totem pole gate drive (+0.3/-0.5 A) makes it suitable to effectively drive a broad range of power MOSFETs.
6	VCC	Supplies the controller	This pin is connected to an external auxiliary voltage.
7	VIN	Brown-Out Input voltage sensing	This pin observes the HV rail and is used in valley selection. This pin also monitors and protects for low mains conditions.
8	SS	Soft-Start	A capacitor connected to ground select the soft-start duration.

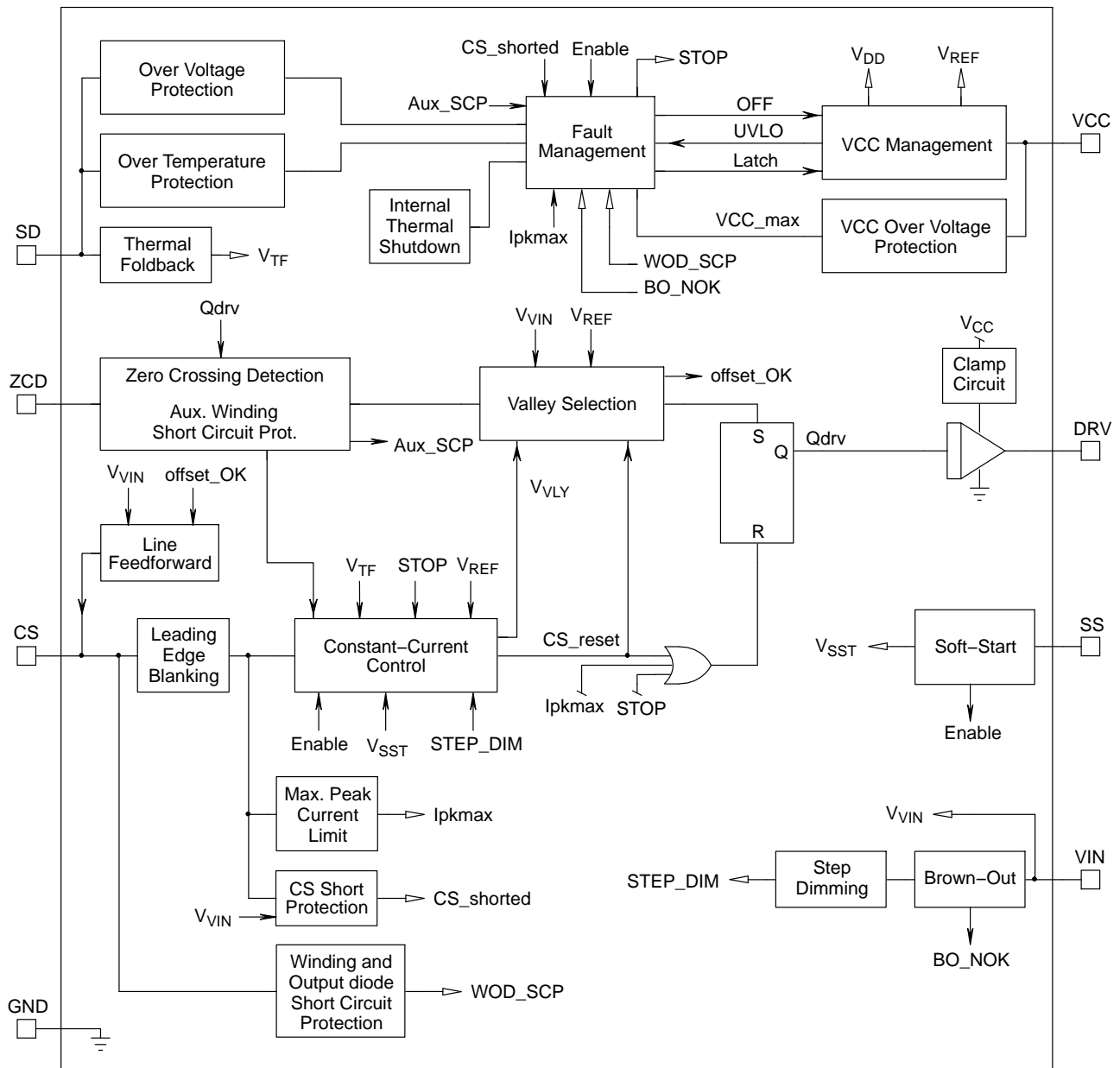

Figure 2. Internal Circuit Architecture

Table 2. MAXIMUM RATINGS TABLE

Symbol	Rating	Value	Unit
$V_{CC(MAX)}$ $I_{CC(MAX)}$	Maximum Power Supply voltage, VCC pin, continuous voltage Maximum current for VCC pin	-0.3, +35 Internally limited	V mA
$V_{DRV(MAX)}$ $I_{DRV(MAX)}$	Maximum driver pin voltage, DRV pin, continuous voltage Maximum current for DRV pin	-0.3, $V_{DRV}$ (Note 1) -500, +800	V mA
$V_{MAX}$ $I_{MAX}$	Maximum voltage on low power pins (except pins ZCD, SS, DRV and VCC) Current range for low power pins (except pins ZCD, DRV and VCC)	-0.3, +5.5 -2, +5	V mA
$V_{ZCD(MAX)}$ $I_{ZCD(MAX)}$	Maximum voltage for ZCD pin Maximum current for ZCD pin	-0.3, +10 -2, +5	V mA
$V_{SST(MAX)}$	Maximum voltage for SS pin	-0.3, +10	V
$R_{\theta J-A}$	Thermal Resistance, Junction-to-Air	289	°C/W
$T_{J(MAX)}$	Maximum Junction Temperature	150	°C
	Operating Temperature Range	-40 to +125	°C
	Storage Temperature Range	-60 to +150	°C
	ESD Capability, HBM model (Note 2)	4	kV
	ESD Capability, MM model (Note 2)	200	V

Stresses exceeding those listed in the Maximum Ratings table may damage the device. If any of these limits are exceeded, device functionality should not be assumed, damage may occur and reliability may be affected.

- $V_{DRV}$  is the DRV clamp voltage  $V_{DRV(high)}$  when  $V_{CC}$  is higher than  $V_{DRV(high)}$ .  $V_{DRV}$  is  $V_{CC}$  unless otherwise noted.
- This device series contains ESD protection and exceeds the following tests: Human Body Model 4000 V per JEDEC JESD22-A114-F and Machine Model Method 200 V per JEDEC JESD22-A115-A.
- This device contains latch-up protection and exceeds 100 mA per JEDEC Standard JESD78 except for VIN pin which passes 60 mA.

# NCL30083

**Table 3. ELECTRICAL CHARACTERISTICS** (Unless otherwise noted: For typical values  $T_J = 25^\circ\text{C}$ ,  $V_{CC} = 12\text{ V}$ ; For min/max values  $T_J = -40^\circ\text{C}$  to  $+125^\circ\text{C}$ , Max  $T_J = 150^\circ\text{C}$ ,  $V_{CC} = 12\text{ V}$ )

Description	Test Condition	Symbol	Min	Typ	Max	Unit
<b>STARTUP AND SUPPLY CIRCUITS</b>						
Supply Voltage						V
Startup Threshold	$V_{CC}$ increasing	$V_{CC(on)}$	16	18	20	
Minimum Operating Voltage	$V_{CC}$ decreasing	$V_{CC(off)}$	8.2	8.8	9.4	
Hysteresis $V_{CC(on)} - V_{CC(off)}$	$V_{CC}$ decreasing	$V_{CC(HYS)}$	8	–	–	
Internal logic reset		$V_{CC(reset)}$	3.5	4.5	5.5	
Over Voltage Protection						V
VCC OVP threshold		$V_{CC(OVP)}$	26	28	30	
$V_{CC(off)}$ noise filter		$t_{V_{CC(off)}}$	–	5	–	$\mu\text{s}$
$V_{CC(reset)}$ noise filter–		$t_{V_{CC(reset)}}$	–	20	–	
Startup current		$I_{CC(start)}$	–	13	30	$\mu\text{A}$
Startup current in fault mode		$I_{CC(sFault)}$	–	46	60	$\mu\text{A}$
Supply Current						$\text{mA}$
Device Disabled/Fault	$V_{CC} > V_{CC(off)}$	$I_{CC1}$	0.8	1.2	1.4	
Device Enabled/No output load on pin 5	$F_{sw} = 65\text{ kHz}$	$I_{CC2}$	–	2.3	4.0	
Device Switching ( $F_{sw} = 65\text{ kHz}$ )	$C_{DRV} = 470\text{ pF}$ , $F_{sw} = 65\text{ kHz}$	$I_{CC3}$	–	2.7	5.0	
<b>CURRENT SENSE</b>						
Maximum Internal current limit		$V_{ILIM}$	0.95	1	1.05	V
Leading Edge Blanking Duration for $V_{ILIM}$ ( $T_j = -25^\circ\text{C}$ to $125^\circ\text{C}$ )		$t_{LEB}$	250	300	350	ns
Leading Edge Blanking Duration for $V_{ILIM}$ ( $T_j = -40^\circ\text{C}$ to $125^\circ\text{C}$ )		$t_{LEB}$	240	300	350	ns
Input Bias Current	DRV high	$I_{bias}$	–	0.02	–	$\mu\text{A}$
Propagation delay from current detection to gate off–state		$t_{ILIM}$	–	50	150	ns
Threshold for immediate fault protection activation		$V_{CS(stop)}$	1.35	1.5	1.65	V
Leading Edge Blanking Duration for $V_{CS(stop)}$		$t_{BCS}$	–	120	–	ns
Blanking time for CS to GND short detection $V_{pinVIN} = 1\text{ V}$		$t_{CS(blank1)}$	6	–	12	$\mu\text{s}$
Blanking time for CS to GND short detection $V_{pinVIN} = 3.3\text{ V}$		$t_{CS(blank2)}$	2	–	4	$\mu\text{s}$
<b>GATE DRIVE</b>						
Drive Resistance						$\Omega$
DRV Sink		$R_{SNK}$	–	13	–	
DRV Source		$R_{SRC}$	–	30	–	
Drive current capability						$\text{mA}$
DRV Sink (Note 4)		$I_{SNK}$	–	500	–	
DRV Source (Note 4)		$I_{SRC}$	–	300	–	
Rise Time (10% to 90%)	$C_{DRV} = 470\text{ pF}$	$t_r$	–	40	–	ns
Fall Time (90% to 10%)	$C_{DRV} = 470\text{ pF}$	$t_f$	–	30	–	ns
DRV Low Voltage	$V_{CC} = V_{CC(off)} + 0.2\text{ V}$ $C_{DRV} = 470\text{ pF}$ , $R_{DRV} = 33\text{ k}\Omega$	$V_{DRV(low)}$	8	–	–	V
DRV High Voltage	$V_{CC} = 30\text{ V}$ $C_{DRV} = 470\text{ pF}$ , $R_{DRV} = 33\text{ k}\Omega$	$V_{DRV(high)}$	10	12	14	V

4. Guaranteed by design
5. OTP triggers when  $R_{NTC} = 4.7\text{ k}\Omega$

# NCL30083

**Table 3. ELECTRICAL CHARACTERISTICS** (Unless otherwise noted: For typical values  $T_J = 25^\circ\text{C}$ ,  $V_{CC} = 12\text{ V}$ ; For min/max values  $T_J = -40^\circ\text{C}$  to  $+125^\circ\text{C}$ , Max  $T_J = 150^\circ\text{C}$ ,  $V_{CC} = 12\text{ V}$ )

Description	Test Condition	Symbol	Min	Typ	Max	Unit
<b>ZERO VOLTAGE DETECTION CIRCUIT</b>						
ZCD threshold voltage	$V_{ZCD}$ increasing	$V_{ZCD(THI)}$	25	45	65	mV
ZCD threshold voltage (Note 4)	$V_{ZCD}$ decreasing	$V_{ZCD(THD)}$	5	25	45	mV
ZCD hysteresis (Note 4)	$V_{ZCD}$ increasing	$V_{ZCD(HYS)}$	10	–	–	mV
Threshold voltage for output short circuit or aux. winding short circuit detection		$V_{ZCD(short)}$	0.8	1	1.2	V
Short circuit detection Timer	$V_{ZCD} < V_{ZCD(short)}$	$t_{OVL D}$	70	90	110	ms
Auto-recovery timer duration		$t_{recovery}$	3	4	5	s
Input clamp voltage High state Low state	$I_{pin1} = 3.0\text{ mA}$ $I_{pin1} = -2.0\text{ mA}$	$V_{CH}$ $V_{CL}$	– –0.9	9.5 –0.6	– –0.3	V
Propagation Delay from valley detection to DRV high	$V_{ZCD}$ decreasing	$t_{DEM}$	–	–	150	ns
Equivalent time constant for ZCD input (Note 4)		$t_{PAR}$	–	20	–	ns
Blanking delay after on-time		$t_{BLANK}$	2.25	3	3.75	$\mu\text{s}$
Timeout after last demag transition		$t_{TIMO}$	5	6.5	8	$\mu\text{s}$
<b>CONSTANT CURRENT CONTROL</b>						
Reference Voltage at $T_J = 25^\circ\text{C}$		$V_{REF}$	245	250	255	mV
Reference Voltage $T_J = -40^\circ\text{C}$ to $125^\circ\text{C}$		$V_{REF}$	242.5	250	257.5	mV
70% reference voltage		$V_{REF70}$	–	175	–	mV
40% reference Voltage		$V_{REF40}$	–	100	–	mV
25% reference Voltage		$V_{REF25}$	–	62.5	–	mV
10% reference Voltage		$V_{REF10}$	–	25	–	mV
5% reference Voltage		$V_{REF05}$	–	12.5	–	mV
Current sense lower threshold for detection of the leakage inductance reset time		$V_{CS(low)}$	30	55	80	mV
<b>LINE FEED-FORWARD</b>						
$V_{VIN}$ to $I_{CS(offset)}$ conversion ratio		$K_{LFF}$	15	17	19	$\mu\text{A/V}$
Offset current maximum value	$V_{pinVIN} = 4.5\text{ V}$	$I_{offset(MAX)}$	67.5	76.5	85.5	$\mu\text{A}$
$V_{REF}$ value below which the offset current source is turned off	$V_{REF}$ decreases	$V_{REF(off)}$	–	37.5	–	mV
$V_{REF}$ value above which the offset current source is turned on	$V_{REF}$ increases	$V_{REF(on)}$	–	50	–	mV
<b>VALLEY SELECTION</b>						
Threshold for line range detection $V_{in}$ increasing (1 <sup>st</sup> to 2 <sup>nd</sup> valley transition for $V_{REF} > 0.75\text{ V}$ )	$V_{VIN}$ increases	$V_{HL}$	2.28	2.4	2.52	V
Threshold for line range detection $V_{in}$ decreasing (2 <sup>nd</sup> to 1 <sup>st</sup> valley transition for $V_{REF} > 0.75\text{ V}$ )	$V_{VIN}$ decreases	$V_{LL}$	2.18	2.3	2.42	V
Blanking time for line range detection		$t_{HL(blank)}$	15	25	35	ms

4. Guaranteed by design

5. OTP triggers when  $R_{NTC} = 4.7\text{ k}\Omega$

# NCL30083

**Table 3. ELECTRICAL CHARACTERISTICS** (Unless otherwise noted: For typical values  $T_J = 25^\circ\text{C}$ ,  $V_{CC} = 12\text{ V}$ ;  
For min/max values  $T_J = -40^\circ\text{C}$  to  $+125^\circ\text{C}$ , Max  $T_J = 150^\circ\text{C}$ ,  $V_{CC} = 12\text{ V}$ )

Description	Test Condition	Symbol	Min	Typ	Max	Unit
<b>VALLEY SELECTION</b>						
Valley thresholds						mV
1 <sup>st</sup> to 2 <sup>nd</sup> valley transition at LL and 2 <sup>nd</sup> to 3 <sup>rd</sup> valley HL	$V_{REF}$ decreases	$V_{VLY1-2/2-3}$	177.5	187.5	197.5	
2 <sup>nd</sup> to 1 <sup>st</sup> valley transition at LL and 3 <sup>rd</sup> to 2 <sup>nd</sup> valley HL	$V_{REF}$ increases	$V_{VLY2-1/3-2}$	185.0	195.0	205.0	
2 <sup>nd</sup> to 4 <sup>th</sup> valley transition at LL and 3 <sup>rd</sup> to 5 <sup>th</sup> valley HL	$V_{REF}$ decreases	$V_{VLY2-4/3-5}$	117.5	125.0	132.5	
4 <sup>th</sup> to 2 <sup>nd</sup> valley transition at LL and 5 <sup>th</sup> to 3 <sup>rd</sup> valley HL	$V_{REF}$ increases	$V_{VLY4-2/5-3}$	125.0	132.5	140.0	
4 <sup>th</sup> to 7 <sup>th</sup> valley transition at LL and 5 <sup>th</sup> to 8 <sup>th</sup> valley HL	$V_{REF}$ decreases	$V_{VLY4-7/5-8}$	–	75.0	–	
7 <sup>th</sup> to 4 <sup>th</sup> valley transition at LL and 8 <sup>th</sup> to 5 <sup>th</sup> valley HL	$V_{REF}$ increases	$V_{VLY7-4/8-5}$	–	82.5	–	
7 <sup>th</sup> to 11 <sup>th</sup> valley transition at LL and 8 <sup>th</sup> to 12 <sup>th</sup> valley HL	$V_{REF}$ decreases	$V_{VLY7-11/8-12}$	–	37.5	–	
11 <sup>th</sup> to 7 <sup>th</sup> valley transition at LL and 12 <sup>th</sup> to 8 <sup>th</sup> valley HL	$V_{REF}$ increases	$V_{VLY11-7/12-8}$	–	50.0	–	
11 <sup>th</sup> to 13 <sup>th</sup> valley transition at LL and 12 <sup>th</sup> to 15 <sup>th</sup> valley HL	$V_{REF}$ decreases	$V_{VLY11-13/12-15}$	–	15.0	–	
13 <sup>th</sup> to 11 <sup>th</sup> valley transition at LL and 15 <sup>th</sup> to 12 <sup>th</sup> valley HL	$V_{REF}$ increases	$V_{VLY13-11/15-12}$	–	20.0	–	
<b>SOFT-STAT PIN</b>						
SS pin voltage for zero output current (enable)		$V_{SST(EN)}$	0.66	0.7	0.74	V
SS pin voltage for 100% of output current		$V_{SST100}$	2.25	2.45	2.65	V
Clamping voltage for SS pin		$V_{SST(CLP)}$	–	7.8	–	V
Soft-start current source		$I_{SST}$	8.5	10	11.5	$\mu\text{A}$
Pre-charge current source	$V_{SST} < V_{SST(EN)}$	$I_{SST(pre)}$	–	100	–	$\mu\text{A}$
<b>THERMAL FOLD-BACK AND OVP</b>						
SD pin voltage at which thermal fold-back starts		$V_{TF(start)}$	0.9	1	1.2	V
SD pin voltage at which thermal fold-back stops ( $I_{out} = 50\% I_{out(nom)}$ )		$V_{TF(stop)}$	0.64	0.68	0.72	V
Reference current for direct connection of an NTC (Note 5)		$I_{OTP(REF)}$	80	85	90	$\mu\text{A}$
Fault detection level for OTP (Note 5)	$V_{SD}$ decreasing	$V_{OTP(off)}$	0.47	0.5	0.53	V
SD pin level at which controller re-start switching after OTP detection	$V_{SD}$ increasing	$V_{OTP(on)}$	0.64	0.68	0.72	V
Timer duration after which the controller is allowed to start pulsing (Note 5)		$t_{OTP(start)}$	180	–	300	$\mu\text{s}$
Clamped voltage (SD pin left open)	SD pin open	$V_{SD(clamp)}$	1.13	1.35	1.57	V
Clamp series resistor		$R_{SD(clamp)}$	–	1.6	–	$\text{k}\Omega$
SD pin detection level for OVP	$V_{SD}$ increasing	$V_{OVP}$	2.35	2.5	2.65	V
Delay before OVP or OTP confirmation (OVP and OTP)		$T_{SD(delay)}$	15	30	45	$\mu\text{s}$
<b>THERMAL SHUTDOWN</b>						
Thermal Shutdown (Note 4)	Device switching ( $F_{SW}$ around 65 kHz)	$T_{SHDN}$	130	155	170	$^\circ\text{C}$
Thermal Shutdown Hysteresis (Note 4)		$T_{SHDN(HYS)}$	–	55	–	$^\circ\text{C}$
<b>BROWN-OUT</b>						
Brown-Out ON level (IC start pulsing)	$V_{SD}$ increasing	$V_{BO(on)}$	0.90	1	1.10	V
Brown-Out OFF level (IC shuts down)	$V_{SD}$ decreasing	$V_{BO(off)}$	0.85	0.9	0.95	V
BO comparators delay		$t_{BO(delay)}$	–	30	–	$\mu\text{s}$
Brown-Out blanking time		$t_{BO(blank)}$	35	50	65	ms
Brown-out pin bias current		$I_{BO(bias)}$	–250	–	250	nA

4. Guaranteed by design

5. OTP triggers when  $R_{NTC} = 4.7\text{ k}\Omega$

TYPICAL CHARACTERISTICS

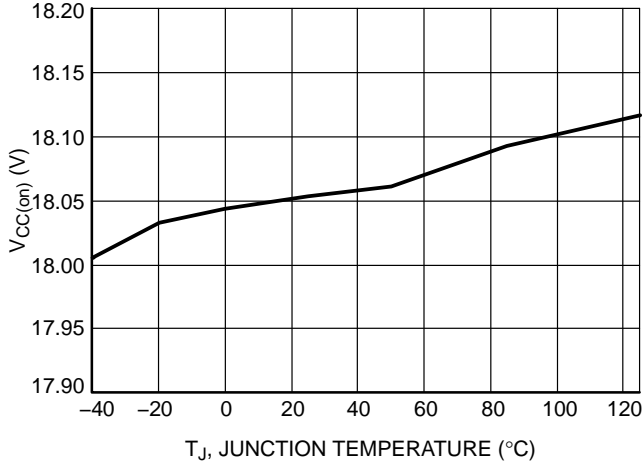

Figure 3.  $V_{CC(on)}$  vs. Junction Temperature

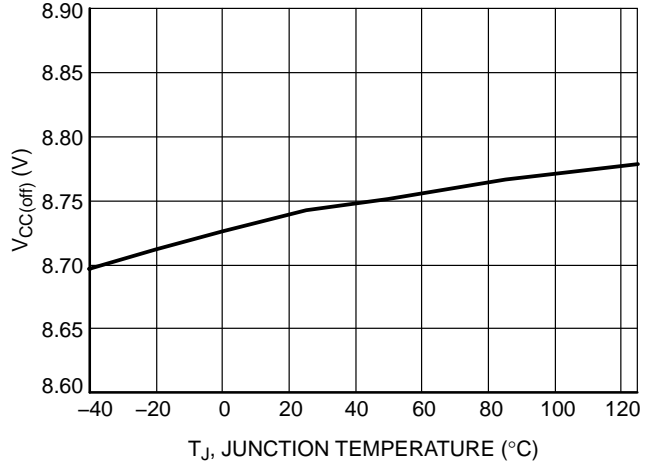

Figure 4.  $V_{CC(off)}$  vs. Junction Temperature

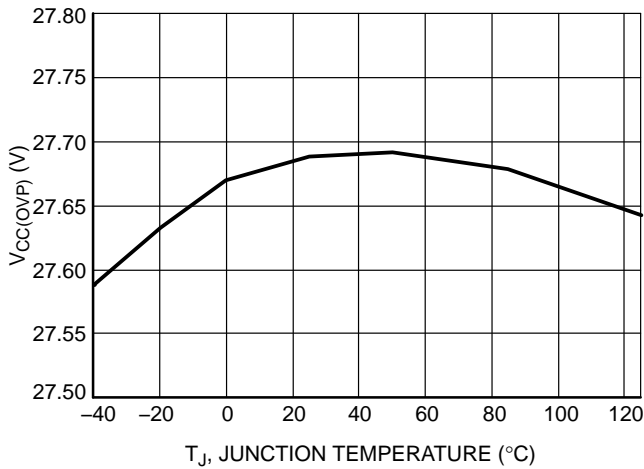

Figure 5.  $V_{CC(OVP)}$  vs. Junction Temperature

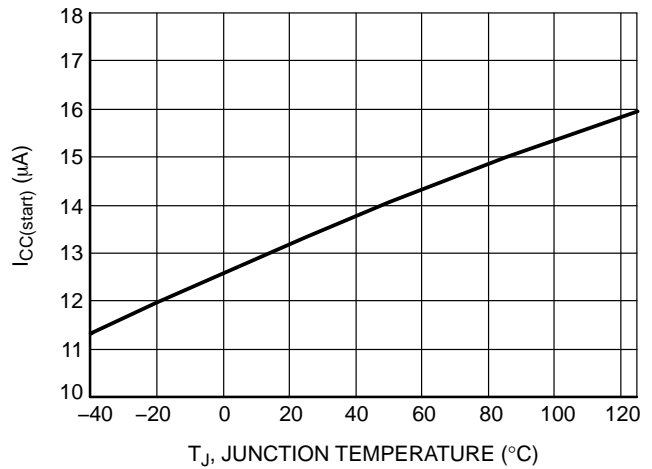

Figure 6.  $I_{CC(start)}$  vs. Junction Temperature

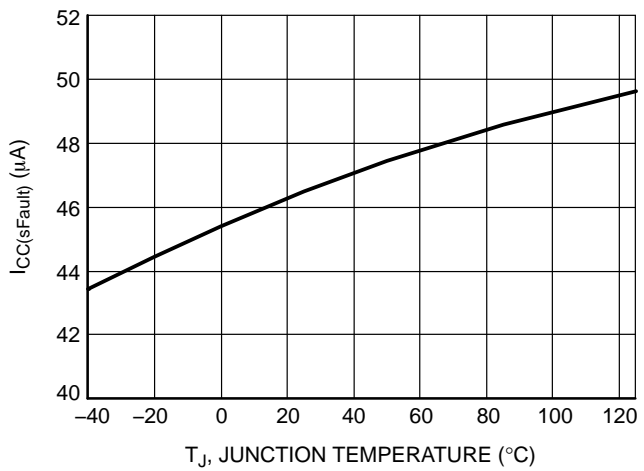

Figure 7.  $I_{CC(sFault)}$  vs. Junction Temperature

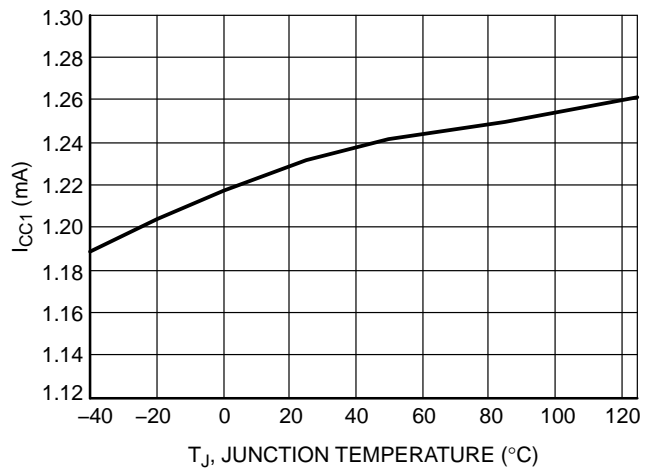

Figure 8.  $I_{CC1}$  vs. Junction Temperature



TYPICAL CHARACTERISTICS

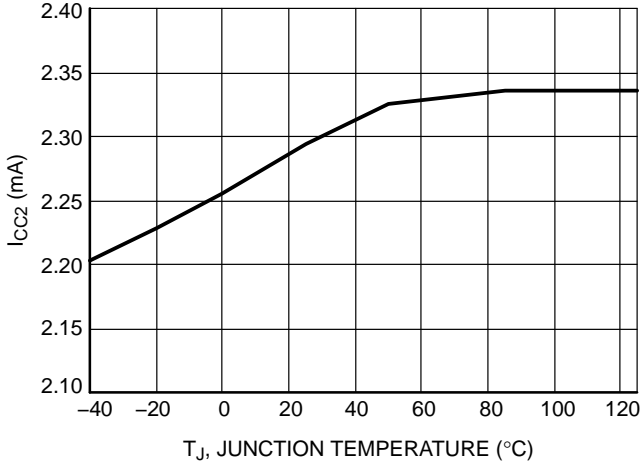

Figure 9.  $I_{CC2}$  vs. Junction Temperature

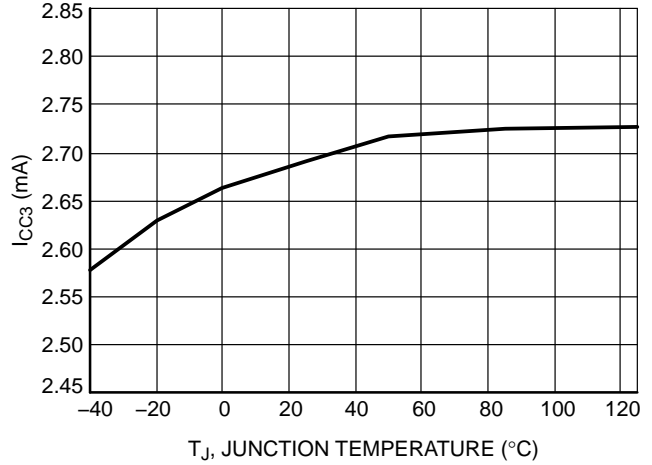

Figure 10.  $I_{CC3}$  vs. Junction Temperature

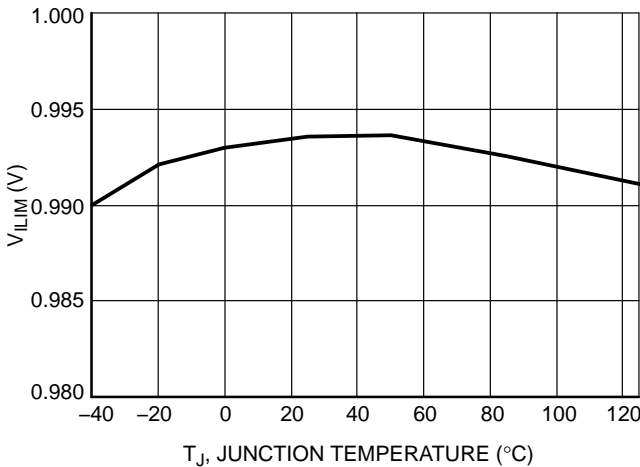

Figure 11.  $V_{ILIM}$  vs. Junction Temperature

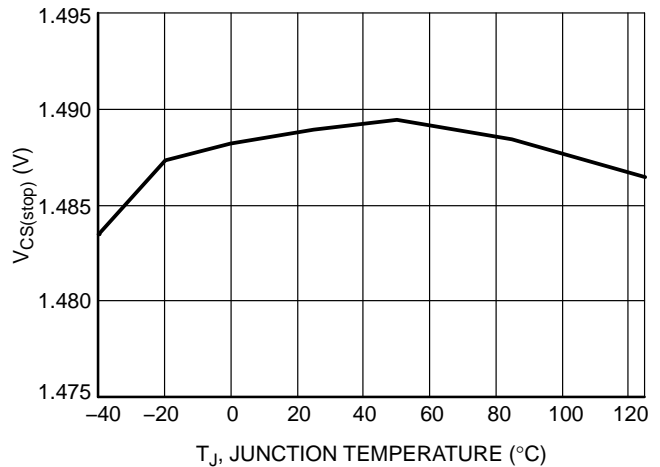

Figure 12.  $V_{CS(stop)}$  vs. Junction Temperature

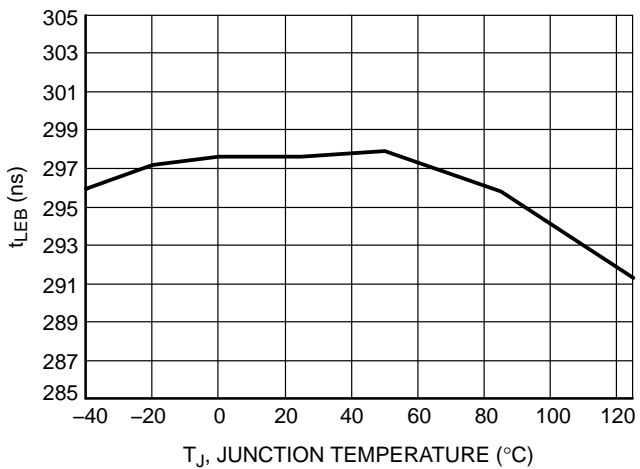

Figure 13.  $t_{LEB}$  vs. Junction Temperature

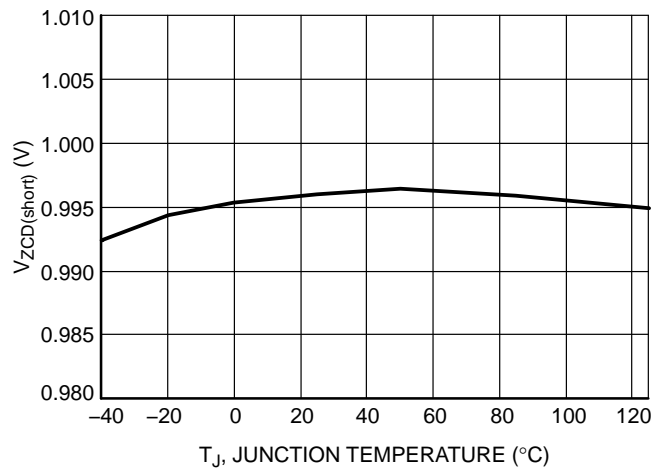

Figure 14.  $V_{ZCD(short)}$  vs. Junction Temperature

TYPICAL CHARACTERISTICS

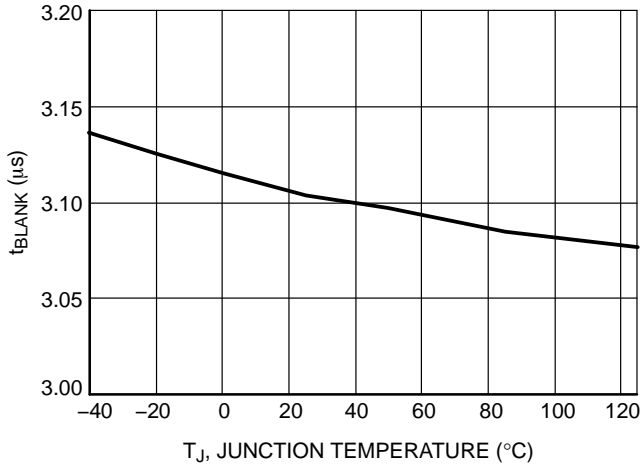

Figure 15.  $t_{BLANK}$  vs. Junction Temperature

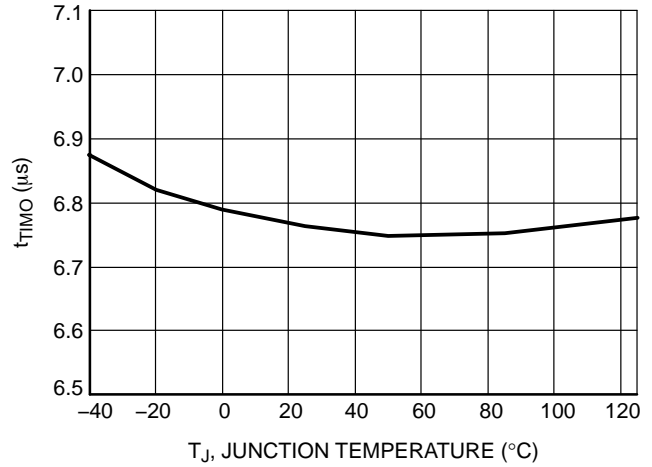

Figure 16.  $t_{TIMO}$  vs. Junction Temperature

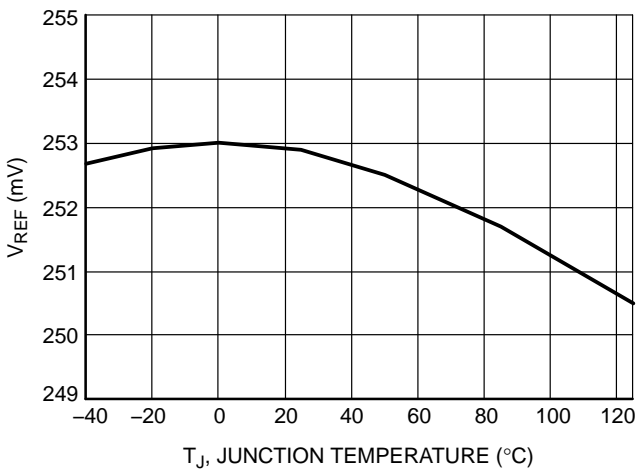

Figure 17.  $V_{REF}$  vs. Junction Temperature

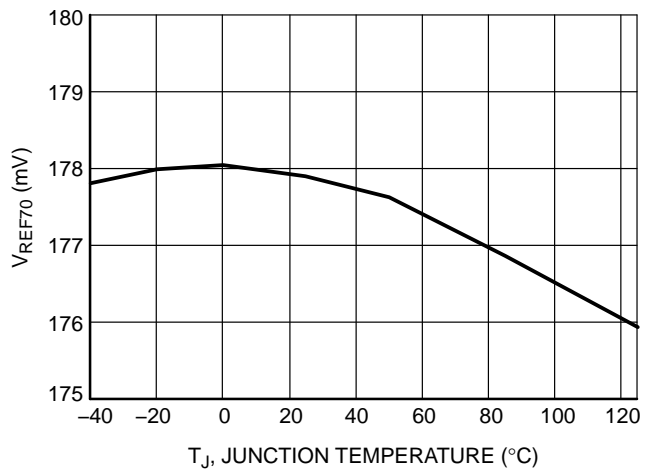

Figure 18.  $V_{REF70}$  vs. Junction Temperature

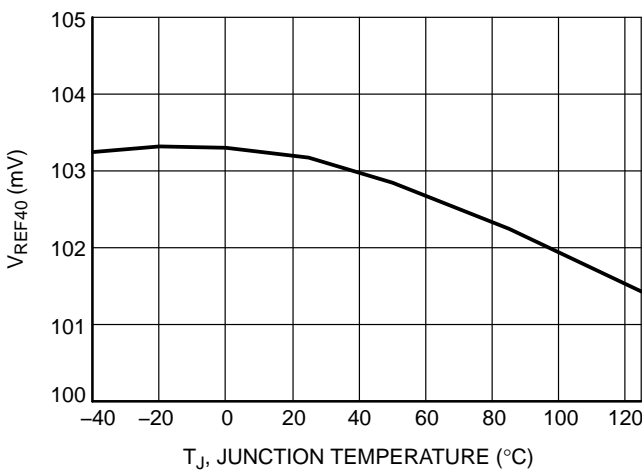

Figure 19.  $V_{REF40}$  vs. Junction Temperature

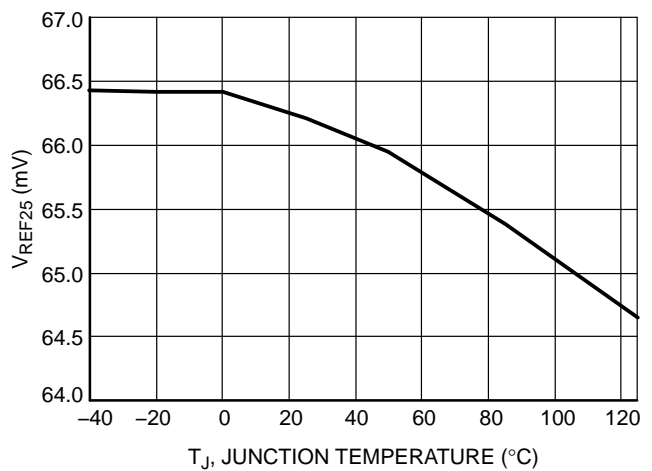

Figure 20.  $V_{REF25}$  vs. Junction Temperature

TYPICAL CHARACTERISTICS

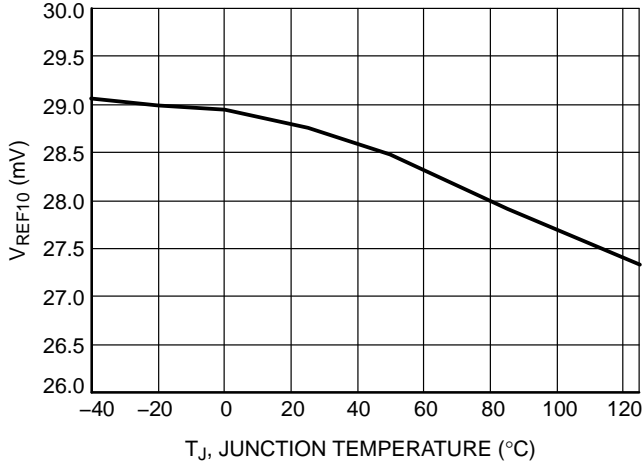

Figure 21. V<sub>REF10</sub> vs. Junction Temperature

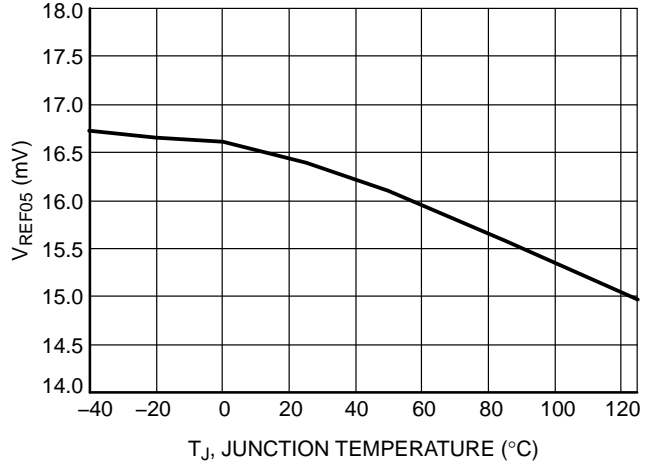

Figure 22. V<sub>REF05</sub> vs. Junction Temperature

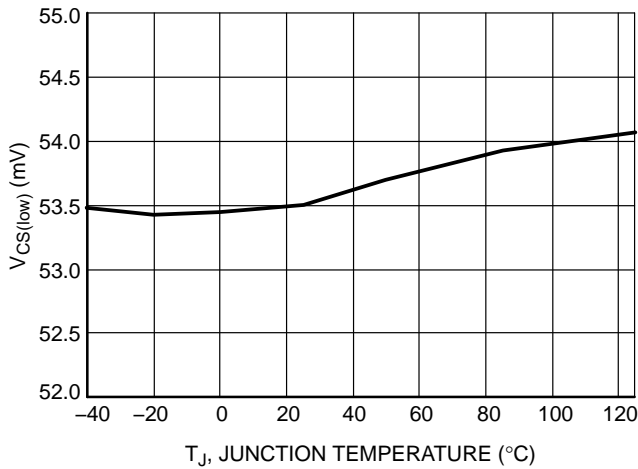

Figure 23. V<sub>CS(low)</sub> vs. Junction Temperature

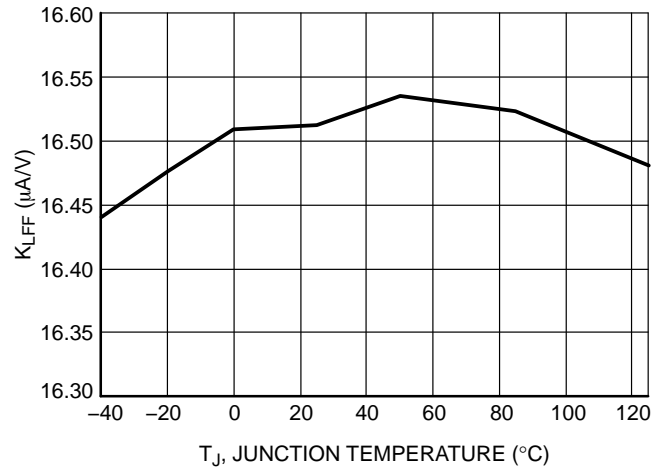

Figure 24. K<sub>LFF</sub> vs. Junction Temperature

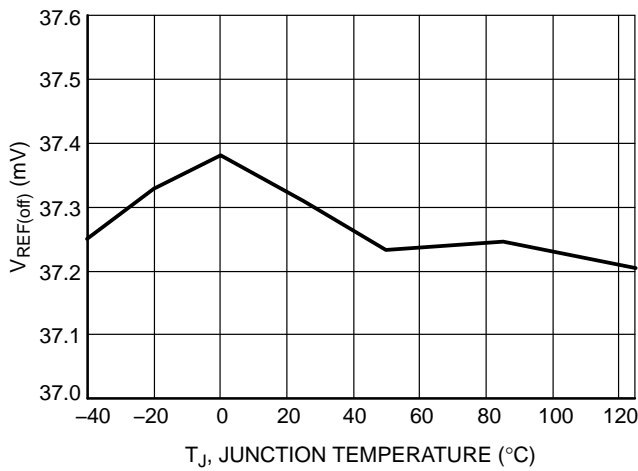

Figure 25. V<sub>REF(off)</sub> vs. Junction Temperature

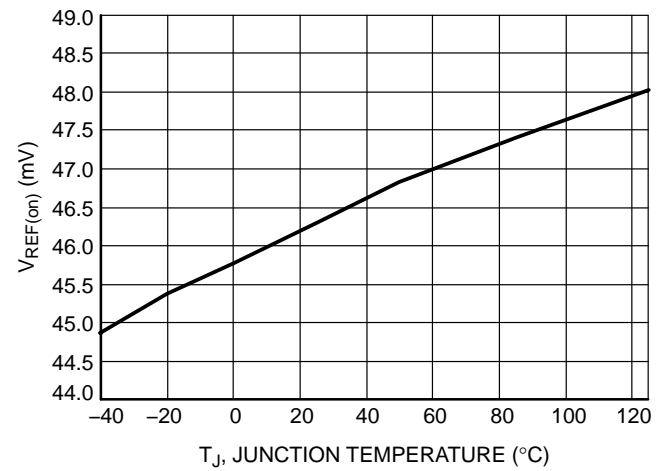

Figure 26. V<sub>REF(on)</sub> vs. Junction Temperature

TYPICAL CHARACTERISTICS

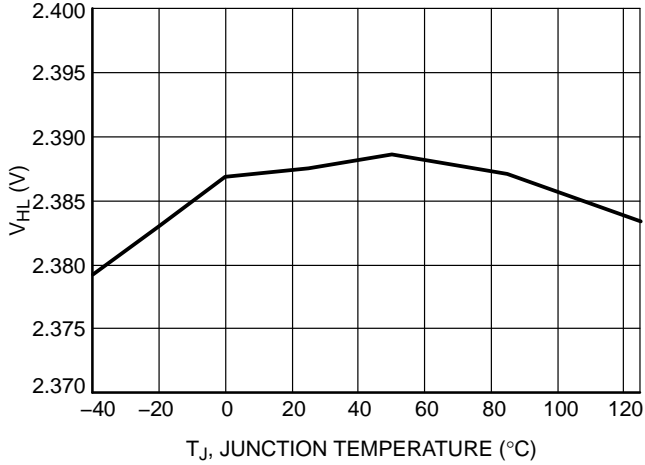

Figure 27.  $V_{HL}$  vs. Junction Temperature

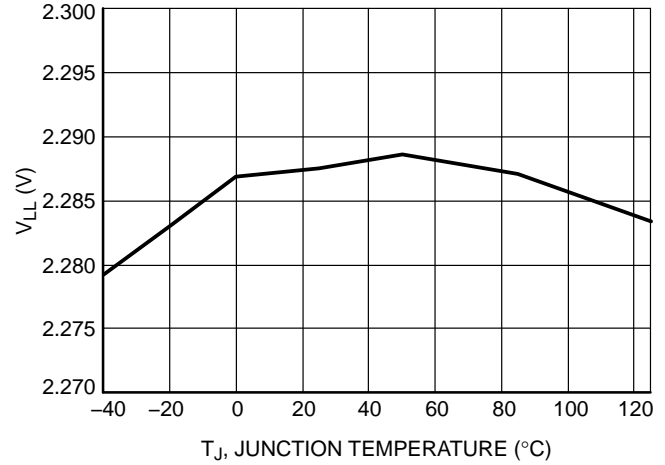

Figure 28.  $V_{LL}$  vs. Junction Temperature

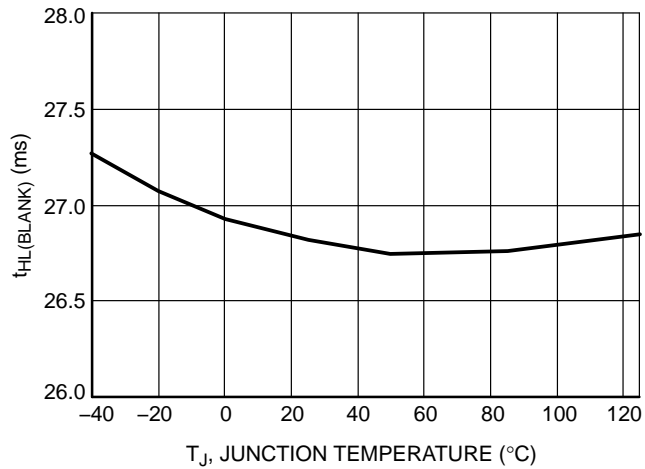

Figure 29.  $t_{HL(BLANK)}$  vs. Junction Temperature

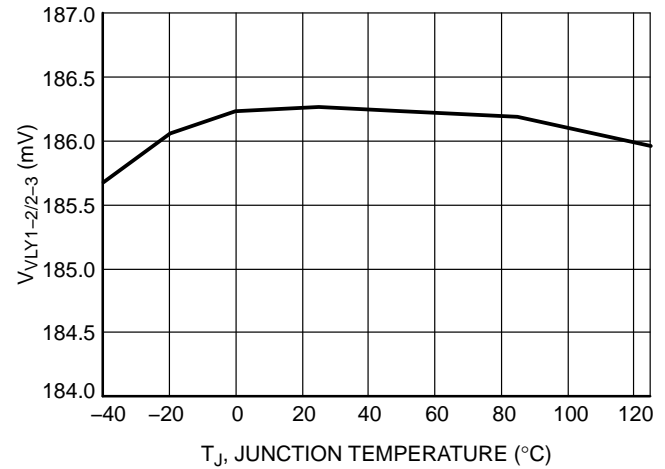

Figure 30.  $V_{VLY1-2/2-3}$  vs. Junction Temperature

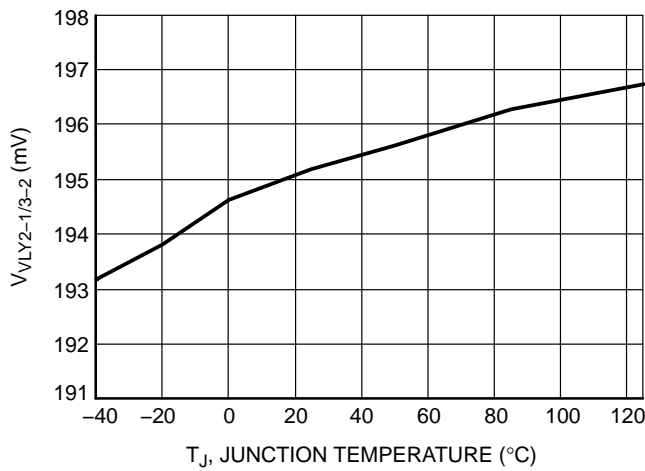

Figure 31.  $V_{VLY2-1/3-2}$  vs. Junction Temperature

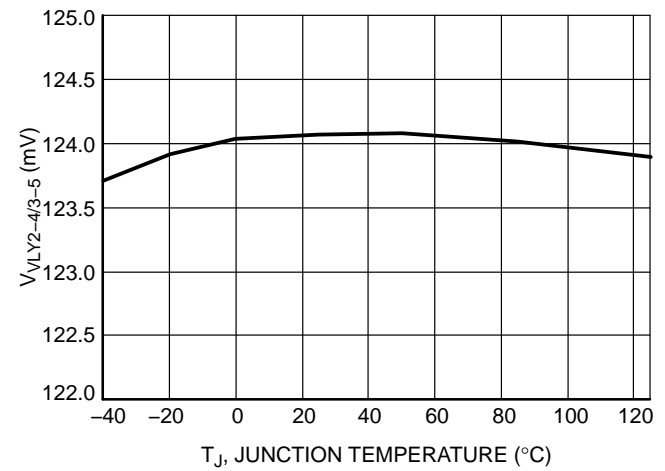

Figure 32.  $V_{VLY2-4/3-5}$  vs. Junction Temperature

TYPICAL CHARACTERISTICS

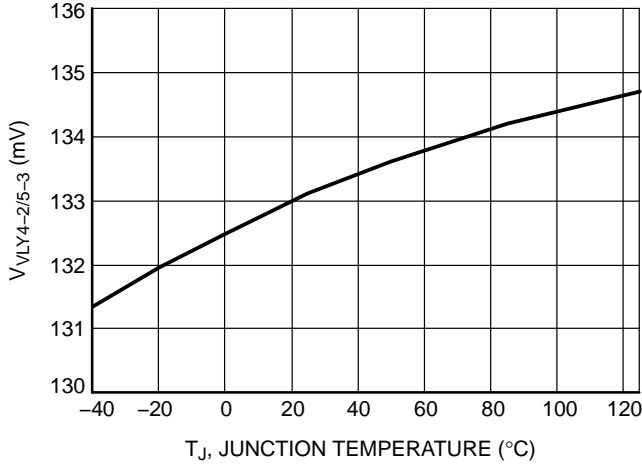

Figure 33.  $V_{VLY4-2/5-3}$  vs. Junction Temperature

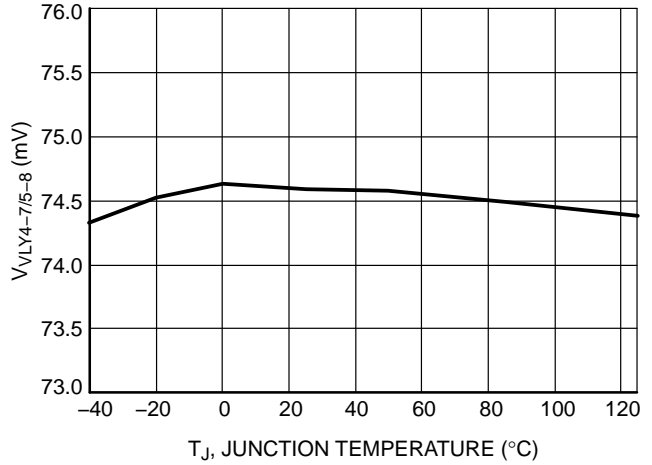

Figure 34.  $V_{VLY4-7/5-8}$  vs. Junction Temperature

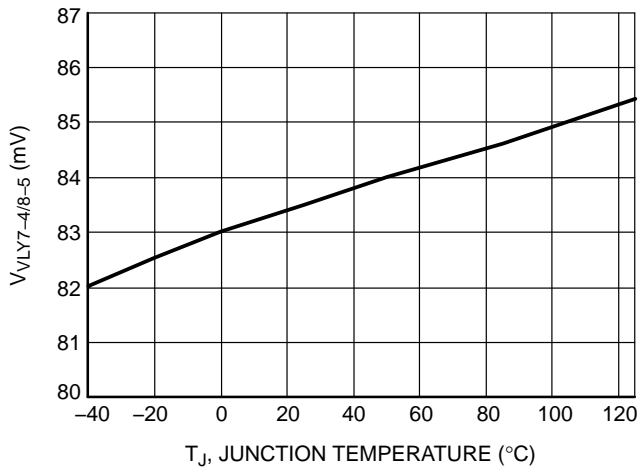

Figure 35.  $V_{VLY7-4/8-5}$  vs. Junction Temperature

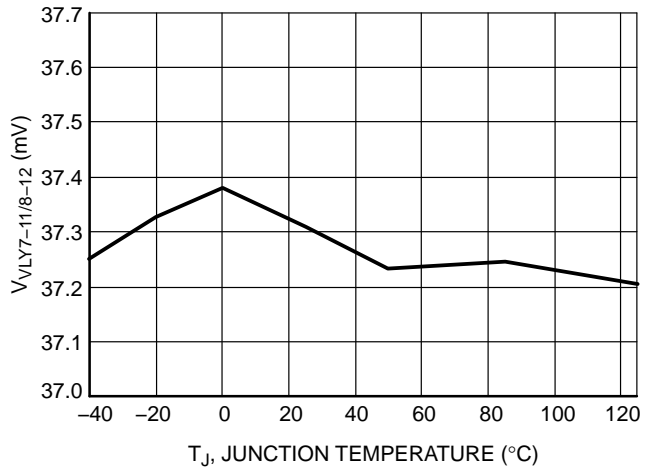

Figure 36.  $V_{VLY7-11/8-12}$  vs. Junction Temperature

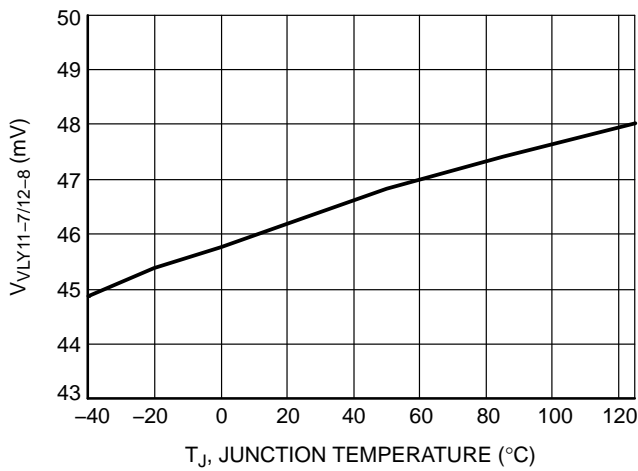

Figure 37.  $V_{VLY11-7/12-8}$  vs. Junction Temperature

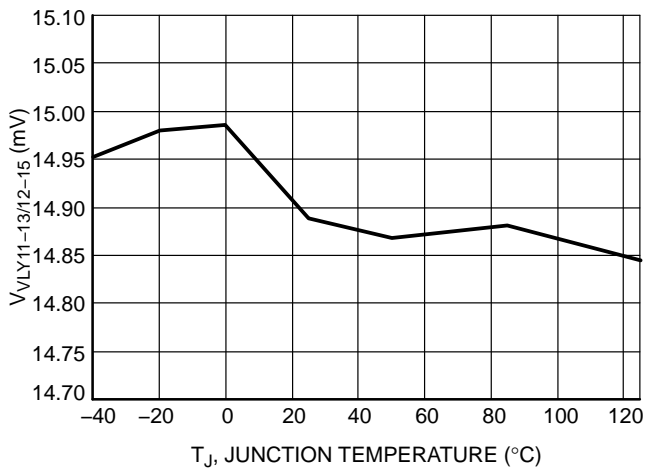

Figure 38.  $V_{VLY11-13/12-15}$  vs. Junction Temperature

TYPICAL CHARACTERISTICS

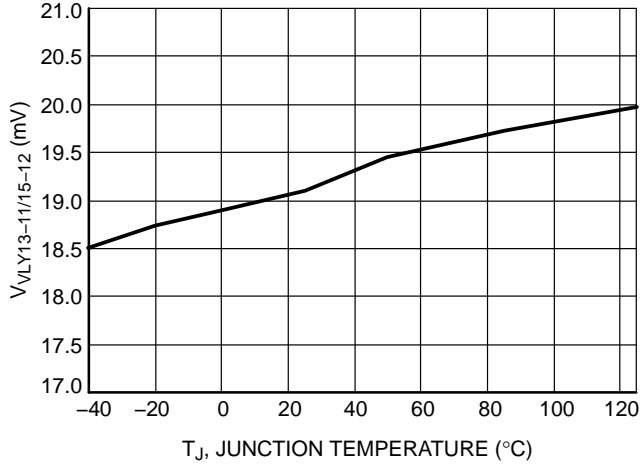

Figure 39.  $V_{VLY13-11/15-12}$  vs. Junction Temperature

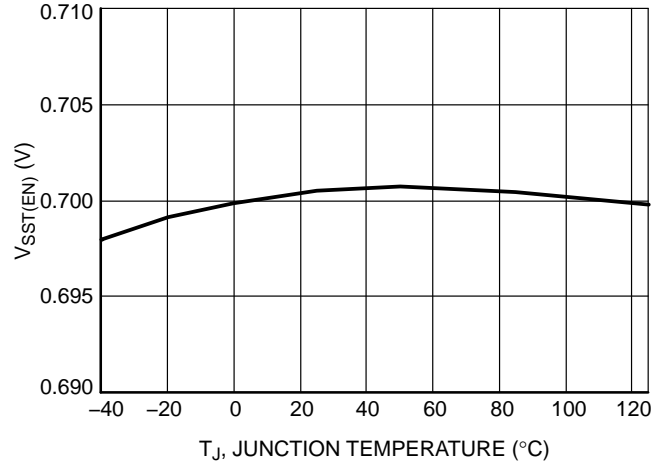

Figure 40.  $V_{SST(EN)}$  vs. Junction Temperature

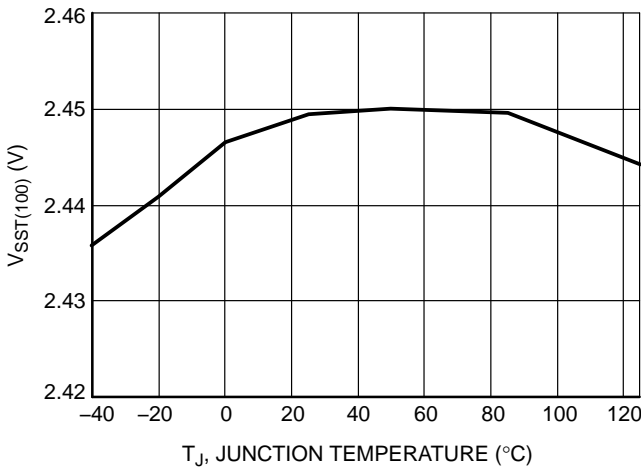

Figure 41.  $V_{SST(100)}$  vs. Junction Temperature

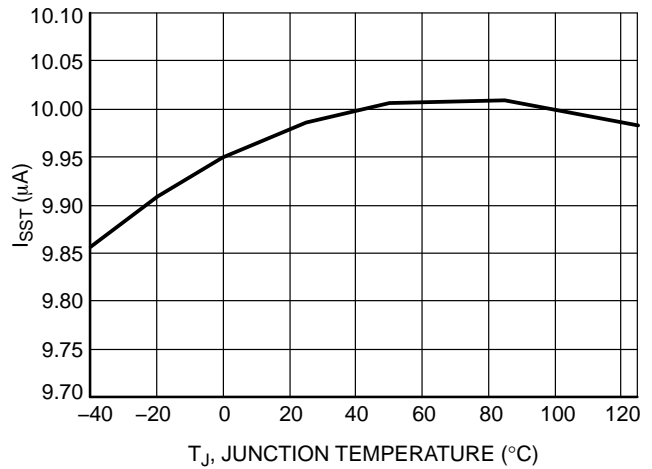

Figure 42.  $I_{SST}$  vs. Junction Temperature

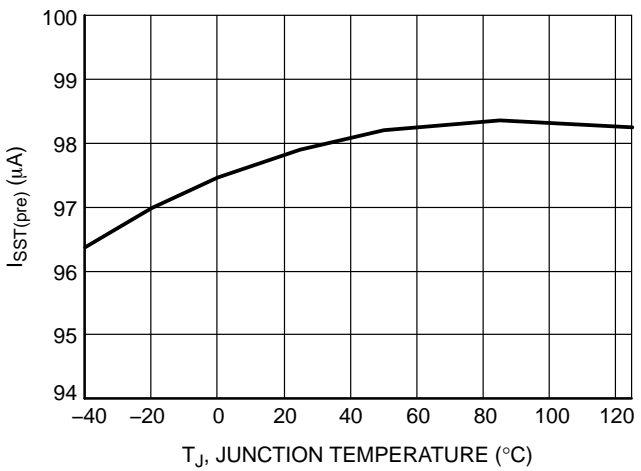

Figure 43.  $I_{SST(pre)}$  vs. Junction Temperature

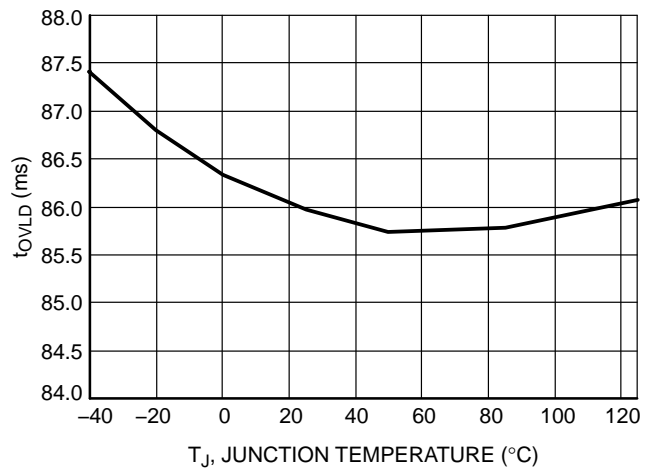

Figure 44.  $t_{OVLD}$  vs. Junction Temperature

TYPICAL CHARACTERISTICS

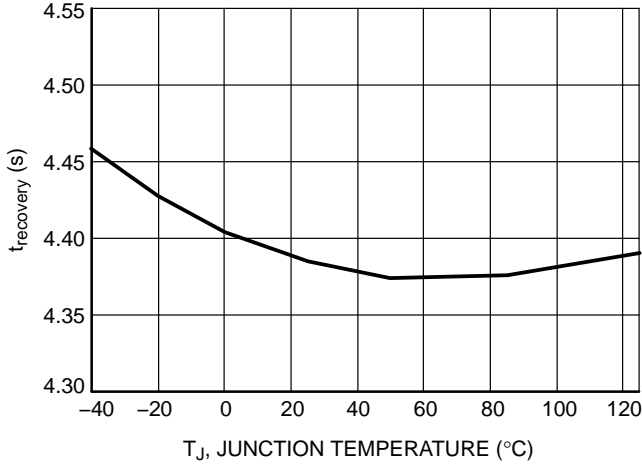

Figure 45.  $t_{\text{recovery}}$  vs. Junction Temperature

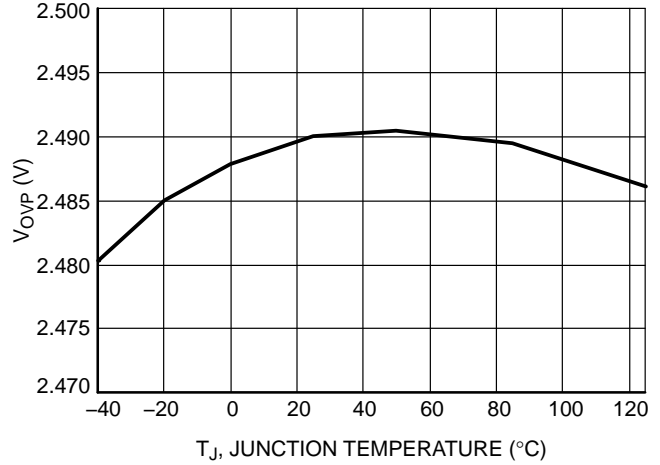

Figure 46.  $V_{\text{OVP}}$  vs. Junction Temperature

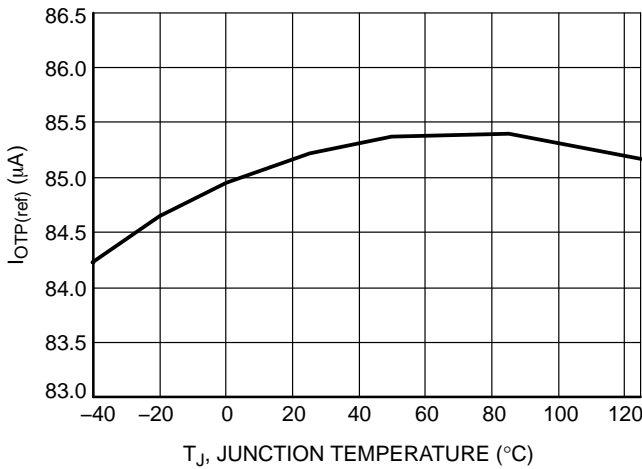

Figure 47.  $I_{\text{OTP(ref)}}$  vs. Junction Temperature

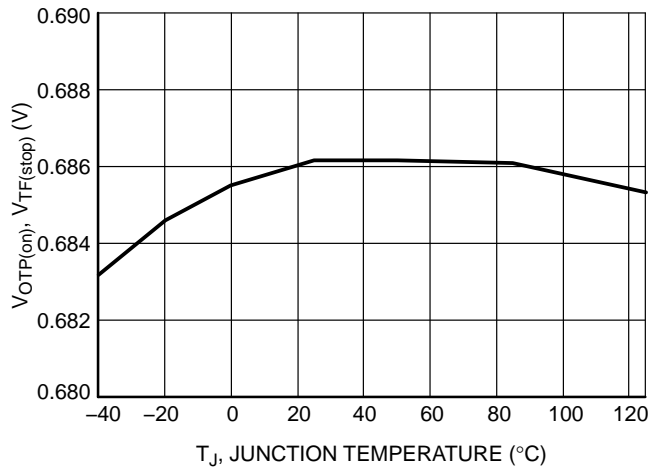

Figure 48.  $V_{\text{OTP(on)}}$ ,  $V_{\text{TF(stop)}}$  vs. Junction Temperature

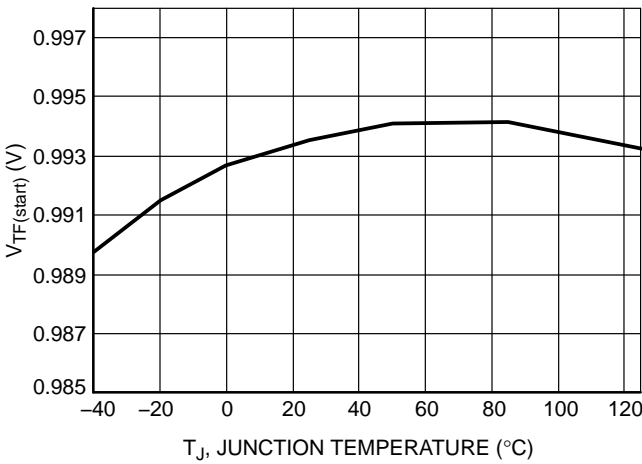

Figure 49.  $V_{\text{TF(start)}}$  vs. Junction Temperature

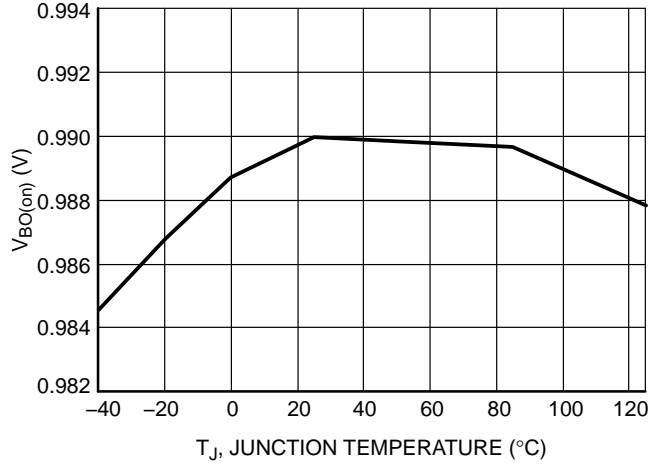
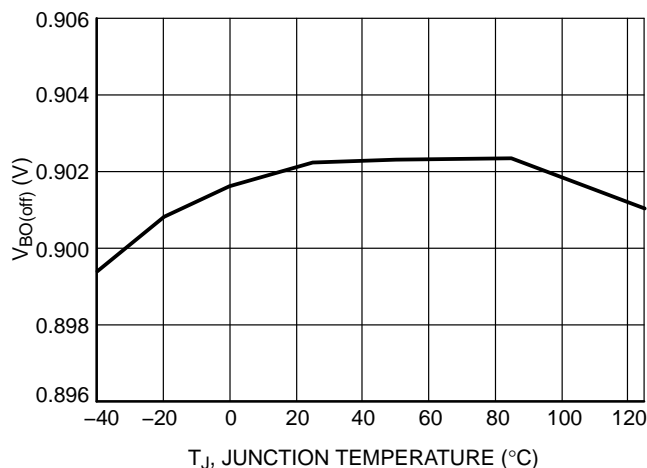
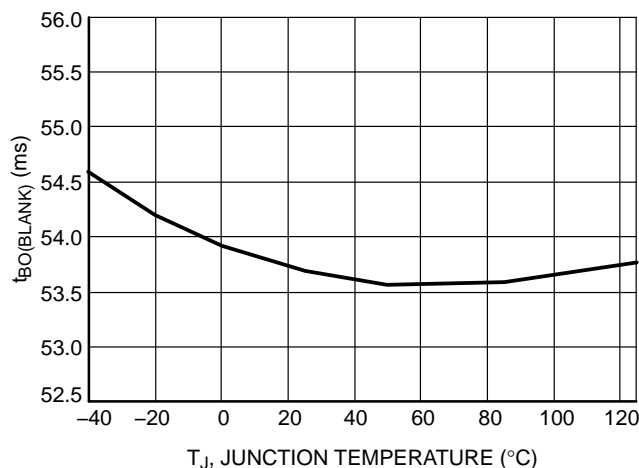

Figure 50.  $V_{\text{BO(on)}}$  vs. Junction Temperature

## TYPICAL CHARACTERISTICS

Figure 51.  $V_{BO(off)}$  vs. Junction TemperatureFigure 52.  $t_{BO(BLANK)}$  vs. Junction Temperature

## APPLICATION INFORMATION

The NCL30083 implements a current-mode architecture operating in quasi-resonant mode. Thanks to proprietary circuitry, the controller is able to accurately regulate the secondary side current of the flyback converter without using any opto-coupler or measuring directly the secondary side current.

- **Quasi-Resonance Current-Mode Operation:** implementing quasi-resonance operation in peak current-mode control, the NCL30083 optimizes the efficiency by switching in the valley of the MOSFET drain-source voltage. Thanks to a smart control algorithm, the controller locks-out in a selected valley and remains locked until the input voltage or the output current set point significantly changes.
- **Primary Side Constant Current Control:** thanks to a proprietary circuit, the controller is able to take into account the effect of the leakage inductance of the transformer and allow accurate control of the secondary side current.
- **Line Feed-forward:** compensation for possible variation of the output current caused by system slew rate variation.
- **Open LED protection:** if the voltage on the VCC pin exceeds an internal limit, the controller shuts down and waits 4 seconds before restarting pulsing.
- **Thermal Fold-back / Over Temperature / Over Voltage Protection:** by combining a dual threshold on the SD pin, the controller allows the direct connection of an NTC to ground plus a Zener diode to a monitored voltage. The temperature is monitored and the output current is linearly reduced in the event that the temperature exceeds a prescribed level. If the

temperature continues to increase, the current will be further reduced until the controller is stopped. The control will automatically restart if the temperature is reduced. This pin can implement a programmable OVP shutdown that can also auto-restart the device.

- **Brown-Out:** the controller includes a brown-out circuit which safely stops the controller in case the input voltage is too low. The device will automatically restart if the line recovers.
- **Cycle-by-cycle peak current limit:** when the current sense voltage exceeds the internal threshold  $V_{ILIM}$ , the MOSFET is turned off for the rest of the switching cycle.
- **Winding Short-Circuit Protection:** an additional comparator with a short LEB filter ( $t_{BCS}$ ) senses the CS signal and stops the controller if  $V_{CS}$  reaches  $1.5 \times V_{ILIM}$ . For noise immunity reasons, this comparator is enabled only during the main LEB duration  $t_{LEB}$ .
- **Output Short-circuit protection:** If a very low voltage is applied on ZCD pin for 90 ms (nominal), the controllers assume that the output or the ZCD pin is shorted to ground and enters shutdown. The auto-restart version (B suffix) waits 4 seconds, then the controller restarts switching. In the latched version (A suffix), the controller is latched as long as  $V_{CC}$  stays above the  $V_{CC(reset)}$  threshold.
- **Soft-start:** The soft-start pin can be used to slowly increase the output current at startup and provide a smooth turn-on of the LED light.
- **Step dimming:** Each time the IC detects a brown-out condition, the output current is decreased by discrete steps.



**Constant Current Control**

Figure 54 portrays the primary and secondary current of a flyback converter in discontinuous conduction mode (DCM). Figure 53 shows the basic circuit of a flyback converter.

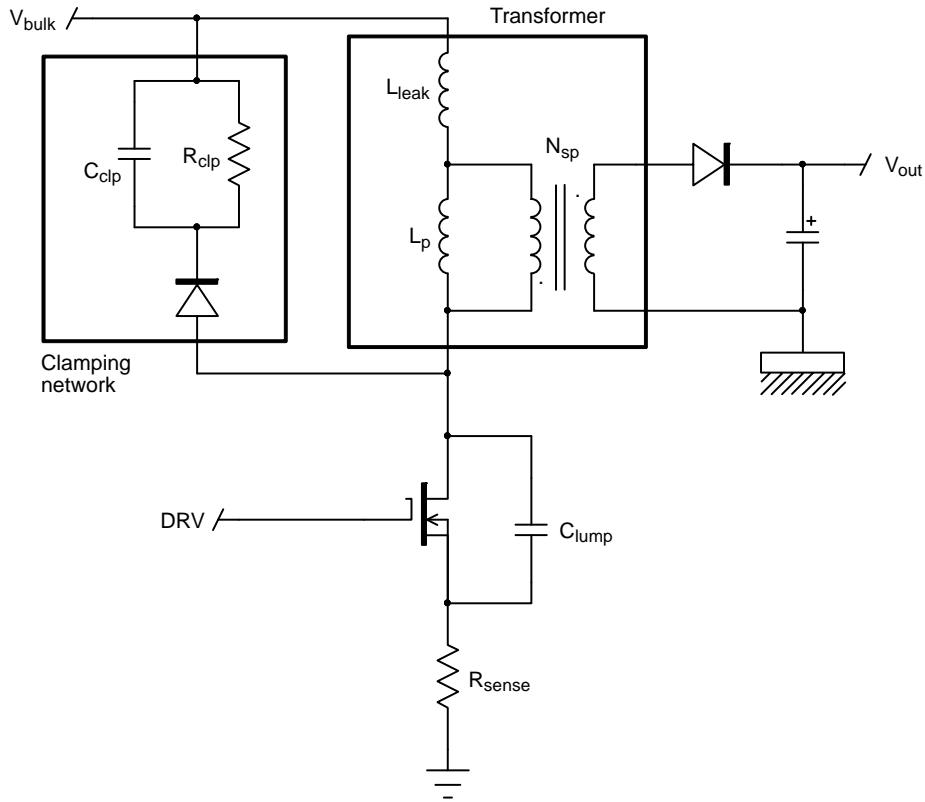

**Figure 53. Basic Flyback Converter Schematic**

During the on-time of the MOSFET, the bulk voltage  $V_{bulk}$  is applied to the magnetizing and leakage inductors  $L_p$  and  $L_{leak}$  and the current ramps up.

When the MOSFET is turned-off, the inductor current first charges  $C_{lump}$ . The output diode is off until the voltage across  $L_p$  reverses and reaches:

$$N_{sp}(V_{out} + V_f) \quad (eq. 1)$$

The output diode current increase is limited by the leakage inductor. As a consequence, the secondary peak current is reduced:

$$I_{D,pk} < \frac{I_{L,pk}}{N_{sp}} \quad (eq. 2)$$

The diode current reaches its peak when the leakage inductor is reset. Thus, in order to accurately regulate the output current, we need to take into account the leakage inductor current. This is accomplished by sensing the clamping network current. Practically, a node of the clamp capacitor is connected to  $R_{sense}$  instead of the bulk voltage  $V_{bulk}$ . Then, by reading the voltage on the CS pin, we have an image of the primary current (red curve in Figure 54).

When the diode conducts, the secondary current decreases linearly from  $I_{D,pk}$  to zero. When the diode current has turned off, the drain voltage begins to oscillate because of the resonating network formed by the inductors ( $L_p + L_{leak}$ ) and the lump capacitor. This voltage is reflected on the auxiliary winding wired in flyback mode. Thus, by looking at the auxiliary winding voltage, we can detect the end of the conduction time of secondary diode. The constant current control block picks up the leakage inductor current, the end of conduction of the output rectifier and controls the drain current to maintain the output current constant.

We have:

$$I_{out} = \frac{V_{REF}}{2N_{sp}R_{sense}} \quad (eq. 3)$$

The output current value is set by choosing the sense resistor:

$$R_{sense} = \frac{V_{ref}}{2N_{sp}I_{out}} \quad (eq. 4)$$

From Equation 3, the first key point is that the output current is independent of the inductor value. Moreover, the leakage inductance does not influence the output current value as the reset time is taken into account by the controller.

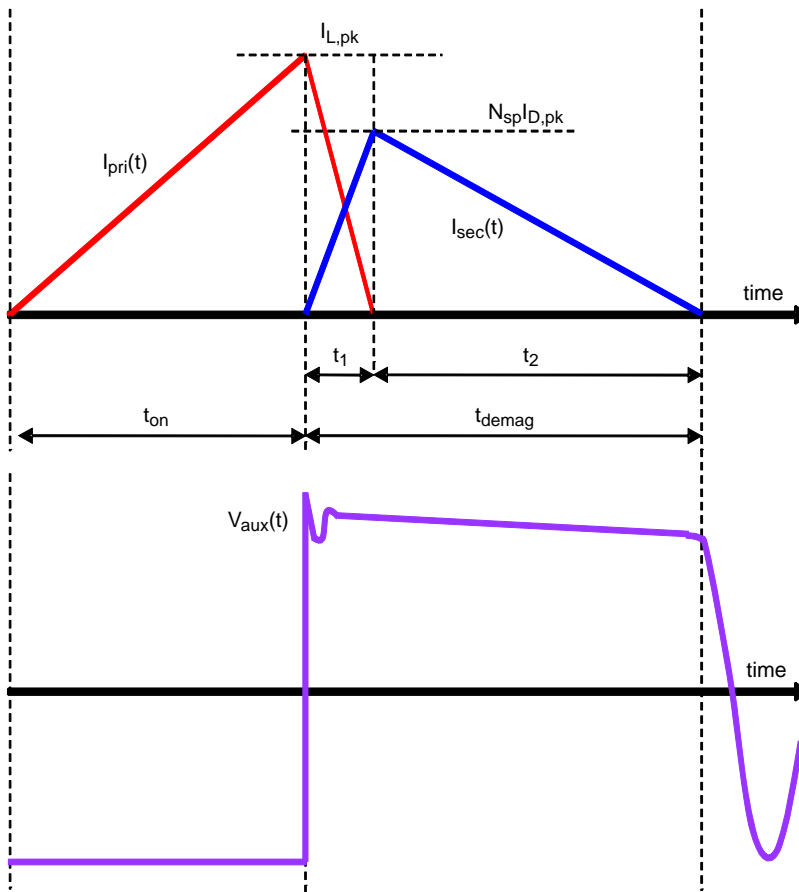

Figure 54. Flyback Currents and Auxiliary Winding Voltage in DCM

**Internal Soft-Start**

At startup or after recovering from a fault, there is a small internal soft-start of 40  $\mu$ s.

In addition, during startup, as the output voltage is zero volts, the demagnetization time is long and the constant

current control block will slowly increase the peak current towards its nominal value as the output voltage grows. Figure 55 shows a soft-start simulation example for a 9 W LED power supply.

# NCL30083

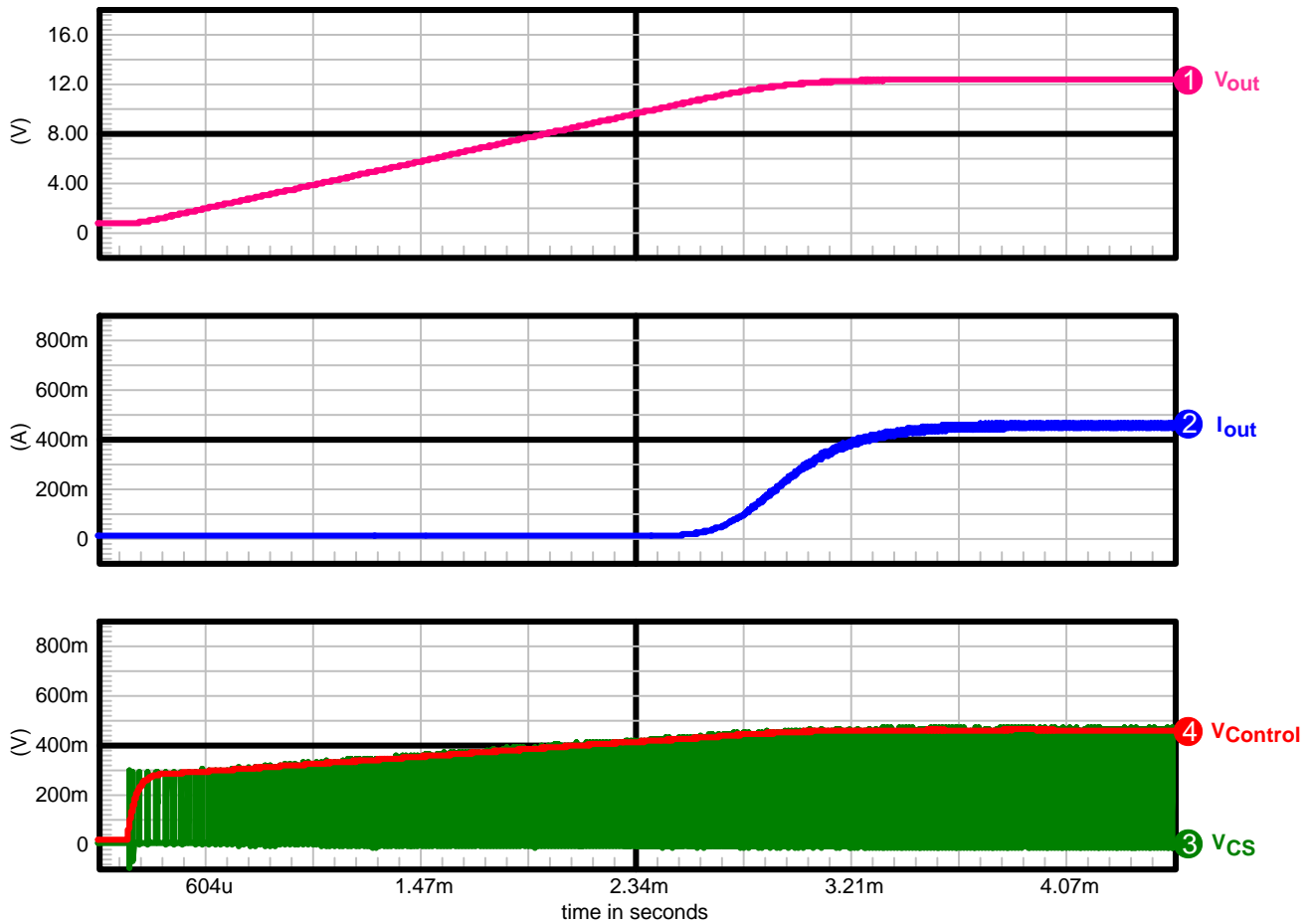

Figure 55. Startup Simulation Showing the Natural Soft-start

## Cycle-by-Cycle Current Limit

When the current sense voltage exceeds the internal threshold  $V_{ILIM}$ , the MOSFET is turned off for the rest of the switching cycle (Figure 56).

## Winding and Output Diode Short-Circuit Protection

In parallel with the cycle-by-cycle sensing of the CS pin, another comparator with a reduced LEB ( $t_{BCS}$ ) and a higher threshold (1.5 V typical) is able to sense winding short-circuit and immediately stops the DRV pulses. The controller goes into auto-recovery mode in version B.

In version A, the controller is latched. In latch mode, the DRV pulses stop and VCC ramps up and down. The circuit un-latches when VCC pin voltage drops below  $V_{CC(reset)}$  threshold.

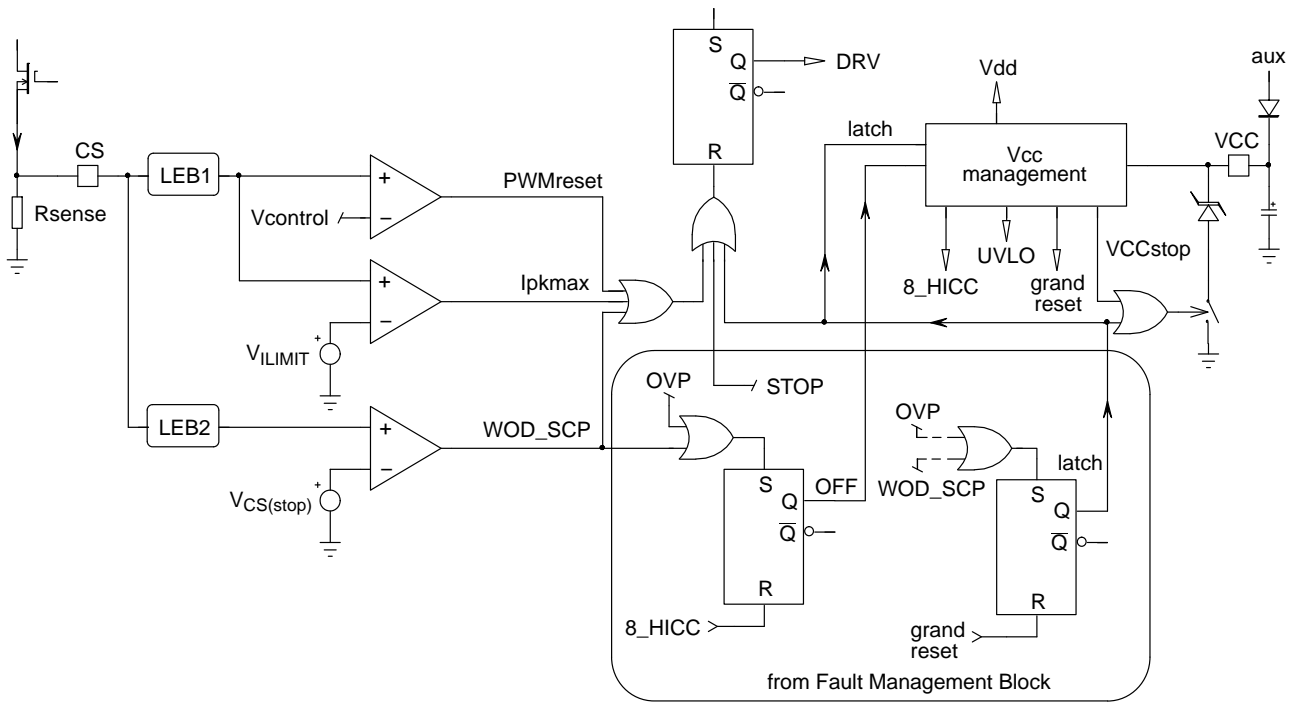

Figure 56. Winding Short Circuit Protection, Max. Peak Current Limit Circuits

**Thermal Fold-back and Over Voltage / Over Temperature Protection**

The thermal fold-back circuit reduces the current in the LED string when the ambient temperature exceeds a set point. The current is gradually reduced to 50% of its nominal value if the temperature continues to rise. (Figure 58). The thermal foldback starting temperature depends on the Negative Coefficient Temperature (NTC) resistor chosen by the power supply designer.

Indeed, the SD pin allows the direct connection of an NTC to sense the ambient temperature. When the SD pin voltage  $V_{SD}$  drops below  $V_{TF(start)}$ , the internal reference for the constant current control  $V_{REF}$  is decreased proportionally to  $V_{SD}$ . When  $V_{SD}$  reaches  $V_{TF(stop)}$ ,  $V_{REF}$  is clamped to  $V_{REF50}$ , corresponding to 50% of the nominal output current.

If  $V_{SD}$  drops below  $V_{OTP}$ , the controller enters into the auto-recovery fault mode for version B, meaning that the 4-s timer is activated. The controller will re-start switching after the 4-s timer has elapsed and when  $V_{SD} > V_{OTP(on)}$  to provide some temperature hysteresis (around 10°C).

For version A, this protection is latched: reset occurs when  $V_{CC} < V_{CC(reset)}$ .

The thermal fold-back and OTP thresholds correspond roughly to the following resistances:

- Thermal fold-back starts when  $R_{NTC} \leq 11.76 \text{ k}\Omega$ .
- Thermal fold-back stops when  $R_{NTC} \leq 8.24 \text{ k}\Omega$ .
- OTP triggers when  $R_{NTC} \leq 5.88 \text{ k}\Omega$ .
- OTP is removed when  $R_{NTC} \geq 8.24 \text{ k}\Omega$ .

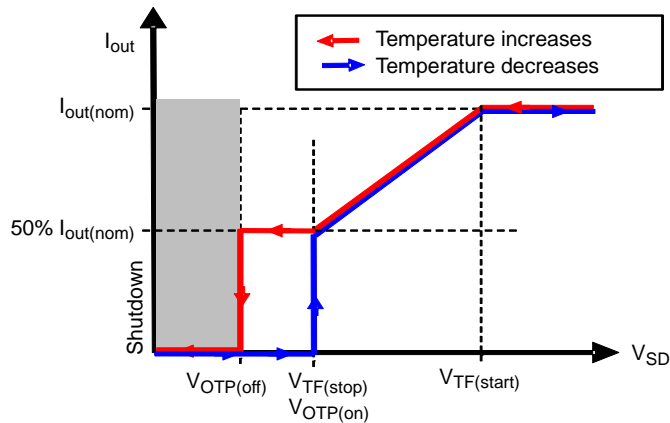
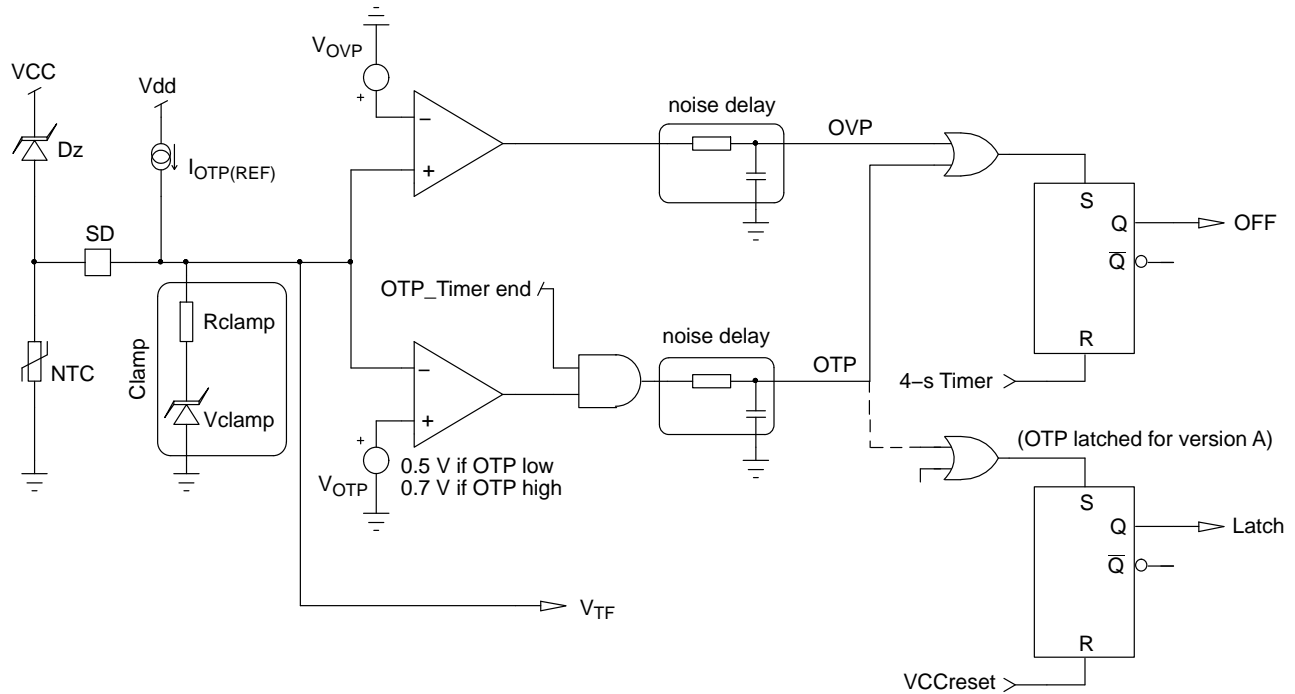

Figure 57. Output Current Reduction versus SD Pin Voltage

## NCL30083

At startup, when  $V_{CC}$  reaches  $V_{CC(on)}$ , the controller is not allowed to start pulsing for at least  $180\ \mu\text{s}$  in order to allow the SD pin voltage to reach its nominal value if a

filtering capacitor is connected to the SD pin. This is to avoid flickering of the LED light in case of over temperature.



**Figure 58. Thermal Fold-back and OVP/OTP Circuitry**

In case of over voltage, the Zener diode starts to conduct and inject current inside the internal clamp resistor  $R_{clamp}$  thus causing the pin SD voltage to increase. When this

voltage reaches the OVP threshold (2.5 V typ.), the controller shuts-down and waits for at least 4 seconds before restarting switching.

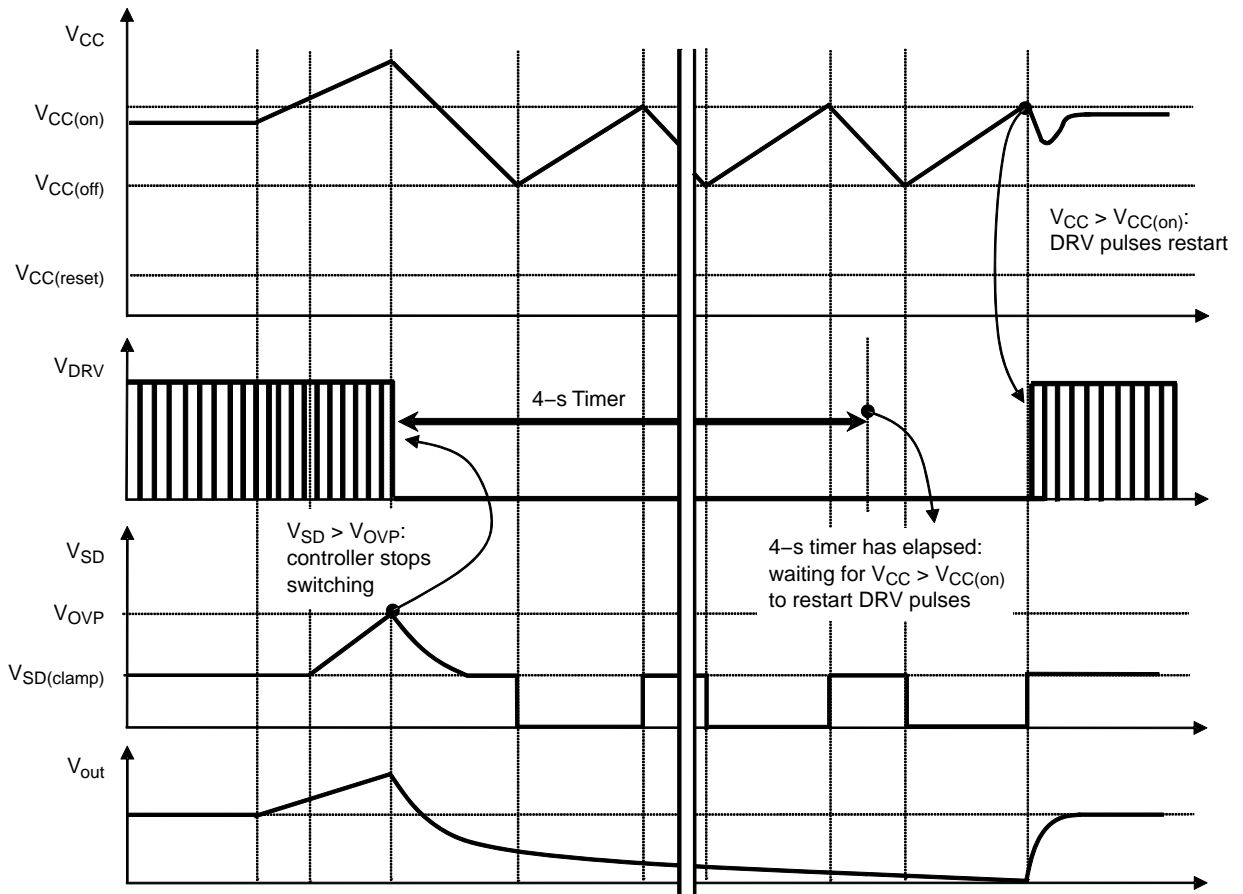

Figure 59. OVP with SD Pin Chronograms

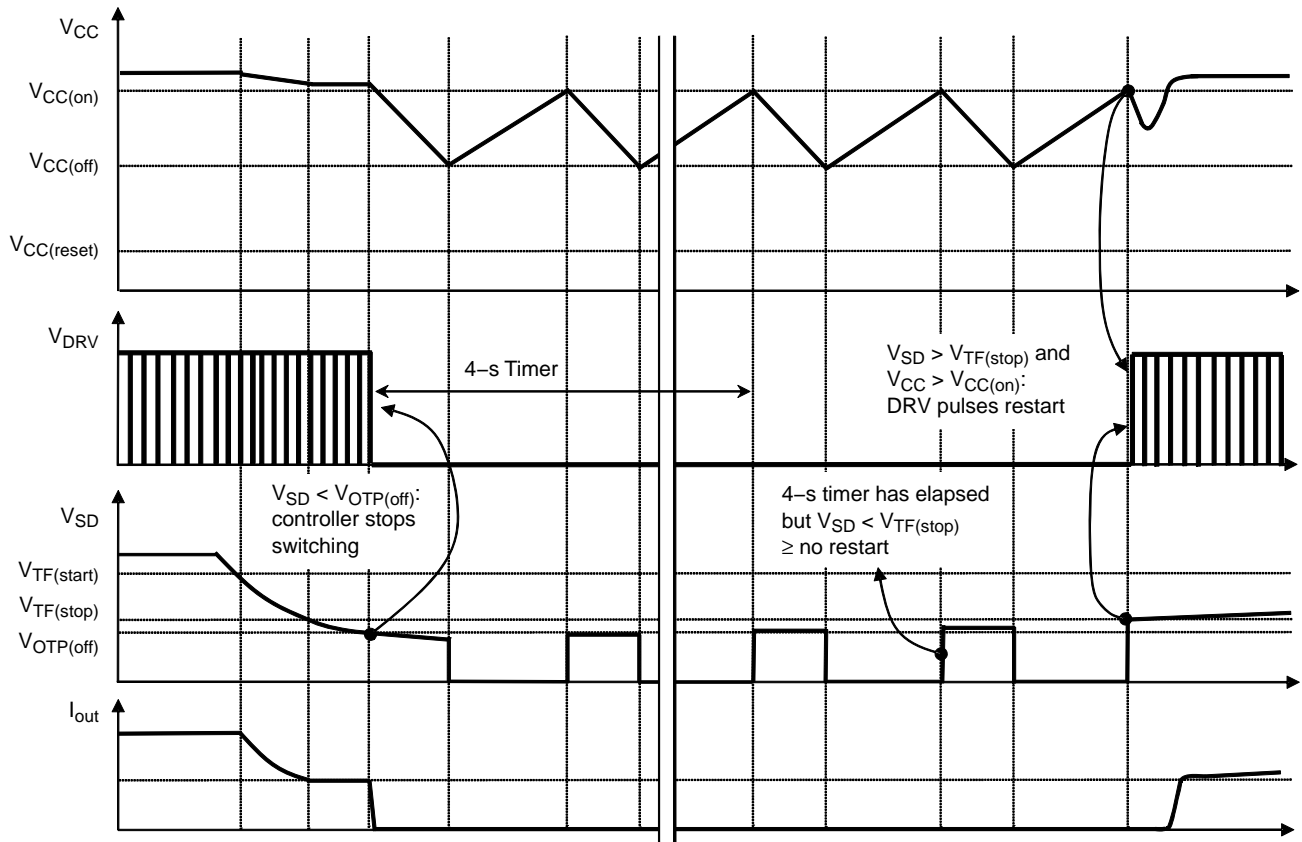

Figure 60. Thermal Fold-back / OTP Chronograms

**Soft-Start**

The NCL30083 provides a soft-start pin allowing increasing slowly the LEDs light at startup. An internal current source  $I_{SSST}$  charges the soft-start capacitor. The generated voltage ramp directly controls the amount of current flowing in the LEDs.

At startup, if there are no faults (except “Enable\_b” high), an internal pre-charging current source  $I_{SSST(pre)}$  connected

in parallel with  $I_{SSST}$  charges the soft-start capacitor until it reaches the  $V_{SSST(EN)}$  threshold. After that,  $I_{SSST(pre)}$  is turned off and the soft-start capacitor keep on charging with the soft-start current source  $I_{SSST}$ .

When a fault is detected, the soft-start pin is discharged down to  $V_{SSST(EN)}$  to provide a clean soft-start when the fault is removed.

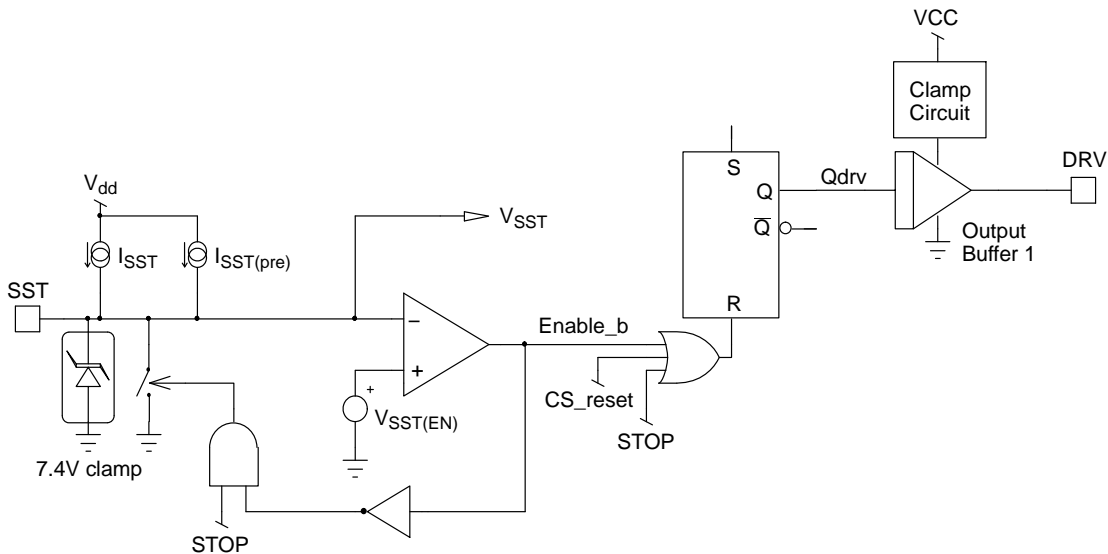

Figure 61. Soft-start Pin Bloc Diagram

**Step Dimming**

The step dimming function decreases the output current from 100% to 5% of its nominal value in discrete steps. There are 5 steps in total. Table 4 shows the different steps value and the corresponding output current set-point. Each time a brown-out is detected, the output current is decreased by decreasing the reference voltage  $V_{REF}$  setting the output current value.

When the 5% dimming step is reached, if a brown-out event occurs, the controller restarts at 100% of the output current.

**Table 4. DIMMING STEPS**

Dimming Step	$I_{out}$	Perceived Light
ON	100%	100%
1	70%	84%
2	40%	63%
3	25%	50%
4	10%	32%
5	5%	17%

Note:

The power supply designer must ensure that  $V_{CC}$  stays high enough when the light is turned-off to let the controller memorize the dimming step state.

The power supply designer should use a split  $V_{CC}$  circuit for step dimming with a capacitor allowing providing enough  $V_{CC}$  for 1 s (47  $\mu$ F to 100  $\mu$ F capacitor).

The step dimming state is memorized by the controller until  $V_{CC}$  crosses  $V_{CC(reset)}$ .

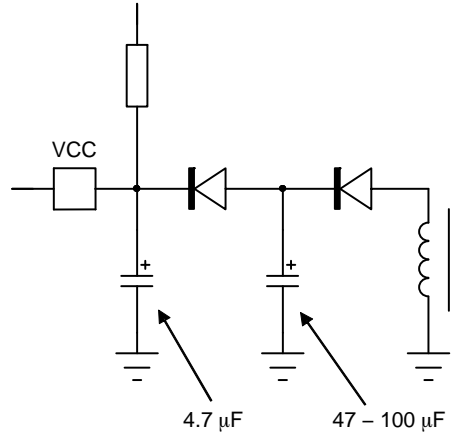

**Figure 62. Split VCC Supply**



**Figure 63. Step Dimming Chronograms**



**V<sub>CC</sub> Over Voltage Protection (Open LED Protection)**

If no output load is connected to the LED power supply, the controller must be able to safely limit the output voltage excursion.

In the NCL30083, when the V<sub>CC</sub> voltage reaches the V<sub>CC(OVP)</sub> threshold, the controller stops the DRV pulses and the 4-s timer starts counting. The IC re-start pulsing after the 4-s timer has elapsed and when V<sub>CC</sub> ≥ V<sub>CC(on)</sub>.

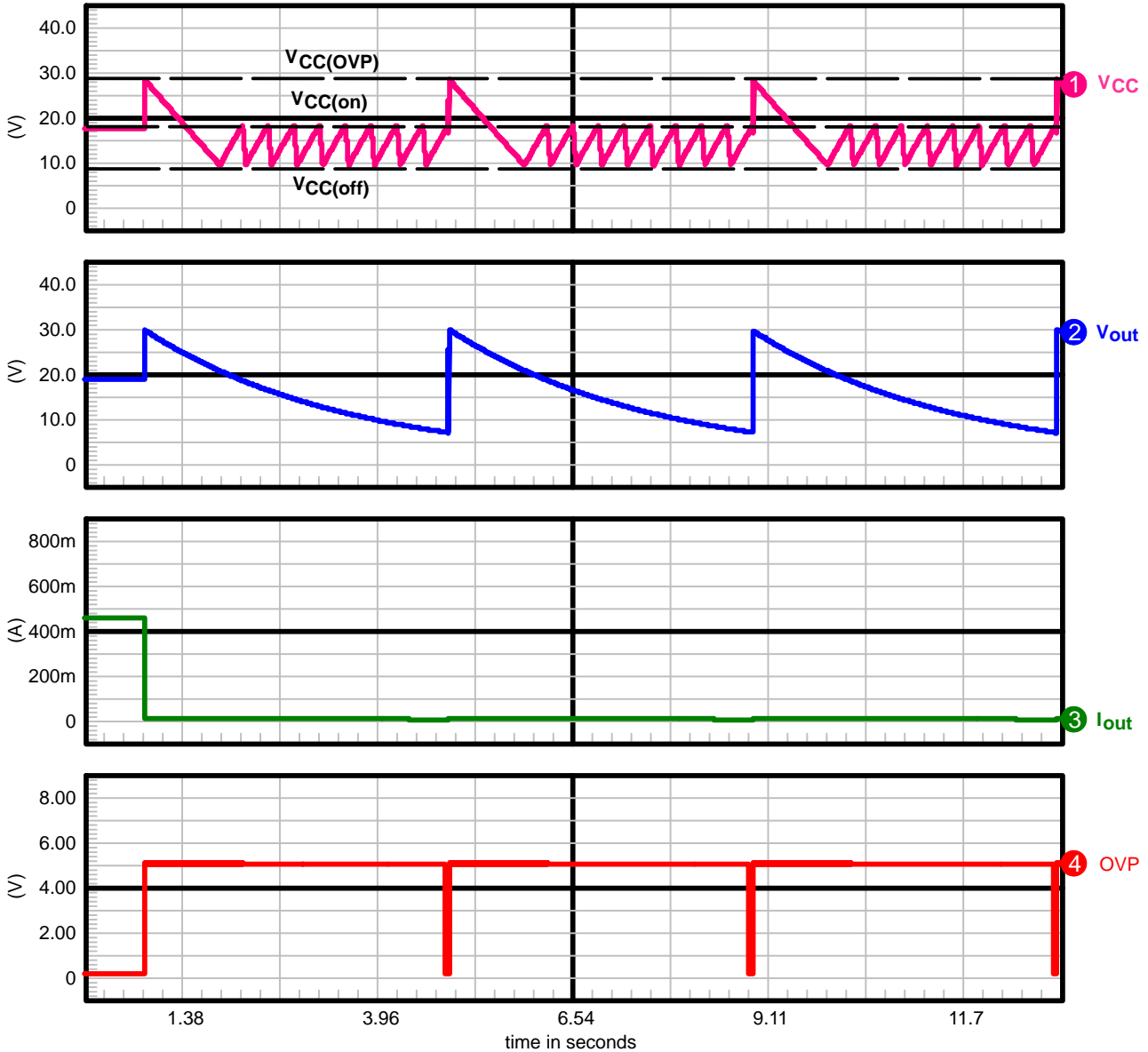

Figure 64. Open LED Protection Chronograms

**Valley Lockout**

Quasi-Square wave resonant systems have a wide switching frequency excursion. The switching frequency increases when the output load decreases or when the input voltage increases. The switching frequency of such systems must be limited.

The NCL30083 changes valley as the input voltage increases and as the output current set-point is varied (thermal fold-back and step dimming). This limits the switching frequency excursion. Once a valley is selected, the controller stays locked in the valley until the input

voltage or the output current set-point varies significantly. This avoids valley jumping and the inherent noise caused by this phenomenon.

The input voltage is sensed by the VIN pin. The internal logic selects the operating valley according to VIN pin voltage (line range detector in Figure 65), SD pin voltage and dimming state imposed by the Step Dimming circuit.

By default, when the output current is not dimmed, the controller operates in the first valley at low line and in the second valley at high line.

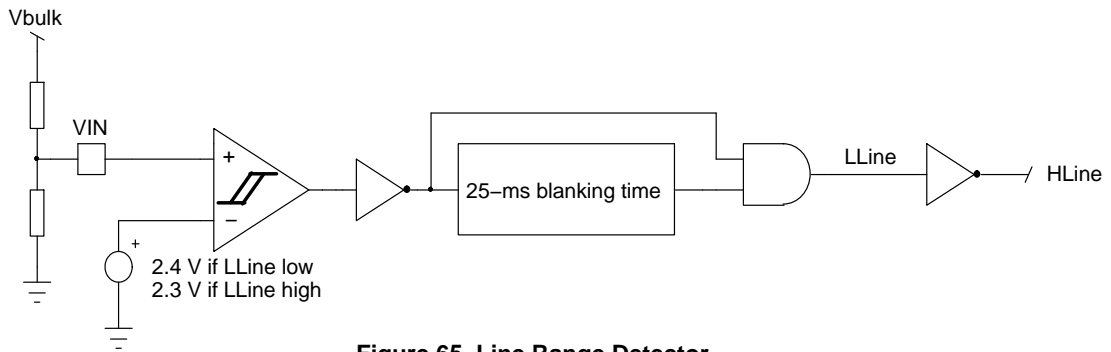

Figure 65. Line Range Detector

Table 5. VALLEY SELECTION

$I_{out}$ value at which the controller changes valley ( $I_{out}$ decreasing)	VIN pin voltage for valley change				$I_{out}$ value at which the controller changes valley ( $I_{out}$ increasing)
	0	-LL-	2.3 V	-HL-	
$I_{out}$ decreases 	100%	1 <sup>st</sup>		2 <sup>nd</sup>	100%
	75%		2 <sup>nd</sup>		78%
	50%		4 <sup>th</sup>		53%
	30%		7 <sup>th</sup>		33%
	15%		11 <sup>th</sup>		20%
	6%		13 <sup>th</sup>		8%
	0%				0%
	0	-LL-	2.4 V	-HL-	5 V
	$V_{VIN}$ increases 				
	VIN pin voltage for valley change				

**Zero Crossing Detection Block**

The ZCD pin allows detecting when the drain–source voltage of the power MOSFET reaches a valley.

A valley is detected when the voltage on pin 1 crosses below the  $V_{ZCD(THD)}$  internal threshold.

At startup or in case of extremely damped free oscillations, the ZCD comparator may not be able to detect

the valleys. To avoid such a situation, the NCL30083 features a Time–Out circuit that generates pulses if the voltage on ZCD pin stays below the  $V_{ZCD(THD)}$  threshold for 6.5  $\mu$ s.

The Time–out also acts as a substitute clock for the valley detection and simulates a missing valley in case of too damped free oscillations.

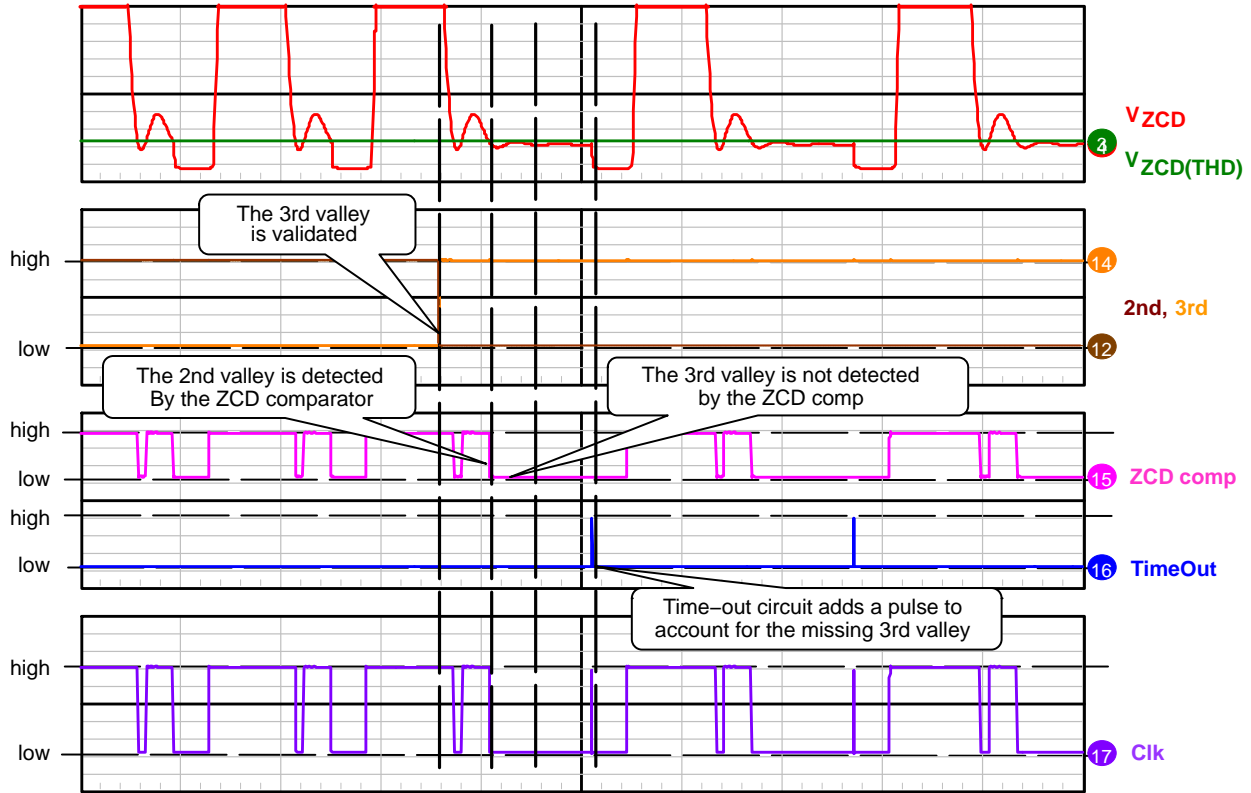

**Figure 66. Time–out Chronograms**

Because of this time–out function, if the ZCD pin or the auxiliary winding is shorted, the controller will continue switching leading to improper regulation of the LED current. Moreover during an output short circuit, the controller will strive to maintain the constant current operation.

In order to avoid these scenarios, a secondary timer starts counting when the ZCD voltage is below the  $V_{ZCD(short)}$  threshold. If this timer reaches 90 ms, the controller detects a fault and enters the auto–recovery fault mode (controller shuts–down and waits 4–s before re–starting switching).

**Line Feed–forward**

Because of the propagation delays, the MOSFET is not turned–off immediately when the current set–point is reached. As a result, the primary peak current is higher than expected and the output current increases. To compensate the peak current increase brought by the propagation delay, a positive voltage proportional to the line voltage is added on the current sense signal. The amount of offset voltage can be adjusted using the  $R_{LFF}$  resistor as shown in Figure 67.

The offset voltage is applied only during the MOSFET on–time.

This offset voltage is removed at light load during dimming when the output current drops below 15% of the programmed output current.

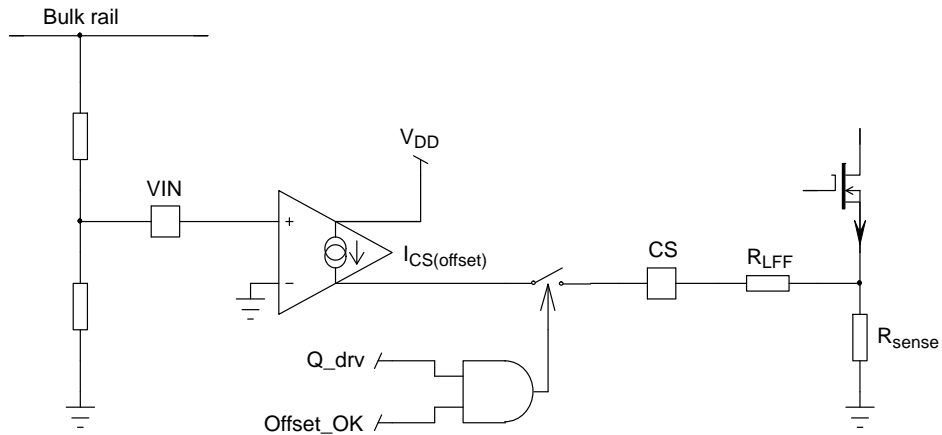

Figure 67. Line Feed-Forward Schematic

**Brown-out**

In order to protect the supply against a very low input voltage, the NCL30083 features a brown-out circuit with a fixed ON/OFF threshold. The controller is allowed to start if a voltage higher than 1 V is applied to the VIN pin and

shuts-down if the VIN pin voltage decreases and stays below 0.9 V for 50 ms nominal. Exiting a brown-out condition overrides the hiccup on V<sub>CC</sub> (V<sub>CC</sub> does not wait to reach V<sub>CC(off)</sub>) and the IC immediately goes into startup mode (I<sub>CC</sub> = I<sub>CC(start)</sub>).

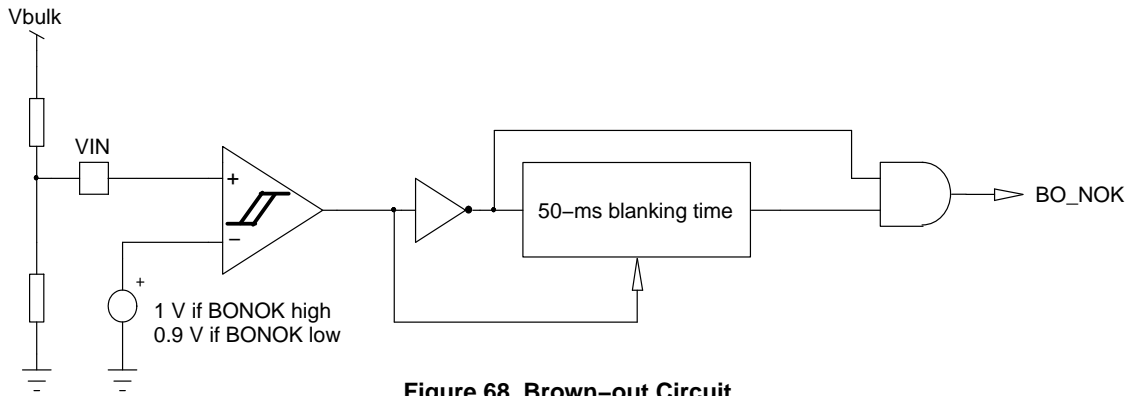

Figure 68. Brown-out Circuit

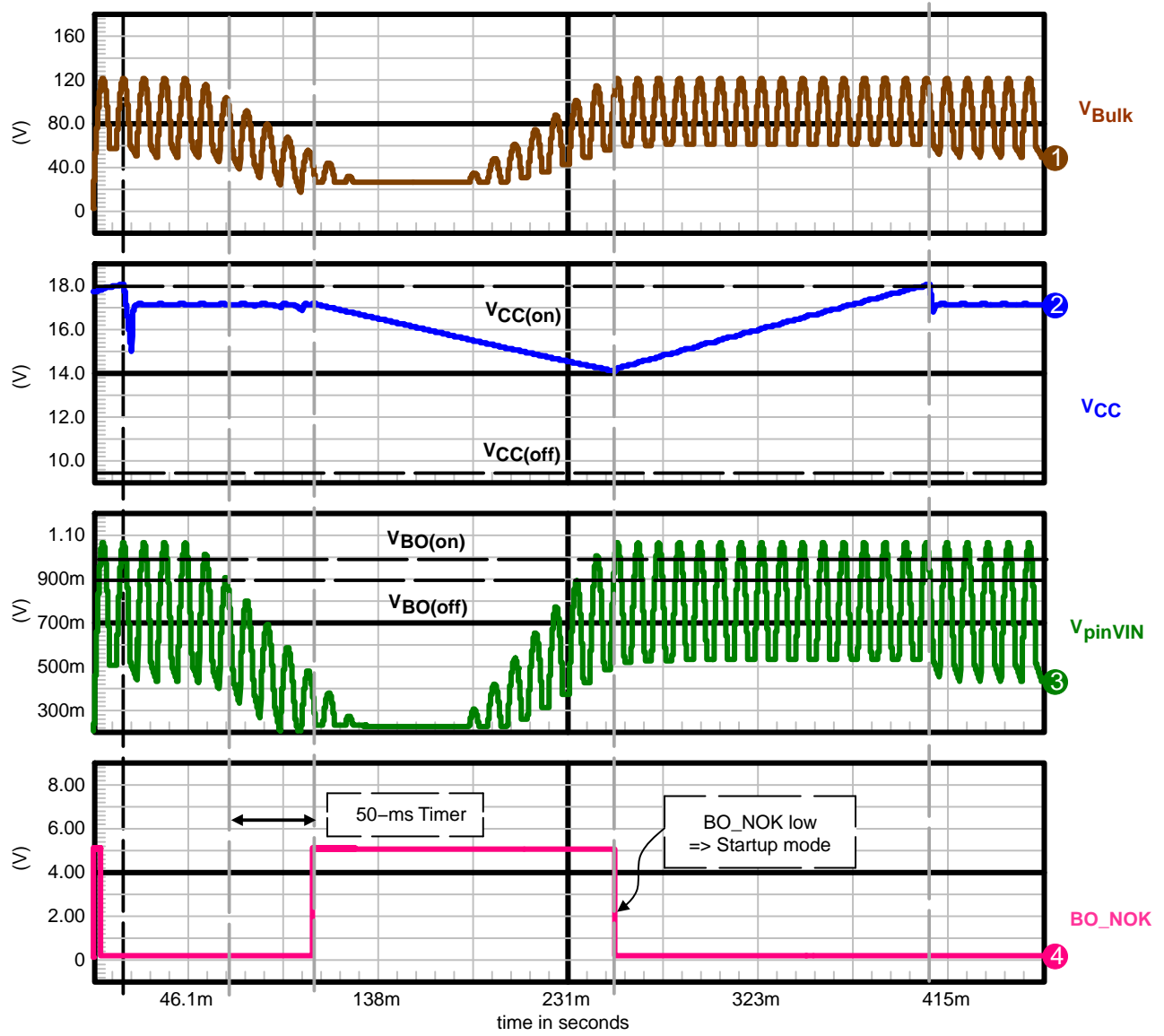
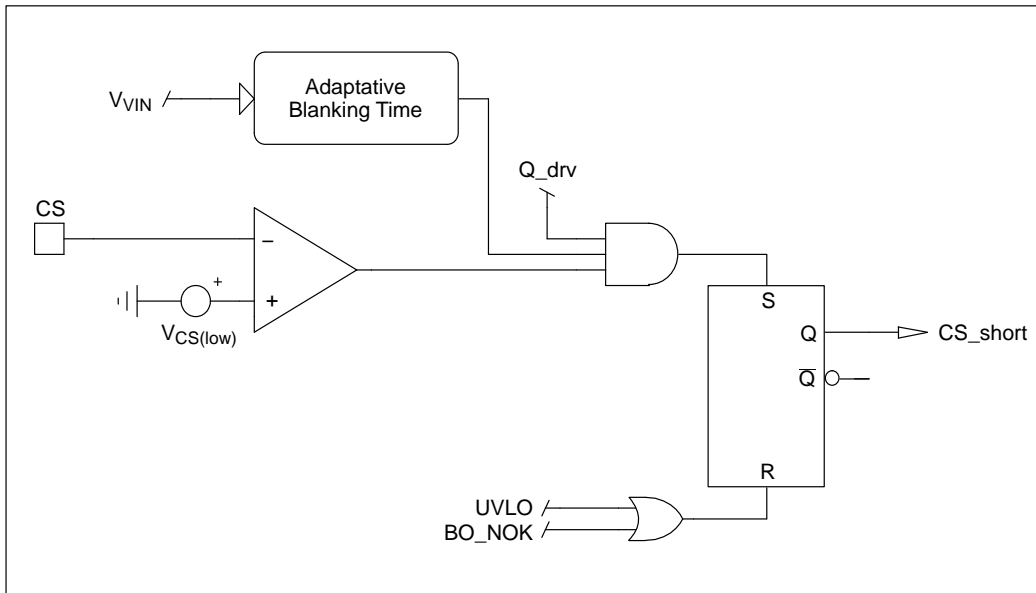

Figure 69. Brown-Out Chronograms (Valley Fill circuit is used)

**CS Pin Short Circuit Protection**

Normally, if the CS pin or the sense resistor is shorted to ground, the Driver will not be able to turn off, leading to potential damage of the power supply. To avoid this, the NCL30083 features a circuit to protect the power supply

against a short circuit of the CS pin. When the MOSFET is on, if the CS voltage stays below  $V_{CS(low)}$  after the adaptive blanking timer has elapsed, the controller shuts down and will attempt to restart on the next  $V_{CC}$  hiccup.



**Figure 70. CS Pin Short Circuit Protection Schematic**

**Fault Management**

OFF Mode

The circuit turns off whenever a major condition prevents it from operating:

- Incorrect feeding of the circuit: “UVLO high”. The UVLO signal becomes high when  $V_{CC}$  drops below  $V_{CC(off)}$  and remains high until  $V_{CC}$  exceeds  $V_{CC(on)}$ .
- OTP
- $V_{CC}$  OVP
- OVP2 (additional OVP provided by SD pin)
- Output diode short circuit protection: “WOD\_SCP high”
- Output / Auxiliary winding Short circuit protection: “Aux\_SCP high”
- Die over temperature (TSD)
- Brown-Out: “BO\_NOK” high
- Pin CS short circuited to GND: “CS\_short high”

In this mode, the DRV pulses are stopped. The  $V_{CC}$  voltage decrease through the controller own consumption ( $I_{CC1}$ ).

For the output diode short circuit protection, the CS pin short circuit protection, the output / aux. winding short circuit protection and the OVP2, the controller waits 4 seconds (auto-recovery timer) and then initiates a startup sequence ( $V_{CC} \geq V_{CC(on)}$ ) before re-starting switching.

Latch Mode

This mode is activated by the output diode short-circuit protection (WOD\_SCP), the OTP and the Aux-SCP in **version A only**.

In this mode, the DRV pulses are stopped and the controller is latched. There are hiccups on  $V_{CC}$ .

The circuit un-latches when  $V_{CC} < V_{CC(reset)}$ .

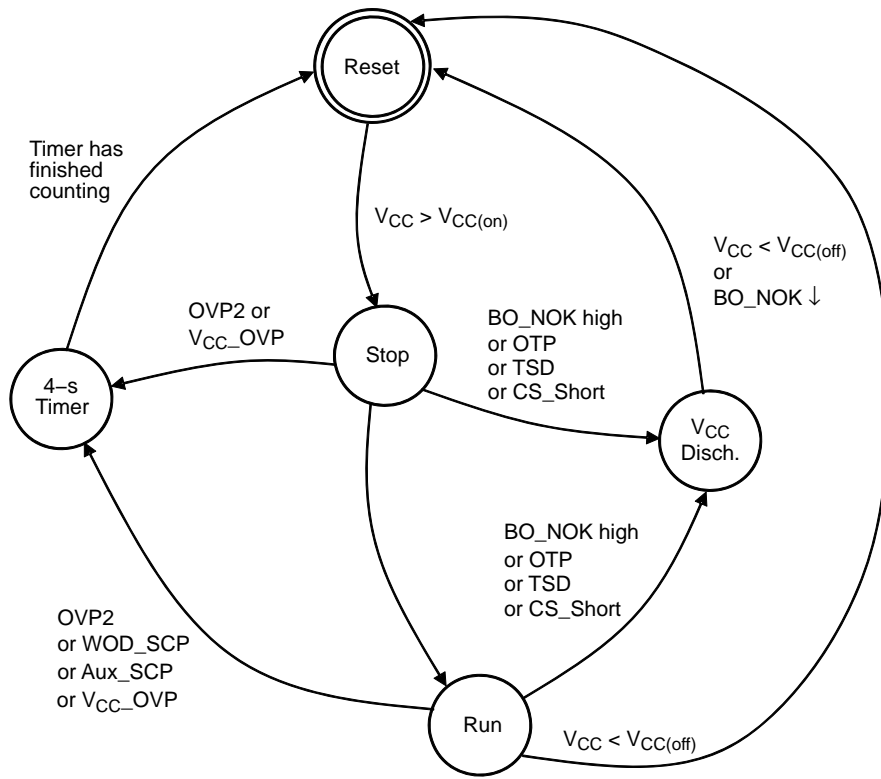

<u>With states:</u> Reset	→	Controller is reset, $I_{CC} = I_{CC(start)}$
Stop	→	Controller is ON, DRV is not switching, $t_{OTP(start)}$ has elapsed
Run	→	Normal switching
V <sub>CC</sub> Disch.	→	No switching, $I_{CC} = I_{CC1}$ , waiting for V <sub>CC</sub> to decrease to V <sub>CC(off)</sub>
4-s Timer	→	the auto-recovery timer is counting, V <sub>CC</sub> is ramping up and down between V <sub>CC(on)</sub> and V <sub>CC(off)</sub>

Figure 71. State Diagram for B Version Faults

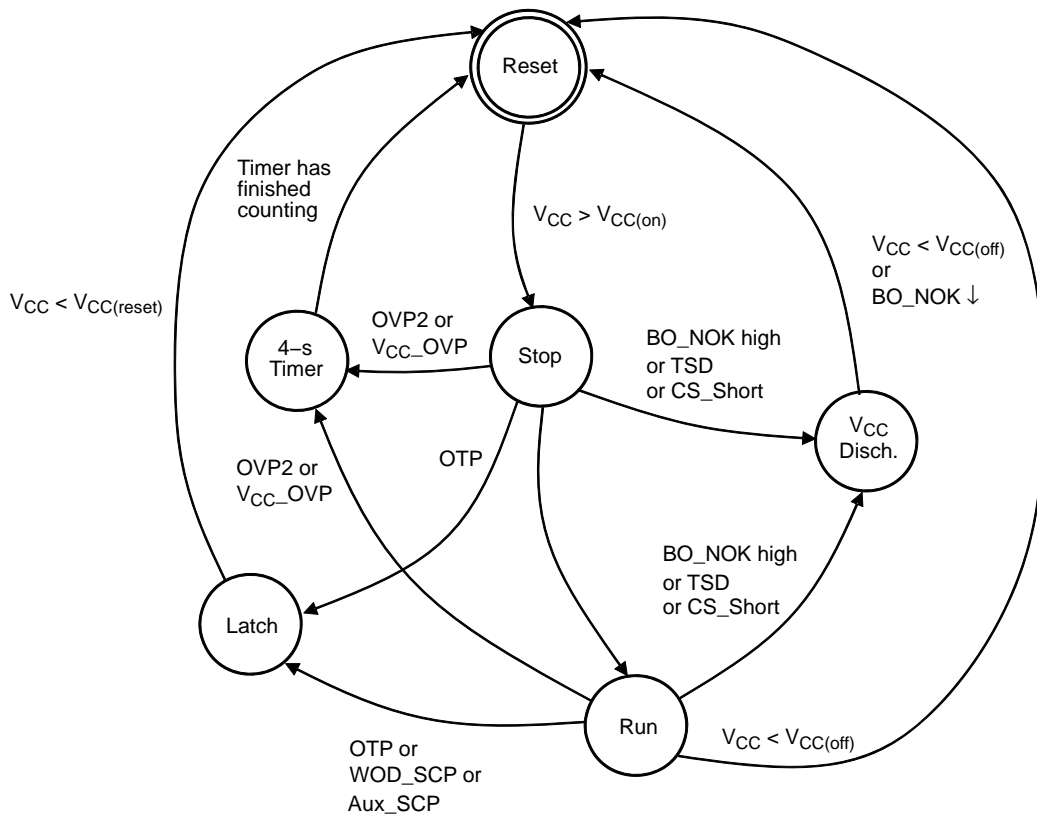

<b>With states:</b> Reset	→ Controller is reset, $I_{CC} = I_{CC(start)}$
Stop	→ Controller is ON, DRV is not switching, $t_{OTP(start)}$ has elapsed
Run	→ Normal switching
V <sub>CC</sub> Disch.	→ No switching, $I_{CC} = I_{CC1}$ , waiting for V <sub>CC</sub> to decrease to V <sub>CC(off)</sub>
4-s Timer	→ the auto-recovery timer is counting, V <sub>CC</sub> is ramping up and down between V <sub>CC(on)</sub> and V <sub>CC(off)</sub>
Latch	→ Controller is latched off, V <sub>CC</sub> is ramping up and down between V <sub>CC(on)</sub> and V <sub>CC(off)</sub> , only V <sub>CC(reset)</sub> can release the latch.

Figure 72. State Diagram for A Version Faults



# NCL30083

## OPTIONS

Controller	Output SCP	Winding/Output Diode SCP	Over Temperature Protection
NCL30083A	Latched	Latched	Latched
NCL30083B	Auto-recovery	Auto-recovery	Auto-recovery

## ORDERING INFORMATION

Device	Package Marking	Package Type	Shipping†
NCL30083ADMR2G	AAE	Micro8 (Pb-Free, Halide-Free)	4000 / Tape & Reel
NCL30083BDMR2G	AAF	Micro8 (Pb-Free, Halide-Free)	4000 / Tape & Reel
NCL30083BDR2G	L30083B	SOIC-8 (Pb-Free)	2500 / Tape & Reel

†For information on tape and reel specifications, including part orientation and tape sizes, please refer to our Tape and Reel Packaging Specifications Brochure, BRD8011/D.

# MECHANICAL CASE OUTLINE PACKAGE DIMENSIONS



SCALE 1:1

SOIC-8 NB  
CASE 751-07  
ISSUE AK

DATE 16 FEB 2011



NOTES:

1. DIMENSIONING AND TOLERANCING PER ANSI Y14.5M, 1982.
2. CONTROLLING DIMENSION: MILLIMETER.
3. DIMENSION A AND B DO NOT INCLUDE MOLD PROTRUSION.
4. MAXIMUM MOLD PROTRUSION 0.15 (0.006) PER SIDE.
5. DIMENSION D DOES NOT INCLUDE DAMBAR PROTRUSION. ALLOWABLE DAMBAR PROTRUSION SHALL BE 0.127 (0.005) TOTAL IN EXCESS OF THE D DIMENSION AT MAXIMUM MATERIAL CONDITION.
6. 751-01 THRU 751-06 ARE OBSOLETE. NEW STANDARD IS 751-07.

DIM	MILLIMETERS		INCHES	
	MIN	MAX	MIN	MAX
A	4.80	5.00	0.189	0.197
B	3.80	4.00	0.150	0.157
C	1.35	1.75	0.053	0.069
D	0.33	0.51	0.013	0.020
G	1.27 BSC		0.050 BSC	
H	0.10	0.25	0.004	0.010
J	0.19	0.25	0.007	0.010
K	0.40	1.27	0.016	0.050
M	0°	8°	0°	8°
N	0.25	0.50	0.010	0.020
S	5.80	6.20	0.228	0.244

### GENERIC MARKING DIAGRAM\*

### SOLDERING FOOTPRINT\*

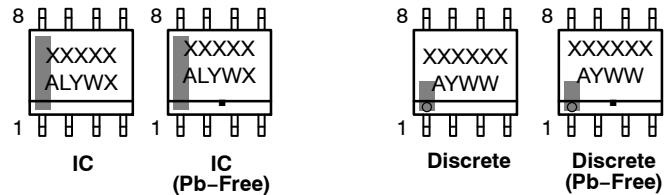
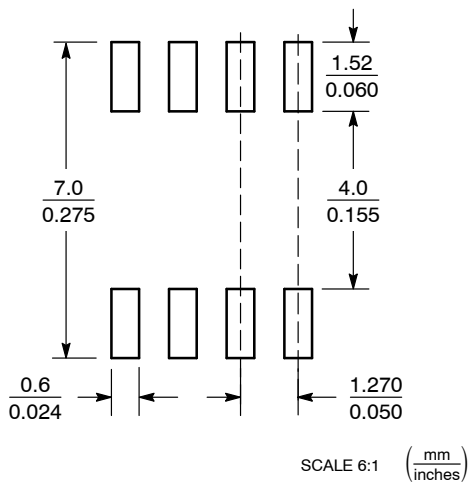

XXXXX = Specific Device Code  
A = Assembly Location  
L = Wafer Lot  
Y = Year  
W = Work Week  
▪ = Pb-Free Package

XXXXXX = Specific Device Code  
A = Assembly Location  
Y = Year  
WW = Work Week  
▪ = Pb-Free Package

\*This information is generic. Please refer to device data sheet for actual part marking. Pb-Free indicator, "G" or microdot "▪", may or may not be present. Some products may not follow the Generic Marking.

\*For additional information on our Pb-Free strategy and soldering details, please download the ON Semiconductor Soldering and Mounting Techniques Reference Manual, SOLDERRM/D.

### STYLES ON PAGE 2

DOCUMENT NUMBER:	98ASB42564B	Electronic versions are uncontrolled except when accessed directly from the Document Repository. Printed versions are uncontrolled except when stamped "CONTROLLED COPY" in red.
DESCRIPTION:	SOIC-8 NB	PAGE 1 OF 2

onsemi and ONsemi are trademarks of Semiconductor Components Industries, LLC dba onsemi or its subsidiaries in the United States and/or other countries. onsemi reserves the right to make changes without further notice to any products herein. onsemi makes no warranty, representation or guarantee regarding the suitability of its products for any particular purpose, nor does onsemi assume any liability arising out of the application or use of any product or circuit, and specifically disclaims any and all liability, including without limitation special, consequential or incidental damages. onsemi does not convey any license under its patent rights nor the rights of others.

**SOIC-8 NB**  
**CASE 751-07**  
**ISSUE AK**

DATE 16 FEB 2011

- |   |  |  |  |
|---|--|--|--|
| <p>STYLE 1:<br/>         PIN 1. EMITTER<br/>         2. COLLECTOR<br/>         3. COLLECTOR<br/>         4. EMITTER<br/>         5. EMITTER<br/>         6. BASE<br/>         7. BASE<br/>         8. EMITTER</p>   | <p>STYLE 2:<br/>         PIN 1. COLLECTOR, DIE, #1<br/>         2. COLLECTOR, #1<br/>         3. COLLECTOR, #2<br/>         4. COLLECTOR, #2<br/>         5. BASE, #2<br/>         6. EMITTER, #2<br/>         7. BASE, #1<br/>         8. EMITTER, #1</p>               | <p>STYLE 3:<br/>         PIN 1. DRAIN, DIE #1<br/>         2. DRAIN, #1<br/>         3. DRAIN, #2<br/>         4. DRAIN, #2<br/>         5. GATE, #2<br/>         6. SOURCE, #2<br/>         7. GATE, #1<br/>         8. SOURCE, #1</p>                            | <p>STYLE 4:<br/>         PIN 1. ANODE<br/>         2. ANODE<br/>         3. ANODE<br/>         4. ANODE<br/>         5. ANODE<br/>         6. ANODE<br/>         7. ANODE<br/>         8. COMMON CATHODE</p>   |
| <p>STYLE 5:<br/>         PIN 1. DRAIN<br/>         2. DRAIN<br/>         3. DRAIN<br/>         4. DRAIN<br/>         5. GATE<br/>         6. GATE<br/>         7. SOURCE<br/>         8. SOURCE</p>   | <p>STYLE 6:<br/>         PIN 1. SOURCE<br/>         2. DRAIN<br/>         3. DRAIN<br/>         4. SOURCE<br/>         5. SOURCE<br/>         6. GATE<br/>         7. GATE<br/>         8. SOURCE</p>  | <p>STYLE 7:<br/>         PIN 1. INPUT<br/>         2. EXTERNAL BYPASS<br/>         3. THIRD STAGE SOURCE<br/>         4. GROUND<br/>         5. DRAIN<br/>         6. GATE 3<br/>         7. SECOND STAGE Vd<br/>         8. FIRST STAGE Vd</p>                    | <p>STYLE 8:<br/>         PIN 1. COLLECTOR, DIE #1<br/>         2. BASE, #1<br/>         3. BASE, #2<br/>         4. COLLECTOR, #2<br/>         5. COLLECTOR, #2<br/>         6. EMITTER, #2<br/>         7. EMITTER, #1<br/>         8. COLLECTOR, #1</p>                              |
| <p>STYLE 9:<br/>         PIN 1. EMITTER, COMMON<br/>         2. COLLECTOR, DIE #1<br/>         3. COLLECTOR, DIE #2<br/>         4. EMITTER, COMMON<br/>         5. EMITTER, COMMON<br/>         6. BASE, DIE #2<br/>         7. BASE, DIE #1<br/>         8. EMITTER, COMMON</p> | <p>STYLE 10:<br/>         PIN 1. GROUND<br/>         2. BIAS 1<br/>         3. OUTPUT<br/>         4. GROUND<br/>         5. GROUND<br/>         6. BIAS 2<br/>         7. INPUT<br/>         8. GROUND</p>  | <p>STYLE 11:<br/>         PIN 1. SOURCE 1<br/>         2. GATE 1<br/>         3. SOURCE 2<br/>         4. GATE 2<br/>         5. DRAIN 2<br/>         6. DRAIN 2<br/>         7. DRAIN 1<br/>         8. DRAIN 1</p>   | <p>STYLE 12:<br/>         PIN 1. SOURCE<br/>         2. SOURCE<br/>         3. SOURCE<br/>         4. GATE<br/>         5. DRAIN<br/>         6. DRAIN<br/>         7. DRAIN<br/>         8. DRAIN</p>   |
| <p>STYLE 13:<br/>         PIN 1. N.C.<br/>         2. SOURCE<br/>         3. SOURCE<br/>         4. GATE<br/>         5. DRAIN<br/>         6. DRAIN<br/>         7. DRAIN<br/>         8. DRAIN</p>  | <p>STYLE 14:<br/>         PIN 1. N-SOURCE<br/>         2. N-GATE<br/>         3. P-SOURCE<br/>         4. P-GATE<br/>         5. P-DRAIN<br/>         6. P-DRAIN<br/>         7. N-DRAIN<br/>         8. N-DRAIN</p>   | <p>STYLE 15:<br/>         PIN 1. ANODE 1<br/>         2. ANODE 1<br/>         3. ANODE 1<br/>         4. ANODE 1<br/>         5. CATHODE, COMMON<br/>         6. CATHODE, COMMON<br/>         7. CATHODE, COMMON<br/>         8. CATHODE, COMMON</p>               | <p>STYLE 16:<br/>         PIN 1. EMITTER, DIE #1<br/>         2. BASE, DIE #1<br/>         3. EMITTER, DIE #2<br/>         4. BASE, DIE #2<br/>         5. COLLECTOR, DIE #2<br/>         6. COLLECTOR, DIE #2<br/>         7. COLLECTOR, DIE #1<br/>         8. COLLECTOR, DIE #1</p> |
| <p>STYLE 17:<br/>         PIN 1. VCC<br/>         2. V2OUT<br/>         3. V1OUT<br/>         4. TXE<br/>         5. RXE<br/>         6. VEE<br/>         7. GND<br/>         8. ACC</p>  | <p>STYLE 18:<br/>         PIN 1. ANODE<br/>         2. ANODE<br/>         3. SOURCE<br/>         4. GATE<br/>         5. DRAIN<br/>         6. DRAIN<br/>         7. CATHODE<br/>         8. CATHODE</p>   | <p>STYLE 19:<br/>         PIN 1. SOURCE 1<br/>         2. GATE 1<br/>         3. SOURCE 2<br/>         4. GATE 2<br/>         5. DRAIN 2<br/>         6. MIRROR 2<br/>         7. DRAIN 1<br/>         8. MIRROR 1</p>   | <p>STYLE 20:<br/>         PIN 1. SOURCE (N)<br/>         2. GATE (N)<br/>         3. SOURCE (P)<br/>         4. GATE (P)<br/>         5. DRAIN<br/>         6. DRAIN<br/>         7. DRAIN<br/>         8. DRAIN</p>   |
| <p>STYLE 21:<br/>         PIN 1. CATHODE 1<br/>         2. CATHODE 2<br/>         3. CATHODE 3<br/>         4. CATHODE 4<br/>         5. CATHODE 5<br/>         6. COMMON ANODE<br/>         7. COMMON ANODE<br/>         8. CATHODE 6</p>  | <p>STYLE 22:<br/>         PIN 1. I/O LINE 1<br/>         2. COMMON CATHODE/VCC<br/>         3. COMMON CATHODE/VCC<br/>         4. I/O LINE 3<br/>         5. COMMON ANODE/GND<br/>         6. I/O LINE 4<br/>         7. I/O LINE 5<br/>         8. COMMON ANODE/GND</p> | <p>STYLE 23:<br/>         PIN 1. LINE 1 IN<br/>         2. COMMON ANODE/GND<br/>         3. COMMON ANODE/GND<br/>         4. LINE 2 IN<br/>         5. LINE 2 OUT<br/>         6. COMMON ANODE/GND<br/>         7. COMMON ANODE/GND<br/>         8. LINE 1 OUT</p> | <p>STYLE 24:<br/>         PIN 1. BASE<br/>         2. EMITTER<br/>         3. COLLECTOR/ANODE<br/>         4. COLLECTOR/ANODE<br/>         5. CATHODE<br/>         6. CATHODE<br/>         7. COLLECTOR/ANODE<br/>         8. COLLECTOR/ANODE</p>                                      |
| <p>STYLE 25:<br/>         PIN 1. VIN<br/>         2. N/C<br/>         3. REXT<br/>         4. GND<br/>         5. IOUT<br/>         6. IOUT<br/>         7. IOUT<br/>         8. IOUT</p>   | <p>STYLE 26:<br/>         PIN 1. GND<br/>         2. dv/dt<br/>         3. ENABLE<br/>         4. ILIMIT<br/>         5. SOURCE<br/>         6. SOURCE<br/>         7. SOURCE<br/>         8. VCC</p>  | <p>STYLE 27:<br/>         PIN 1. ILIMIT<br/>         2. OVLO<br/>         3. UVLO<br/>         4. INPUT+<br/>         5. SOURCE<br/>         6. SOURCE<br/>         7. SOURCE<br/>         8. DRAIN</p>  | <p>STYLE 28:<br/>         PIN 1. SW_TO_GND<br/>         2. DASIC_OFF<br/>         3. DASIC_SW_DET<br/>         4. GND<br/>         5. V_MON<br/>         6. VBULK<br/>         7. VBULK<br/>         8. VIN</p>  |
| <p>STYLE 29:<br/>         PIN 1. BASE, DIE #1<br/>         2. EMITTER, #1<br/>         3. BASE, #2<br/>         4. EMITTER, #2<br/>         5. COLLECTOR, #2<br/>         6. COLLECTOR, #2<br/>         7. COLLECTOR, #1<br/>         8. COLLECTOR, #1</p>                        | <p>STYLE 30:<br/>         PIN 1. DRAIN 1<br/>         2. DRAIN 1<br/>         3. GATE 2<br/>         4. SOURCE 2<br/>         5. SOURCE 1/DRAIN 2<br/>         6. SOURCE 1/DRAIN 2<br/>         7. SOURCE 1/DRAIN 2<br/>         8. GATE 1</p>                           |  |  |

<b>DOCUMENT NUMBER:</b>	<b>98ASB42564B</b>	Electronic versions are uncontrolled except when accessed directly from the Document Repository. Printed versions are uncontrolled except when stamped "CONTROLLED COPY" in red.
<b>DESCRIPTION:</b>	<b>SOIC-8 NB</b>	<b>PAGE 2 OF 2</b>

**onsemi** and **ONSEMI** are trademarks of Semiconductor Components Industries, LLC dba **onsemi** or its subsidiaries in the United States and/or other countries. **onsemi** reserves the right to make changes without further notice to any products herein. **onsemi** makes no warranty, representation or guarantee regarding the suitability of its products for any particular purpose, nor does **onsemi** assume any liability arising out of the application or use of any product or circuit, and specifically disclaims any and all liability, including without limitation special, consequential or incidental damages. **onsemi** does not convey any license under its patent rights nor the rights of others.

# MECHANICAL CASE OUTLINE

## PACKAGE DIMENSIONS

ON Semiconductor®



SCALE 2:1

### Micro8 CASE 846A-02 ISSUE K

DATE 16 JUL 2020



TOP VIEW

NOTE 3



SIDE VIEW



END VIEW

**NOTES:**

1. DIMENSIONING AND TOLERANCING PER ASME Y14.5M, 2009.
2. CONTROLLING DIMENSION: MILLIMETERS
3. DIMENSION *b* DOES NOT INCLUDE DAMBAR PROTRUSION. ALLOWABLE PROTRUSION SHALL BE 0.10 mm IN EXCESS OF MAXIMUM MATERIAL CONDITION.
4. DIMENSIONS *D* AND *E* DO NOT INCLUDE MOLD FLASH, PROTRUSION OR GATE BURRS. MOLD FLASH, PROTRUSIONS, OR GATE BURRS SHALL NOT EXCEED 0.15 mm PER SIDE. DIMENSION *E* DOES NOT INCLUDE INTERLEAD FLASH OR PROTRUSION. INTERLEAD FLASH OR PROTRUSION SHALL NOT EXCEED 0.25 mm PER SIDE. DIMENSIONS *D* AND *E* ARE DETERMINED AT DATUM *F*.
5. DATUMS *A* AND *B* ARE TO BE DETERMINED AT DATUM *F*.
6. *A1* IS DEFINED AS THE VERTICAL DISTANCE FROM THE SEATING PLANE TO THE LOWEST POINT ON THE PACKAGE BODY.

$\phi 0.08$  (0.003) M C B S A S

DIM	MILLIMETERS		
	MIN.	NOM.	MAX.
A	---	---	1.10
A1	0.05	0.08	0.15
<i>b</i>	0.25	0.33	0.40
<i>c</i>	0.13	0.18	0.23
<i>D</i>	2.90	3.00	3.10
<i>E</i>	2.90	3.00	3.10
<i>e</i>	0.65 BSC		
<i>H<sub>E</sub></i>	4.75	4.90	5.05
<i>L</i>	0.40	0.55	0.70

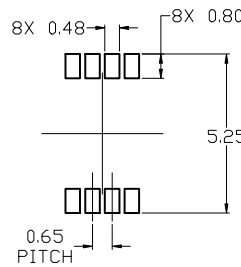

RECOMMENDED MOUNTING FOOTPRINT

For additional information on our Pb-Free strategy and soldering details, please download the ON Semiconductor Soldering and Mounting Techniques Reference Manual, SOLDERM/D.

### GENERIC MARKING DIAGRAM\*



- XXXX = Specific Device Code
- A = Assembly Location
- Y = Year
- W = Work Week
- = Pb-Free Package

(Note: Microdot may be in either location)

\*This information is generic. Please refer to device data sheet for actual part marking. Pb-Free indicator, "G" or microdot "▪", may or may not be present. Some products may not follow the Generic Marking.

**STYLE 1:**

1. SOURCE
2. SOURCE
3. SOURCE
4. GATE
5. DRAIN
6. DRAIN
7. DRAIN
8. DRAIN

**STYLE 2:**

1. SOURCE 1
2. GATE 1
3. SOURCE 2
4. GATE 2
5. DRAIN 2
6. DRAIN 2
7. DRAIN 1
8. DRAIN 1

**STYLE 3:**

1. N-SOURCE
2. N-GATE
3. P-SOURCE
4. P-GATE
5. P-DRAIN
6. P-DRAIN
7. N-DRAIN
8. N-DRAIN

<b>DOCUMENT NUMBER:</b>	<b>98ASB14087C</b>	Electronic versions are uncontrolled except when accessed directly from the Document Repository. Printed versions are uncontrolled except when stamped "CONTROLLED COPY" in red.
<b>DESCRIPTION:</b>	<b>MICRO8</b>	<b>PAGE 1 OF 1</b>

ON Semiconductor and ON are trademarks of Semiconductor Components Industries, LLC dba ON Semiconductor or its subsidiaries in the United States and/or other countries. ON Semiconductor reserves the right to make changes without further notice to any products herein. ON Semiconductor makes no warranty, representation or guarantee regarding the suitability of its products for any particular purpose, nor does ON Semiconductor assume any liability arising out of the application or use of any product or circuit, and specifically disclaims any and all liability, including without limitation special, consequential or incidental damages. ON Semiconductor does not convey any license under its patent rights nor the rights of others.

**onsemi**, **Onsemi**, and other names, marks, and brands are registered and/or common law trademarks of Semiconductor Components Industries, LLC dba "**onsemi**" or its affiliates and/or subsidiaries in the United States and/or other countries. **onsemi** owns the rights to a number of patents, trademarks, copyrights, trade secrets, and other intellectual property. A listing of **onsemi**'s product/patent coverage may be accessed at [www.onsemi.com/site/pdf/Patent-Marking.pdf](http://www.onsemi.com/site/pdf/Patent-Marking.pdf). **onsemi** reserves the right to make changes at any time to any products or information herein, without notice. The information herein is provided "as-is" and **onsemi** makes no warranty, representation or guarantee regarding the accuracy of the information, product features, availability, functionality, or suitability of its products for any particular purpose, nor does **onsemi** assume any liability arising out of the application or use of any product or circuit, and specifically disclaims any and all liability, including without limitation special, consequential or incidental damages. Buyer is responsible for its products and applications using **onsemi** products, including compliance with all laws, regulations and safety requirements or standards, regardless of any support or applications information provided by **onsemi**. "Typical" parameters which may be provided in **onsemi** data sheets and/or specifications can and do vary in different applications and actual performance may vary over time. All operating parameters, including "Typicals" must be validated for each customer application by customer's technical experts. **onsemi** does not convey any license under any of its intellectual property rights nor the rights of others. **onsemi** products are not designed, intended, or authorized for use as a critical component in life support systems or any FDA Class 3 medical devices or medical devices with a same or similar classification in a foreign jurisdiction or any devices intended for implantation in the human body. Should Buyer purchase or use **onsemi** products for any such unintended or unauthorized application, Buyer shall indemnify and hold **onsemi** and its officers, employees, subsidiaries, affiliates, and distributors harmless against all claims, costs, damages, and expenses, and reasonable attorney fees arising out of, directly or indirectly, any claim of personal injury or death associated with such unintended or unauthorized use, even if such claim alleges that **onsemi** was negligent regarding the design or manufacture of the part. **onsemi** is an Equal Opportunity/Affirmative Action Employer. This literature is subject to all applicable copyright laws and is not for resale in any manner.

## PUBLICATION ORDERING INFORMATION

### LITERATURE FULFILLMENT:

Email Requests to: [orderlit@onsemi.com](mailto:orderlit@onsemi.com)

**onsemi Website:** [www.onsemi.com](http://www.onsemi.com)

### TECHNICAL SUPPORT

**North American Technical Support:**

Voice Mail: 1 800-282-9855 Toll Free USA/Canada

Phone: 011 421 33 790 2910

**Europe, Middle East and Africa Technical Support:**

Phone: 00421 33 790 2910

For additional information, please contact your local Sales Representative