

Feed-through header - EMC 1,5/ 2-G-3,81 - 1897801

Please be informed that the data shown in this PDF Document is generated from our Online Catalog. Please find the complete data in the user's documentation. Our General Terms of Use for Downloads are valid (<http://phoenixcontact.com/download>)

PCB headers, nominal current: 8 A, number of positions: 2, pitch: 3.81 mm, color: green, contact surface: Tin, mounting: Press-in technology



The figure shows a 10-position version of the product

Your advantages

- ✓ Long-term stable press-in connection ensures high holding force without thermal load
- ✓ Maximum flexibility when it comes to device design – one header for connectors with different connection technologies

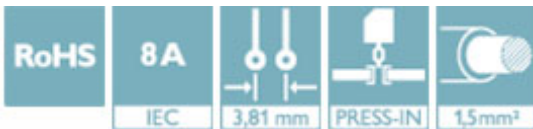

Key Commercial Data

Packing unit	50 pc
GTIN	 4 017918 166380
GTIN	4017918166380

Technical data

Dimensions

Length [l]	10.7 mm
Width	9.01 mm
Pitch	3.81 mm
Dimension a	3.81 mm
Width [w]	9.01 mm
Height [h]	10.5 mm
Height	7 mm
Length of the solder pin	3.5 mm
Pin dimensions	0.8 x 0.8 mm
Length	10.7 mm

General

Range of articles	EMC 1,5/...-G
-------------------	---------------

Feed-through header - EMC 1,5/ 2-G-3,81 - 1897801

Technical data

General

Insulating material group	IIIa
Rated surge voltage (III/3)	2.5 kV
Rated surge voltage (III/2)	2.5 kV
Rated surge voltage (II/2)	2.5 kV
Rated voltage (III/3)	160 V
Rated voltage (III/2)	160 V
Rated voltage (II/2)	250 V
Connection in acc. with standard	EN-VDE
Nominal current I_N	8 A
Maximum load current	8 A
Insulating material	PBT
Flammability rating according to UL 94	V0
Color	green
Number of positions	2

Standards and Regulations

Connection in acc. with standard	EN-VDE
	CUL
Flammability rating according to UL 94	V0

Environmental Product Compliance

China RoHS	Environmentally friendly use period: unlimited = EFUP-e
	No hazardous substances above threshold values

Drawings

Feed-through header - EMC 1,5/ 2-G-3,81 - 1897801

Drilling diagram

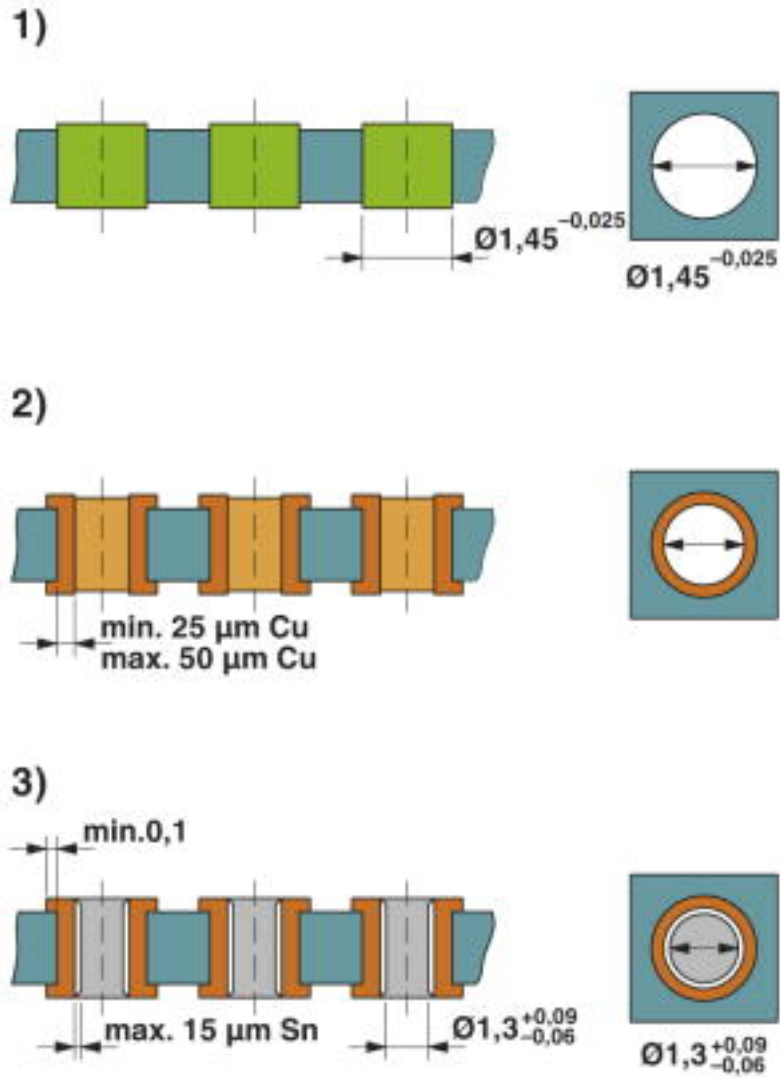

Drill hole layout in FR4 or EP-GC basic material

Feed-through header - EMC 1,5/ 2-G-3,81 - 1897801

Drilling diagram

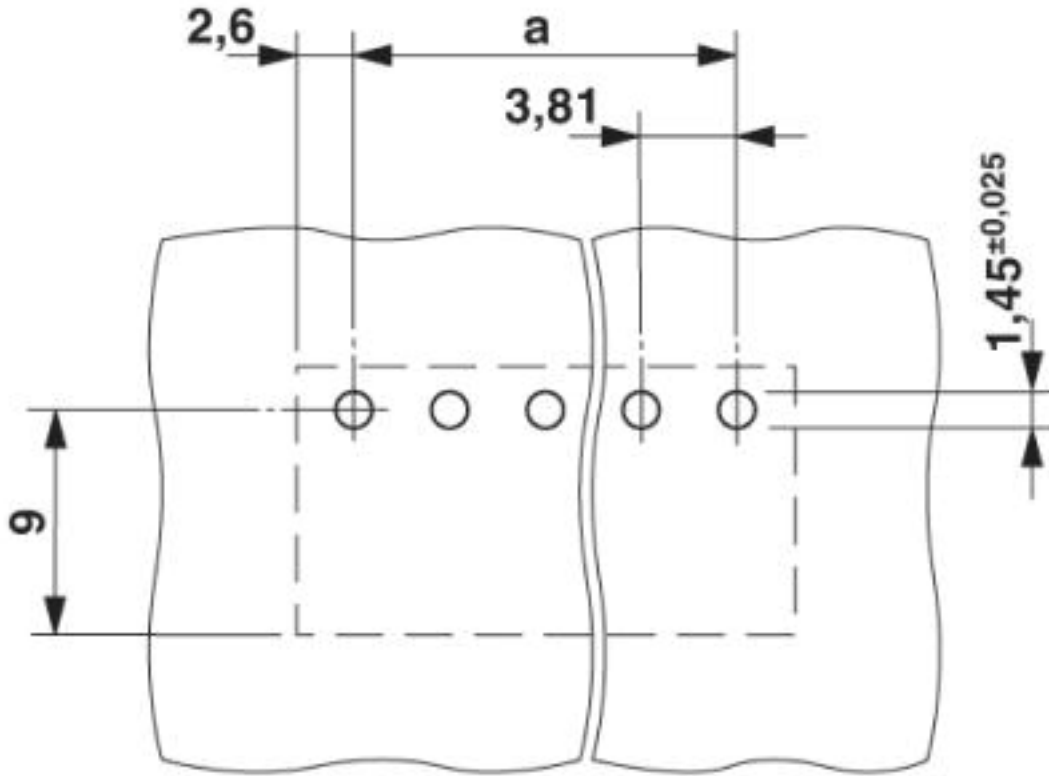

Dimensional drawing

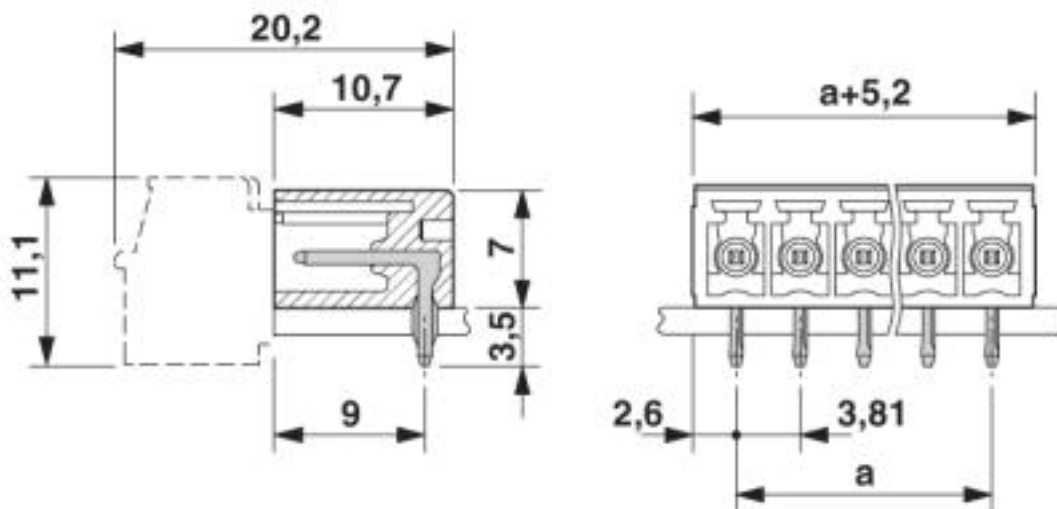

Approvals

Approvals

Feed-through header - EMC 1,5/ 2-G-3,81 - 1897801

Approvals

Approvals

EAC / cULus Recognized

Ex Approvals

Approval details

EAC		B.01742
-----	-----------------------------------------------------------------------------------	---------

cULus Recognized		http://database.ul.com/cgi-bin/XYV/template/LISEXT/1FRAME/index.htm	E60425-20110128
	B	D	
Nominal voltage UN	300 V	300 V	
Nominal current IN	8 A	8 A	

Phoenix Contact 2019 © - all rights reserved
<http://www.phoenixcontact.com>

PHOENIX CONTACT GmbH & Co. KG
Flachsmarktstr. 8
32825 Blomberg
Germany
Tel. +49 5235 300
Fax +49 5235 3 41200
<http://www.phoenixcontact.com>