

Data sheet | Item number: 231-102/026-000

1-conductor female connector; CAGE CLAMP®; 2.5 mm²; Pin spacing 5 mm;
2-pole; 2,50 mm²; gray

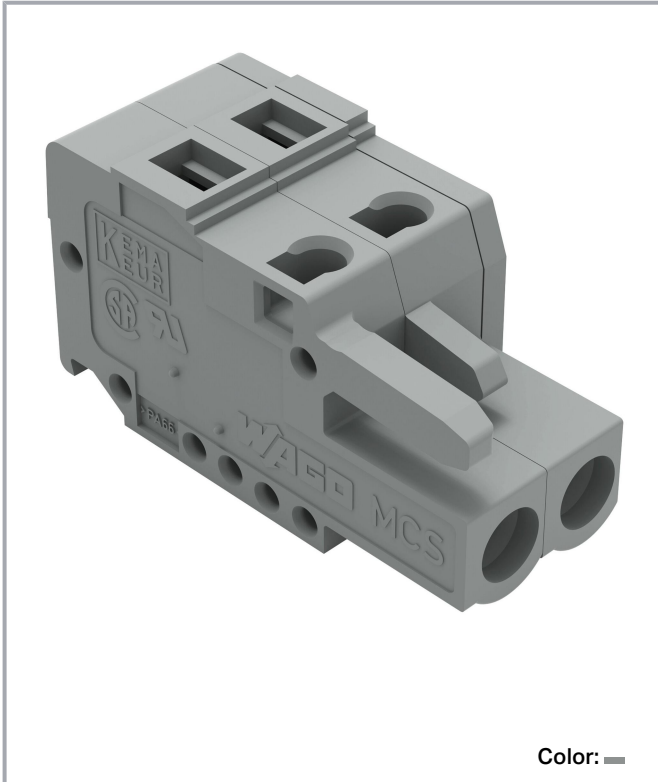

www.wago.com/231-102/026-000



Subject to changes. Please also observe the further product documentation!

WAGO GmbH & Co. KG
Hansastr. 27
32423 Minden
Phone: +49571 887-0 | Fax: +49571 887-169
Email: info.de@wago.com | Web: www.wago.com

Do you have any questions about our products?
We are always happy to take your call at +49 (571) 887-44222.

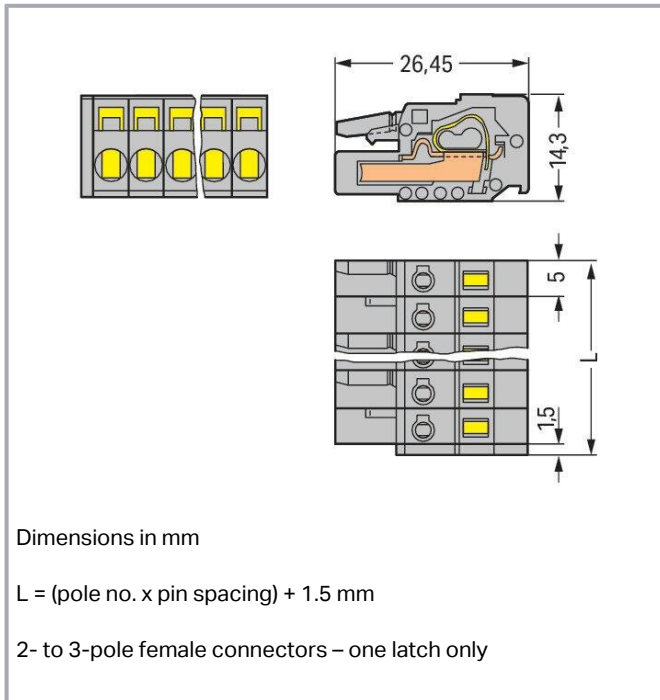

Item description

- Universal connection for all conductor types
- Easy cable pre-assembly and on-unit wiring via vertical and horizontal CAGE CLAMP® actuation
- Integrated test ports
- With coding fingers

Data

Notes

Safety information

The *MCS – MULTI CONNECTION SYSTEM* includes connectors without breaking capacity in accordance with DIN EN 61984. When used as intended, these connectors must not be connected /disconnected when live or under load. When used as intended, these connectors must not be connected/disconnected when live or under load. The circuit design should ensure header pins, which can be touched, are not live when unmated.

Variants:

Gold-plated or partially gold-plated contact surfaces
Other versions (or variants) can be requested from WAGO Sales or configured at <https://configurator.wago.com/>.

Electrical data

Subject to changes. Please also observe the further product documentation!

Ratings per IEC/EN

Ratings per	IEC/EN 60664-1
Nominal voltage (III/3)	320 V
Rated impulse voltage (III/3)	4 kV
Rated voltage (III/2)	320 V
Rated impulse voltage (III/2)	4 kV
Nominal voltage (II/2)	630 V
Rated surge voltage (II/2)	4 kV
Rated current	16 A
Legend (ratings)	(III / 2) $\hat{=}$ Overvoltage category III / Pollution degree 2

Ratings per UL 1059

Approvals per	UL 1059
Rated voltage UL (Use Group B)	300 V
Rated current UL (Use Group B)	15 A
Rated voltage UL (Use Group D)	300 V
Rated current UL (Use Group D)	10 A

Ratings per UL 1977

Rated voltage (UL 1977)	600 V
Rated current UL 1977	15 A

Ratings per CSA

Approvals per	CSA
Rated voltage CSA (Use Group B)	300 V
Rated current CSA (Use Group B)	15 A
Rated voltage CSA (Use Group D)	300 V
Rated current CSA (Use Group D)	10 A

Connection data

Connection points	2
Total number of potentials	2
Number of connection types	1
Number of levels	1

Subject to changes. Please also observe the further product documentation!



Connection 1

Connection technology	CAGE CLAMP®
Actuation type	Operating tool
Actuation direction 1	Operation parallel to conductor entry
Actuation direction 2	Operation perpendicular to conductor entry
Solid conductor	0.08 ... 2.5 mm ² / 28 ... 12 AWG
Fine-stranded conductor	0.08 ... 2.5 mm ² / 28 ... 12 AWG
Fine-stranded conductor; with insulated ferrule	0.25 ... 1.5 mm ²
Fine-stranded conductor; with uninsulated ferrule	0.25 ... 2.5 mm ²
Strip length	8 ... 9 mm / 0.31 ... 0.35 inches
Pole number	2
Conductor entry direction to mating direction	0°

Physical data

Pin spacing	5 mm / 0.197 inches
Width	11.5 mm / 0.453 inches
Height	14.3 mm / 0.563 inches
Depth	26.45 mm / 1.041 inches

Mechanical Data

Variable coding	Yes
Anti-rotation protection	Yes

Plug-in connection

Contact type (pluggable connector)	Female connector/socket
Connector (connection type)	for conductor
Mismating protection	No
Plugging without loss of pin spacing	No
Locking of plug-in connection	none

Material Data

Note (material data)	Information on material specifications can be found here
Color	gray
Material group	I

Subject to changes. Please also observe the further product documentation!

Insulation material	Polyamide (PA66)
Flammability class per UL94	V0
Clamping spring material	Chrome-nickel spring steel (CrNi)
Contact material	Copper alloy
Contact plating	Tin
Fire load	0.08 MJ
Weight	3.8 g

Environmental requirements

Limit temperature range	-60 ... +85 °C
Processing temperature	-35 ... +60 °C

Commercial data

Product Group	3 (Multi Conn. System)
eCl@ss 10.0	27-44-03-09
eCl@ss 9.0	27-44-03-09
ETIM 8.0	EC002638
ETIM 7.0	EC002638
PU (SPU)	100 pcs
Packaging type	box
Country of origin	DE
GTIN	4044918337168
Customs tariff number	85366990990

Environmental Product Compliance

RoHS Compliance Status	Compliant, No Exemption
------------------------	-------------------------

Approvals / Certificates

General approvals

Logo	Approval	Additional Approval Text	Certificate name
	CB DEKRA Certification B.V.	IEC 61984	NL-39756 /A1
	CSA DEKRA Certification B.V.	C22.2	LR 18677- 25
	KEMA/KEUR	EN 61984	71-

Subject to changes. Please also observe the further product documentation!

DEKRA Certification B.V.

121453



UL
Underwriters Laboratories Inc.

UL 1059

E45172



UR
Underwriters Laboratories Inc.

UL 1977



E45171



Declarations of conformity and manufacturer's declarations

Logo	Approval	Additional Approval Text	Certificate name
	Railway WAGO GmbH & Co. KG	-	Railway Ready

Approvals for marine applications

Logo	Approval	Additional Approval Text	Certificate name
	ABS American Bureau of Shipping	-	19- HG1869876- PDA
	BV Bureau Veritas S.A.	IEC 60998	11915/DO BV
	DNV GL Det Norske Veritas, Germanischer Lloyd	-	TAE000016Z

Counterpart



Item no.231-132/001-000

THT male header; 1.0 x 1.0 mm solder pin; straight; Pin spacing 5 mm; 2-pole; gray

www.wago.com/231-132/001-000

Subject to changes. Please also observe the further product documentation!

WAGO GmbH & Co. KG
Hansastr. 27
32423 Minden
Phone: +49571 887-0 | Fax: +49571 887-169
Email: info.de@wago.com | Web: www.wago.com

Do you have any questions about our products?
We are always happy to take your call at +49 (571) 887-44222.



Item no.231-132/040-000

THT male header; 1.0 x 1.0 mm solder pin; straight; clamping collar; Pin spacing 5 mm; 2-pole; gray

www.wago.com/231-132/040-000



Item no.231-132/001-000/105-604

THR male header; 1.0 x 1.0 mm solder pin; straight; Pin spacing 5 mm; 2-pole; black

www.wago.com/231-132/001-000/105-604



Item no.231-132/001-000/105-604/997-405

THR male header; 1.0 x 1.0 mm solder pin; straight; in tape-and-reel packaging; Pin spacing 5 mm; 2-pole; black

www.wago.com/231-132/001-000/105-604/997-405



Item no.231-162/001-000/105-604

THR male header; 1.2 x 1.2 mm solder pin; straight; Pin spacing 5 mm; 2-pole; black

www.wago.com/231-162/001-000/105-604



Item no.231-162/001-000

THT male header; 1.2 x 1.2 mm solder pin; straight; Pin spacing 5 mm; 2-pole; gray

www.wago.com/231-162/001-000



Item no.231-162/001-000/105-604/997-405

THR male header; 1.2 x 1.2 mm solder pin; straight; in tape-and-reel packaging; Pin spacing 5 mm; 2-pole; black

www.wago.com/231-162/001-000/105-604/997-405



Item no.231-162/003-000

Male connector for rail-mount terminal blocks; 1.2 x 1.2 mm pins; straight; Pin spacing 5 mm; 2-pole; gray

www.wago.com/231-162/003-000



Item no.231-432/001-000

THT male header; 1.0 x 1.0 mm solder pin; angled; Pin spacing 5 mm; 2-pole; gray

www.wago.com/231-432/001-000



Item no.231-162/040-000

THT male header; 1.2 x 1.2 mm solder pin; straight; clamping collar; Pin spacing 5 mm; 2-pole; gray

www.wago.com/231-162/040-000



Item no.231-432/040-000

THT male header; 1.0 x 1.0 mm solder pin; angled; clamping collar; Pin spacing 5 mm; 2-pole; gray

www.wago.com/231-432/040-000



Item no.231-432/001-000/105-604/997-405

THR male header; 1.0 x 1.0 mm solder pin; angled; in tape-and-reel packaging; Pin spacing 5 mm; 2-pole; black

www.wago.com/231-432/001-000/105-604/997-405

Subject to changes. Please also observe the further product documentation!

WAGO GmbH & Co. KG

Hansastr. 27

32423 Minden

Phone: +49571 887-0 | Fax: +49571 887-169

Email: info.de@wago.com | Web: www.wago.com

Do you have any questions about our products?

We are always happy to take your call at +49 (571) 887-44222.



Item no.231-432/001-000/105-604

THR male header; 1.0 x 1.0 mm solder pin; angled; Pin spacing 5 mm; 2-pole; black

www.wago.com/231-432/001-000/105-604



Item no.231-462/001-000

THT male header; 1.2 x 1.2 mm solder pin; angled; Pin spacing 5 mm; 2-pole; gray

www.wago.com/231-462/001-000



Item no.231-462/001-000/105-604

THR male header; 1.2 x 1.2 mm solder pin; angled; Pin spacing 5 mm; 2-pole; black

www.wago.com/231-462/001-000/105-604



Item no.231-462/040-000

THT male header; 1.2 x 1.2 mm solder pin; angled; clamping collar; Pin spacing 5 mm; 2-pole; gray

www.wago.com/231-462/040-000



Item no.231-462/001-000/105-604/997-405

THR male header; 1.2 x 1.2 mm solder pin; angled; in tape-and-reel packaging; Pin spacing 5 mm; 2-pole; black

www.wago.com/231-462/001-000/105-604/997-405



Item no.231-602

1-conductor male connector; CAGE CLAMP®; 2.5 mm²; Pin spacing 5 mm; 2-pole; 2,50 mm²; gray

www.wago.com/231-602



Item no.231-602/018-000

1-conductor male connector; CAGE CLAMP®; 2.5 mm²; Pin spacing 5 mm; 2-pole; DIN-35 rail /panel mounting; Snap-in mounting feet; 2,50 mm²; gray

www.wago.com/231-602/018-000



Item no.231-602/019-000

1-conductor male connector; CAGE CLAMP®; 2.5 mm²; Pin spacing 5 mm; 2-pole; clamping collar; 2,50 mm²; gray

www.wago.com/231-602/019-000

Optional accessories

Strain relief

Strain relief housing



Item no.: 232-602

Strain relief housing; for female and male connectors; 2 parts; Pin spacing 5 mm; 2-pole; gray

www.wago.com/232-602

Insulation stop

Insulation stop

Subject to changes. Please also observe the further product documentation!

WAGO GmbH & Co. KG

Hansastr. 27

32423 Minden

Phone: +49571 887-0 | Fax: +49571 887-169

Email: info.de@wago.com | Web: www.wago.com

Do you have any questions about our products?

We are always happy to take your call at +49 (571) 887-44222.



Item no.: 231-672
Insulation stop; 0.75 - 1 mm²; dark gray

www.wago.com/231-672



Item no.: 231-670
Insulation stop; 0.08-0.2 mm² / 0.2 mm² "s"; white

www.wago.com/231-670



Item no.: 231-671
Insulation stop; 0.25 - 0.5 mm²; light gray

www.wago.com/231-671

Testing and measuring

Testing accessories



Item no.: 210-136
Test plug; 2 mm Ø; with 500 mm cable; red

www.wago.com/210-136



Item no.: 231-661
Test plugs for female connectors; for 5 mm and 5.08 mm pin spacing; 2,50 mm²; light gray

www.wago.com/231-661

Ferrule

Ferrule

	Item no.: 216-101 Ferrule; Sleeve for 0.5 mm ² / AWG 22; uninsulated; electro-tin plated; silver-colored	www.wago.com/216-101
	Item no.: 216-104 Ferrule; Sleeve for 1.5 mm ² / AWG 16; uninsulated; electro-tin plated; silver-colored	www.wago.com/216-104
	Item no.: 216-106 Ferrule; Sleeve for 2.5 mm ² / AWG 14; uninsulated; electro-tin plated; silver-colored	www.wago.com/216-106
	Item no.: 216-102 Ferrule; Sleeve for 0.75 mm ² / AWG 20; uninsulated; electro-tin plated; silver-colored	www.wago.com/216-102
	Item no.: 216-103 Ferrule; Sleeve for 1 mm ² / AWG 18; uninsulated; electro-tin plated	www.wago.com/216-103
	Item no.: 216-123 Ferrule; Sleeve for 1 mm ² / AWG 18; uninsulated; electro-tin plated; silver-colored	www.wago.com/216-123
	Item no.: 216-122 Ferrule; Sleeve for 0.75 mm ² / AWG 20; uninsulated; electro-tin plated; silver-colored	www.wago.com/216-122
	Item no.: 216-124 Ferrule; Sleeve for 1.5 mm ² / AWG 16; uninsulated; electro-tin plated	www.wago.com/216-124
	Item no.: 216-142 Ferrule; Sleeve for 0.75 mm ² / 18 AWG; uninsulated; electro-tin plated; electrolytic copper; gastight crimped; acc. to DIN 46228, Part 1/08.92	www.wago.com/216-142











Subject to changes. Please also observe the further product documentation!



	Item no.: 216-132 Ferrule; Sleeve for 0.34 mm ² / AWG 24; uninsulated; electro-tin plated	www.wago.com/216-132
	Item no.: 216-121 Ferrule; Sleeve for 0.5 mm ² / AWG 22; uninsulated; electro-tin plated; silver-colored	www.wago.com/216-121
	Item no.: 216-143 Ferrule; Sleeve for 1 mm ² / AWG 18; uninsulated; electro-tin plated; electrolytic copper; gastight crimped; acc. to DIN 46228, Part 1/08.92	www.wago.com/216-143
	Item no.: 216-131 Ferrule; Sleeve for 0.25 mm ² / AWG 24; uninsulated; electro-tin plated; silver-colored	www.wago.com/216-131
	Item no.: 216-141 Ferrule; Sleeve for 0.5 mm ² / 20 AWG; uninsulated; electro-tin plated; electrolytic copper; gastight crimped; acc. to DIN 46228, Part 1/08.92	www.wago.com/216-141
	Item no.: 216-152 Ferrule; Sleeve for 0.34 mm ² / AWG 24; uninsulated; electro-tin plated	www.wago.com/216-152
	Item no.: 216-203 Ferrule; Sleeve for 1 mm ² / AWG 18; insulated; electro-tin plated; red	www.wago.com/216-203
	Item no.: 216-202 Ferrule; Sleeve for 0.75 mm ² / 18 AWG; insulated; electro-tin plated; gray	www.wago.com/216-202
	Item no.: 216-151 Ferrule; Sleeve for 0.25 mm ² / AWG 24; uninsulated; electro-tin plated	www.wago.com/216-151
	Item no.: 216-204 Ferrule; Sleeve for 1.5 mm ² / AWG 16; insulated; electro-tin plated; black	www.wago.com/216-204
	Item no.: 216-144 Ferrule; Sleeve for 1.5 mm ² / AWG 16; uninsulated; electro-tin plated; electrolytic copper; gastight crimped; acc. to DIN 46228, Part 1/08.92; silver-colored	www.wago.com/216-144
	Item no.: 216-201 Ferrule; Sleeve for 0.5 mm ² / 20 AWG; insulated; electro-tin plated; white	www.wago.com/216-201
	Item no.: 216-223 Ferrule; Sleeve for 1 mm ² / AWG 18; insulated; electro-tin plated; red	www.wago.com/216-223
	Item no.: 216-241 Ferrule; Sleeve for 0.5 mm ² / 20 AWG; insulated; electro-tin plated; electrolytic copper; gastight crimped; acc. to DIN 46228, Part 4/09.90; white	www.wago.com/216-241
	Item no.: 216-242 Ferrule; Sleeve for 0.75 mm ² / 18 AWG; insulated; electro-tin plated; electrolytic copper; gastight crimped; acc. to DIN 46228, Part 4/09.90; gray	www.wago.com/216-242
	Item no.: 216-222 Ferrule; Sleeve for 0.75 mm ² / 18 AWG; insulated; electro-tin plated; gray	www.wago.com/216-222
	Item no.: 216-221 Ferrule; Sleeve for 0.5 mm ² / 20 AWG; insulated; electro-tin plated; white	www.wago.com/216-221
	Item no.: 216-224	www.wago.com/216-224

Subject to changes. Please also observe the further product documentation!

Ferrule; Sleeve for 1.5 mm² / AWG 16; insulated; electro-tin plated; black

	Item no.: 216-243 Ferrule; Sleeve for 1 mm ² / AWG 18; insulated; electro-tin plated; electrolytic copper; gastight crimped; acc. to DIN 46228, Part 4/09.90; red	www.wago.com/216-243
	Item no.: 216-244 Ferrule; Sleeve for 1.5 mm ² / AWG 16; insulated; electro-tin plated; electrolytic copper; gastight crimped; acc. to DIN 46228, Part 4/09.90; black	www.wago.com/216-244
	Item no.: 216-263 Ferrule; Sleeve for 1 mm ² / AWG 18; insulated; electro-tin plated; electrolytic copper; gastight crimped; acc. to DIN 46228, Part 4/09.90; red	www.wago.com/216-263
	Item no.: 216-264 Ferrule; Sleeve for 1.5 mm ² / AWG 16; insulated; electro-tin plated; electrolytic copper; gastight crimped; acc. to DIN 46228, Part 4/09.90; black	www.wago.com/216-264
	Item no.: 216-284 Ferrule; Sleeve for 1.5 mm ² / AWG 16; insulated; electro-tin plated; electrolytic copper; gastight crimped; acc. to DIN 46228, Part 4/09.90; black	www.wago.com/216-284
	Item no.: 216-262 Ferrule; Sleeve for 0.75 mm ² / 18 AWG; insulated; electro-tin plated; electrolytic copper; gastight crimped; acc. to DIN 46228, Part 4/09.90; gray	www.wago.com/216-262
	Item no.: 216-301 Ferrule; Sleeve for 0.25 mm ² / AWG 24; insulated; electro-tin plated; yellow	www.wago.com/216-301
	Item no.: 216-321 Ferrule; Sleeve for 0.25 mm ² / AWG 24; insulated; electro-tin plated; yellow	www.wago.com/216-321
	Item no.: 216-322 Ferrule; Sleeve for 0.34 mm ² / 22 AWG; insulated; electro-tin plated; light turquoise	www.wago.com/216-322
	Item no.: 216-302 Ferrule; Sleeve for 0.34 mm ² / 22 AWG; insulated; electro-tin plated; light turquoise	www.wago.com/216-302















Marking accessories

Marking strip

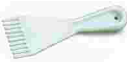
	Item no.: 210-331/500-103 Marking strips; as a DIN A4 sheet; MARKED; 1-12 (300x); Height of marker strip: 2.3 mm/0.091 in; Strip length 182 mm; Horizontal marking; Self-adhesive; white	www.wago.com/210-331/500-103
	Item no.: 210-331/500-104 Marking strips; as a DIN A4 sheet; MARKED; 13-24 (300x); Height of marker strip: 2.3 mm/0.091 in; Strip length 182 mm; Horizontal marking; Self-adhesive; white	www.wago.com/210-331/500-104
	Item no.: 210-332/500-202 Marking strips; as a DIN A4 sheet; MARKED; 1-16 (160x); Height of marker strip: 3 mm; Strip length 182 mm; Horizontal marking; Self-adhesive; white	www.wago.com/210-332/500-202
	Item no.: 210-332/500-206 Marking strips; as a DIN A4 sheet; MARKED; 33-48 (160x); Height of marker strip: 3 mm; Strip length 182 mm; Horizontal marking; Self-adhesive; white	www.wago.com/210-332/500-206

Item no.: 210-332/500-205

Subject to changes. Please also observe the further product documentation!

	Marking strips; as a DIN A4 sheet; MARKED; 1-32 (80x); Height of marker strip: 3 mm; Strip length 182 mm; Horizontal marking; Self-adhesive; white	www.wago.com/210-332/500-205
	Item no.: 210-332/500-204 Marking strips; as a DIN A4 sheet; MARKED; 17-32 (160x); Height of marker strip: 3 mm; Strip length 182 mm; Horizontal marking; Self-adhesive; white	www.wago.com/210-332/500-204
Tool		
Operating tool		
	Item no.: 209-130 Operating tool; made of insulating material; 1-way; for 264 Series (1-/2-way), 280, 281 Series (up to 3-way); natural	www.wago.com/209-130
	Item no.: 209-132 Operating tool; for connecting comb-style jumper bar; made of insulating material; 2-way; natural	www.wago.com/209-132
	Item no.: 231-159 Operating tool; natural	www.wago.com/231-159
	Item no.: 231-231 Combination operating tool; red	www.wago.com/231-231
	Item no.: 231-131 Operating tool; made of insulating material; 1-way; loose; white	www.wago.com/231-131
	Item no.: 231-291 Operating tool; made of insulating material; 1-way; loose; red	www.wago.com/231-291
	Item no.: 280-432 Operating tool; made of insulating material; 2-way; white	www.wago.com/280-432
	Item no.: 280-434 Operating tool; made of insulating material; 4-way	www.wago.com/280-434
	Item no.: 280-437 Operating tool; made of insulating material; 7-way	www.wago.com/280-437
	Item no.: 280-440 Operating tool; made of insulating material; 10-way	www.wago.com/280-440
	Item no.: 280-435 Operating tool; made of insulating material; 5-way; gray	www.wago.com/280-435
	Item no.: 280-436 Operating tool; made of insulating material; 6-way	www.wago.com/280-436
	Item no.: 280-438 Operating tool; made of insulating material; 8-way	www.wago.com/280-438

Subject to changes. Please also observe the further product documentation!



Item no.: 280-433
Operating tool; made of insulating material; 3-way

www.wago.com/280-433

Jumpers

Jumper



Item no.: 231-905
Jumper; for conductor entry; 5-way; insulated; gray

www.wago.com/231-905



Item no.: 231-903
Jumper; for conductor entry; 3-way; insulated; gray

www.wago.com/231-903



Item no.: 231-907
Jumper; for conductor entry; 7-way; insulated; gray

www.wago.com/231-907

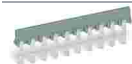

Item no.: 231-910
Jumper; for conductor entry; 10-way; insulated; gray

www.wago.com/231-910



Item no.: 231-902
Jumper; for conductor entry; 2-way; insulated; gray

www.wago.com/231-902

Cover

Cover



Item no.: 231-668
Lockout caps; for covering unused clamping units; gray

www.wago.com/231-668

Downloads

Documentation

Additional Information

Technical Section	2019 Apr 3	pdf	Download
Technical explanations		2.0 MB	

CAD/CAE-Data

CAD data

2D/3D Models 231-102/026-000	URL	Download
------------------------------	-----	----------

CAE data

EPLAN Data Portal 231-102/026-000	URL	Download
-----------------------------------	-----	----------

EPLAN Data Portal 231-102/026-000	URL	Download
-----------------------------------	-----	----------

ZUKEN Portal 231-102/026-000	URL	Download
------------------------------	-----	----------

Subject to changes. Please also observe the further product documentation!

WAGO GmbH & Co. KG
Hansastr. 27
32423 Minden
Phone: +49571 887-0 | Fax: +49571 887-169
Email: info.de@wago.com | Web: www.wago.com

Do you have any questions about our products?
We are always happy to take your call at +49 (571) 887-44222.

Environmental Product Compliance

Compliance Search

Environmental Product Compliance 231-102/026-000

URL

Download

1-conductor female connector; CAGE CLAMP®; 2.5 mm²; Pin spacing 5 mm; 2-pole;
2,50 mm²; gray

Installation Notes

Conductor termination

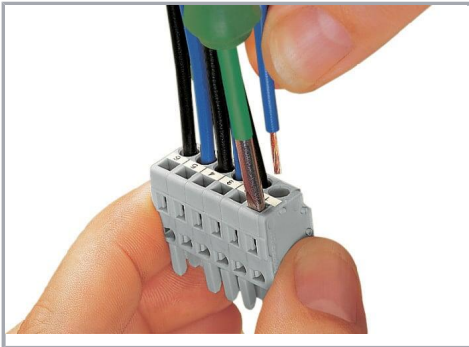

Inserting a conductor via 3.5 mm screwdriver – CAGE CLAMP® actuation parallel to conductor entry.

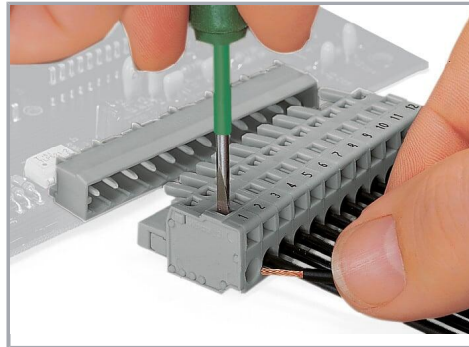

Inserting a conductor via 3.5 mm screwdriver – CAGE CLAMP® actuation perpendicular to conductor entry.

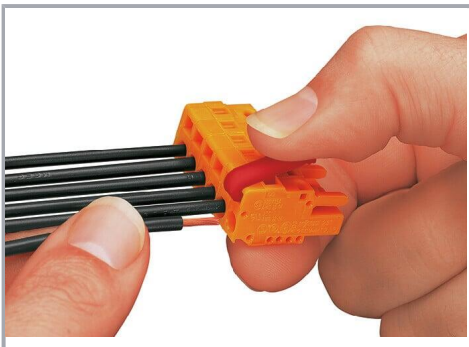

Inserting a conductor into CAGE CLAMP® unit via operating tool (231-291).



Inserting a conductor via operating tool.

Coding

Subject to changes. Please also observe the further product documentation!



Coding a female connector by removing coding finger(s).

Testing

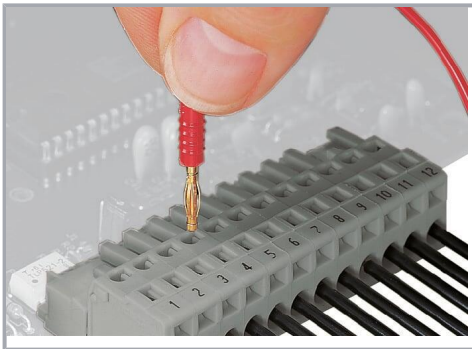

Testing – female connector with CAGE CLAMP®

Integrated test ports for testing perpendicular to conductor entry via 2 or 2.3 mm Ø test plug

Installation

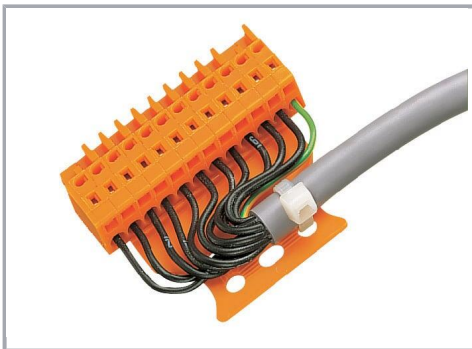

Male connector with strain relief plate

Subject to changes. Please also observe the further product documentation!

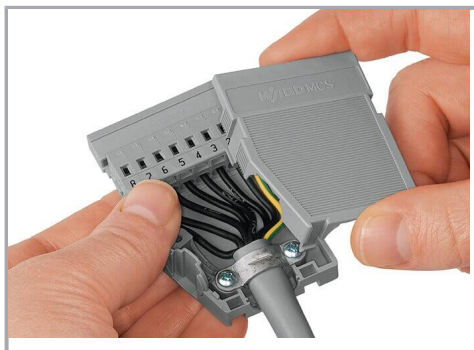

Strain relief housing shown with a male connector equipped with CAGE CLAMP®

Marking

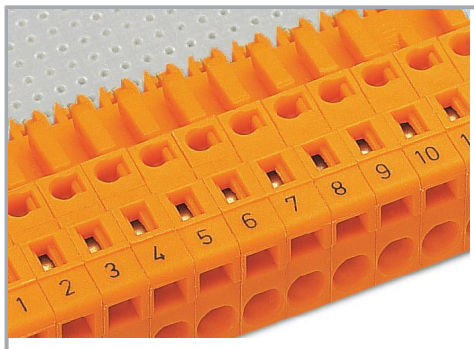

Labeling via direct marking or self-adhesive strips.

Product family

MCS MIDI Classic

[Show all products from the family](#)

Subject to changes. Please also observe the further product documentation!