

SN74HCT14-Q1 HEX SCHMITT-TRIGGER INVERTER

SCLS588A – JULY 2004 – REVISED APRIL 2008

- Qualified for Automotive Applications
- Operating Voltage Range of 4.5 V to 5.5 V
- Outputs Can Drive Up To 10 LSTTL Loads
- Low Power Consumption, 20- μ A Max I_{CC}
- \pm 4-mA Output Drive at 5 V
- Low Input Current of 1 μ A Max
- Inputs Are TTL-Voltage Compatible

D OR PW PACKAGE
(TOP VIEW)

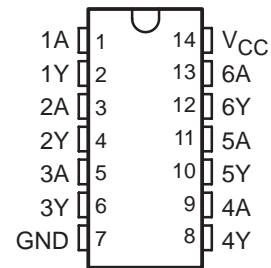

description/ordering information

The SN74HCT14 device contains six independent inverters. The device performs the Boolean function $Y = \bar{A}$ in positive logic.

ORDERING INFORMATION†

| TA | PACKAGE‡ | | ORDERABLE PART NUMBER | TOP-SIDE MARKING |
|----------------|------------|--------------|-----------------------|------------------|
| -40°C to 125°C | SOIC – D | Reel of 2500 | SN74HCT14QDRQ1 | HCT14Q |
| | TSSOP – PW | Reel of 2000 | SN74HCT14QPWRQ1 | HCT14Q |

† For the most current package and ordering information, see the Package Option Addendum at the end of this document, or see the TI web site at <http://www.ti.com>.

‡ Package drawings, thermal data, and symbolization are available at <http://www.ti.com/packaging>.

FUNCTION TABLE
(each inverter)

| INPUT A | OUTPUT Y |
|------------|-------------|
| H | L |
| L | H |

logic diagram (positive logic)



Please be aware that an important notice concerning availability, standard warranty, and use in critical applications of Texas Instruments semiconductor products and disclaimers thereto appears at the end of this data sheet.

PRODUCTION DATA information is current as of publication date. Products conform to specifications per the terms of Texas Instruments standard warranty. Production processing does not necessarily include testing of all parameters.

 **TEXAS
INSTRUMENTS**

POST OFFICE BOX 655303 • DALLAS, TEXAS 75265

Copyright © 2008, Texas Instruments Incorporated

SN74HCT14-Q1

HEX SCHMITT-TRIGGER INVERTER

SCLS588A – JULY 2004 – REVISED APRIL 2008

absolute maximum ratings over operating free-air temperature range (unless otherwise noted)†

| | |
|--|----------------------------|
| Supply voltage range, V_{CC} | -0.5 V to 7 V |
| Input voltage range, V_I (see Note 1) | -0.5 V to $V_{CC} + 0.5$ V |
| Output voltage range, V_O (see Note 1) | -0.5 V to $V_{CC} + 0.5$ V |
| Input clamp current, I_{IK} ($V_I < 0$ or $V_I > V_{CC}$) | ± 20 mA |
| Output clamp current, I_{OK} ($V_O < 0$ or $V_O > V_{CC}$) | ± 20 mA |
| Continuous output current, I_O ($V_O = 0$ to V_{CC}) | ± 25 mA |
| Continuous current through V_{CC} or GND | ± 50 mA |
| Package thermal impedance, θ_{JA} (see Note 2): D package | 86°C/W |
| PW package | 113°C/W |
| Storage temperature range, T_{stg} | -65°C to 150°C |

† Stresses beyond those listed under “absolute maximum ratings” may cause permanent damage to the device. These are stress ratings only, and functional operation of the device at these or any other conditions beyond those indicated under “recommended operating conditions” is not implied. Exposure to absolute-maximum-rated conditions for extended periods may affect device reliability.

- NOTES: 1. The input and output voltage ratings may be exceeded if the input and output current ratings are observed.
 2. The package thermal impedance is calculated in accordance with JESD 51-7.

recommended operating conditions (see Note 3)

| | MIN | MAX | UNIT |
|--------------------------------------|-----|----------|------|
| V_{CC} Supply voltage | 4.5 | 5.5 | V |
| V_I Input voltage | 0 | V_{CC} | V |
| V_O Output voltage | 0 | V_{CC} | V |
| T_A Operating free-air temperature | -40 | 125 | °C |

NOTE 3: All unused inputs of the device must be held at V_{CC} or GND to ensure proper device operation. Refer to the TI application report, *Implications of Slow or Floating CMOS Inputs*, literature number SCBA004.

electrical characteristics over recommended operating free-air temperature range (unless otherwise noted)

| PARAMETER | TEST CONDITIONS | V_{CC} | $T_A = 25^\circ\text{C}$ | | | MIN | MAX | UNIT |
|---|--|----------|--------------------------|-------|------|-----------|---------|---------------|
| | | | MIN | TYP | MAX | | | |
| V_{T+} Positive-going threshold | | 4.5 V | 1.2 | 1.5 | 1.9 | 1.2 | 1.9 | V |
| | | 5.5 V | 1.4 | 1.7 | 2.1 | 1.4 | 2.1 | |
| V_{T-} Negative-going threshold | | 4.5 V | 0.5 | 0.9 | 1.2 | 0.5 | 1.2 | V |
| | | 5.5 V | 0.6 | 1 | 1.4 | 0.6 | 1.4 | |
| ΔV_T Hysteresis ($V_{T+} - V_{T-}$) | | 4.5 V | 0.4 | 0.6 | 1.4 | 0.4 | 1.4 | V |
| | | 5.5 V | 0.4 | 0.65 | 1.5 | 0.4 | 1.5 | |
| V_{OH} | $I_{OH} = -20 \mu\text{A}$ | 4.5 V | 4.4 | 4.49 | | 4.4 | | V |
| | $I_{OH} = -4 \text{ mA}$ | 4.5 V | 3.98 | 4.3 | | 3.7 | | |
| V_{OL} | $I_{OL} = 20 \mu\text{A}$ | 4.5 V | | 0.001 | 0.1 | | 0.1 | V |
| | $I_{OL} = 4 \text{ mA}$ | 4.5 V | | 0.17 | 0.26 | | 0.4 | |
| I_I | $V_I = V_{CC}$ or GND | 5.5 V | | | | ± 0.1 | ± 1 | μA |
| I_{CC} | $V_I = V_{CC}$ or GND, $I_O = 0$ | 5.5 V | | | 2 | | 40 | μA |
| ΔI_{CC}^\ddagger | One input at 0.5 V or 2.4 V, Other inputs at GND or V_{CC} | 5.5 V | | 0.2 | 2.4 | | 3 | mA |
| C_i | $V_I = V_{CC}$ or GND | 5 V | | 3 | 10 | | 10 | pF |

‡ This is the increase in supply current for each input that is at one of the specified TTL voltage levels, rather than 0 V or V_{CC} .



switching characteristics over recommended operating free-air temperature range, $C_L = 50$ pF (unless otherwise noted) (see Figure 1)

| PARAMETER | FROM (INPUT) | TO (OUTPUT) | V_{CC} | $T_A = 25^\circ\text{C}$ | | | MIN | MAX | UNIT |
|-----------|--------------|-------------|----------|--------------------------|-----|-----|-----|-----|------|
| | | | | MIN | TYP | MAX | | | |
| t_{pd} | A | Y | 4.5 V | | 20 | 32 | | 48 | ns |
| | | | 5.5 V | | 18 | 30 | | 45 | |
| t_t | | Y | 4.5 V | | 7 | 15 | | 22 | ns |
| | | | 5.5 V | | 6 | 14 | | 20 | |

operating characteristics, $T_A = 25^\circ\text{C}$

| PARAMETER | TEST CONDITIONS | TYP | UNIT |
|--|-----------------|-----|------|
| C_{pd} Power dissipation capacitance | No load | 10 | pF |

PARAMETER MEASUREMENT INFORMATION

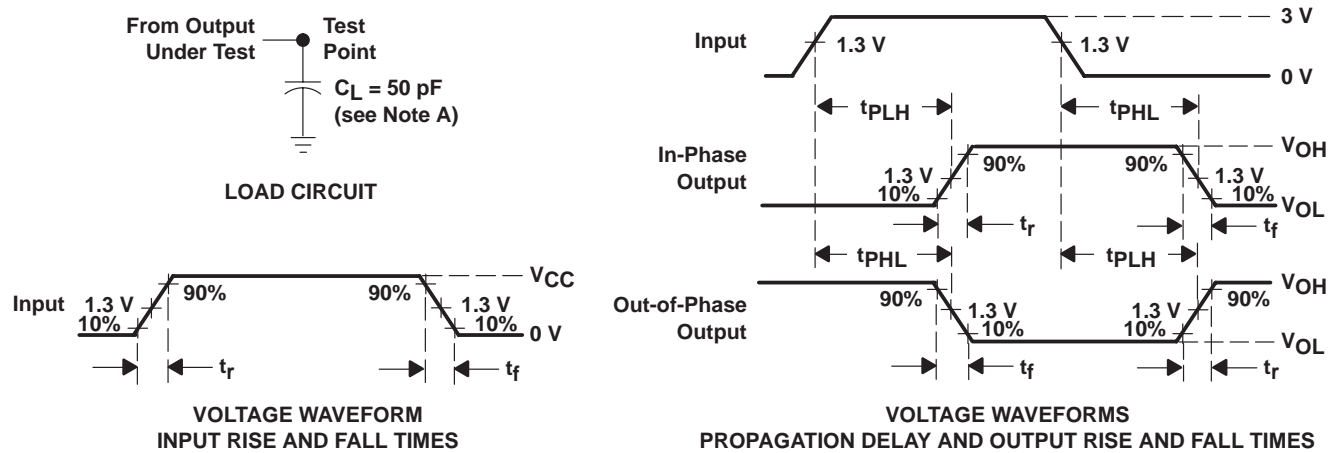

- NOTES:
- C_L includes probe and test-fixture capacitance.
 - Phase relationships between waveforms were chosen arbitrarily. All input pulses are supplied by generators having the following characteristics: $PRR \leq 1$ MHz, $Z_O = 50 \Omega$, $t_r = 6$ ns, $t_f = 6$ ns.
 - The outputs are measured one at a time, with one input transition per measurement.
 - t_{PLH} and t_{PHL} are the same as t_{pd} .

Figure 1. Load Circuit and Voltage Waveforms

SN74HCT14-Q1 HEX SCHMITT-TRIGGER INVERTER

SCLS588A – JULY 2004 – REVISED APRIL 2008

TYPICAL CHARACTERISTICS

SUPPLY CURRENT
vs
INPUT VOLTAGE

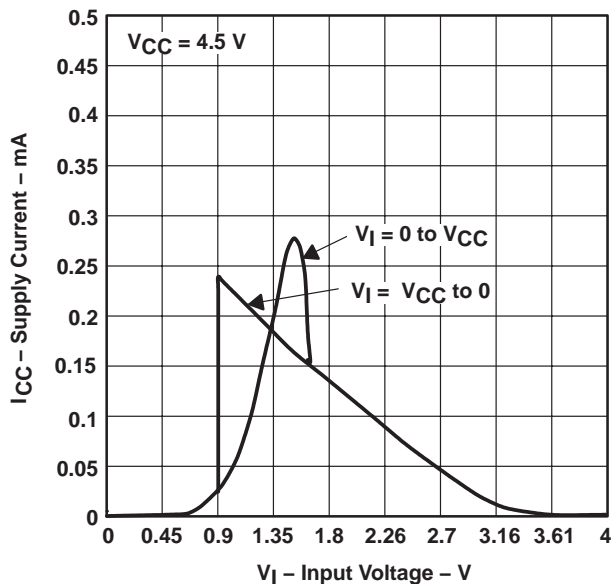

SUPPLY CURRENT
vs
INPUT VOLTAGE

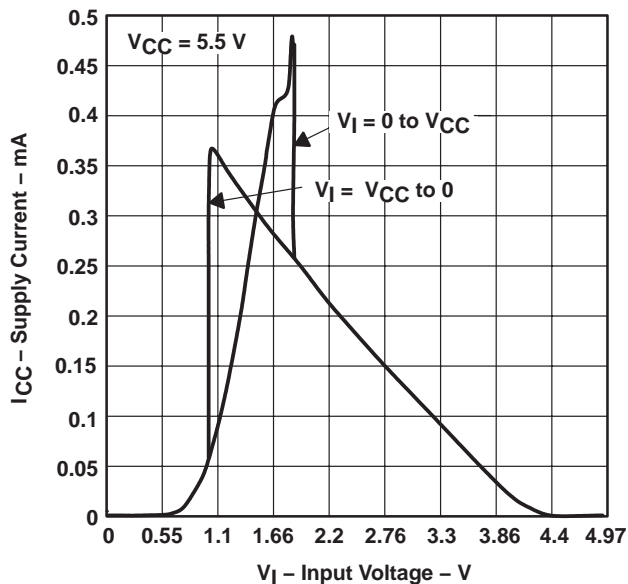

OUTPUT VOLTAGE
vs
INPUT VOLTAGE

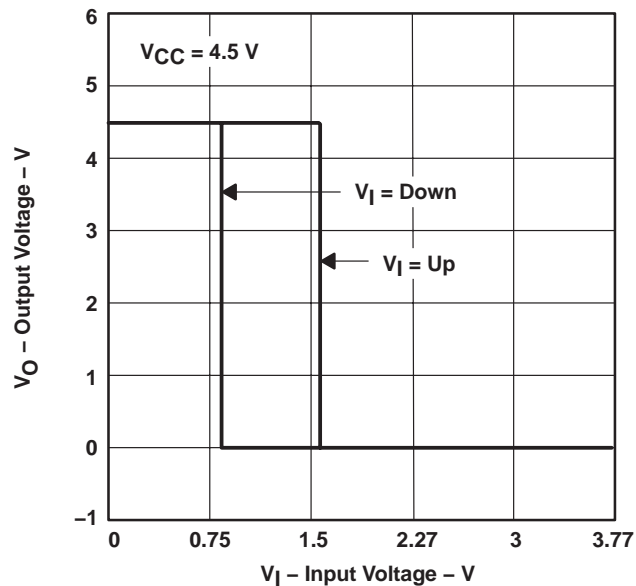

OUTPUT VOLTAGE
vs
INPUT VOLTAGE

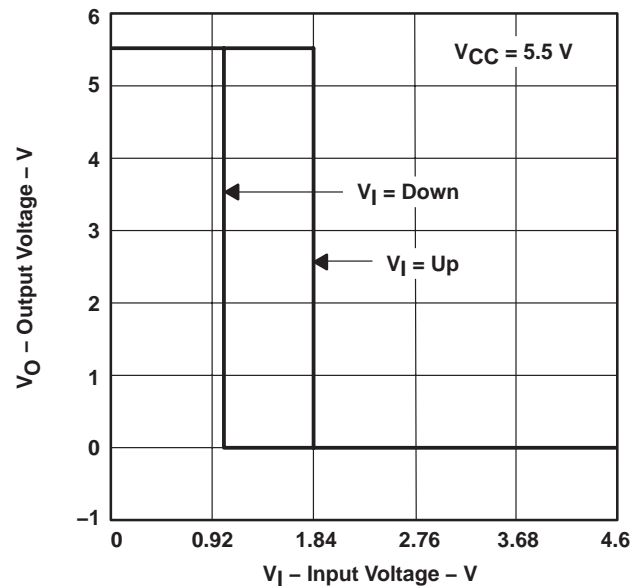

PACKAGING INFORMATION

| Orderable Device | Status (1) | Package Type | Package Drawing | Pins | Package Qty | Eco Plan (2) | Lead finish/ Ball material (6) | MSL Peak Temp (3) | Op Temp (°C) | Device Marking (4/5) | Samples |
|-------------------|---------------|--------------|-----------------|------|-------------|-----------------|--------------------------------------|----------------------|--------------|-------------------------|-------------------------|
| SN74HCT14QPWRG4Q1 | ACTIVE | TSSOP | PW | 14 | 2000 | RoHS & Green | NIPDAU | Level-1-260C-UNLIM | -40 to 125 | HCT14Q | Samples |
| SN74HCT14QPWRQ1 | ACTIVE | TSSOP | PW | 14 | 2000 | RoHS & Green | NIPDAU | Level-3-260C-168 HR | -40 to 125 | HCT14Q | Samples |

(1) The marketing status values are defined as follows:

ACTIVE: Product device recommended for new designs.

LIFEBUY: TI has announced that the device will be discontinued, and a lifetime-buy period is in effect.

NRND: Not recommended for new designs. Device is in production to support existing customers, but TI does not recommend using this part in a new design.

PREVIEW: Device has been announced but is not in production. Samples may or may not be available.

OBSOLETE: TI has discontinued the production of the device.

(2) **RoHS:** TI defines "RoHS" to mean semiconductor products that are compliant with the current EU RoHS requirements for all 10 RoHS substances, including the requirement that RoHS substance do not exceed 0.1% by weight in homogeneous materials. Where designed to be soldered at high temperatures, "RoHS" products are suitable for use in specified lead-free processes. TI may reference these types of products as "Pb-Free".

RoHS Exempt: TI defines "RoHS Exempt" to mean products that contain lead but are compliant with EU RoHS pursuant to a specific EU RoHS exemption.

Green: TI defines "Green" to mean the content of Chlorine (Cl) and Bromine (Br) based flame retardants meet JS709B low halogen requirements of <=1000ppm threshold. Antimony trioxide based flame retardants must also meet the <=1000ppm threshold requirement.

(3) MSL, Peak Temp. - The Moisture Sensitivity Level rating according to the JEDEC industry standard classifications, and peak solder temperature.

(4) There may be additional marking, which relates to the logo, the lot trace code information, or the environmental category on the device.

(5) Multiple Device Markings will be inside parentheses. Only one Device Marking contained in parentheses and separated by a "~" will appear on a device. If a line is indented then it is a continuation of the previous line and the two combined represent the entire Device Marking for that device.

(6) Lead finish/Ball material - Orderable Devices may have multiple material finish options. Finish options are separated by a vertical ruled line. Lead finish/Ball material values may wrap to two lines if the finish value exceeds the maximum column width.

Important Information and Disclaimer:The information provided on this page represents TI's knowledge and belief as of the date that it is provided. TI bases its knowledge and belief on information provided by third parties, and makes no representation or warranty as to the accuracy of such information. Efforts are underway to better integrate information from third parties. TI has taken and continues to take reasonable steps to provide representative and accurate information but may not have conducted destructive testing or chemical analysis on incoming materials and chemicals. TI and TI suppliers consider certain information to be proprietary, and thus CAS numbers and other limited information may not be available for release.

In no event shall TI's liability arising out of such information exceed the total purchase price of the TI part(s) at issue in this document sold by TI to Customer on an annual basis.

OTHER QUALIFIED VERSIONS OF SN74HCT14-Q1 :

- Catalog: [SN74HCT14](#)
- Military: [SN54HCT14](#)

NOTE: Qualified Version Definitions:

- Catalog - TI's standard catalog product
- Military - QML certified for Military and Defense Applications

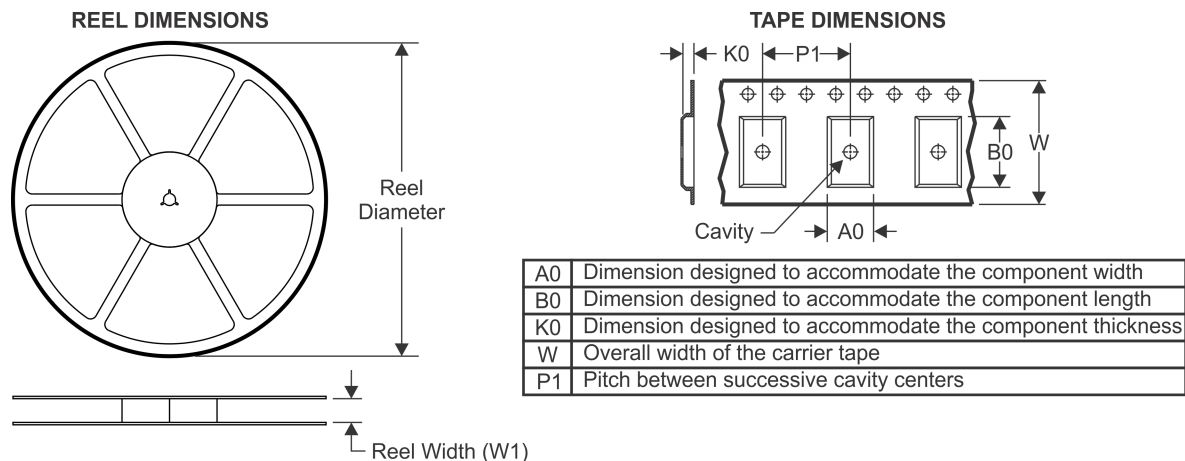
TAPE AND REEL INFORMATION

QUADRANT ASSIGNMENTS FOR PIN 1 ORIENTATION IN TAPE

*All dimensions are nominal

| Device | Package Type | Package Drawing | Pins | SPQ | Reel Diameter (mm) | Reel Width W1 (mm) | A0 (mm) | B0 (mm) | K0 (mm) | P1 (mm) | W (mm) | Pin1 Quadrant |
|-------------------|--------------|-----------------|------|------|--------------------|--------------------|---------|---------|---------|---------|--------|---------------|
| SN74HCT14QPWRG4Q1 | TSSOP | PW | 14 | 2000 | 330.0 | 12.4 | 6.9 | 5.6 | 1.6 | 8.0 | 12.0 | Q1 |
| SN74HCT14QPWRQ1 | TSSOP | PW | 14 | 2000 | 330.0 | 12.4 | 6.9 | 5.6 | 1.6 | 8.0 | 12.0 | Q1 |

TAPE AND REEL BOX DIMENSIONS

*All dimensions are nominal

| Device | Package Type | Package Drawing | Pins | SPQ | Length (mm) | Width (mm) | Height (mm) |
|-------------------|--------------|-----------------|------|------|-------------|------------|-------------|
| SN74HCT14QPWRG4Q1 | TSSOP | PW | 14 | 2000 | 853.0 | 449.0 | 35.0 |
| SN74HCT14QPWRQ1 | TSSOP | PW | 14 | 2000 | 853.0 | 449.0 | 35.0 |

PW (R-PDSO-G14)

PLASTIC SMALL OUTLINE



- NOTES:
- A. All linear dimensions are in millimeters.
 - B. This drawing is subject to change without notice.
 - C. Publication IPC-7351 is recommended for alternate designs.
 - D. Laser cutting apertures with trapezoidal walls and also rounding corners will offer better paste release. Customers should contact their board assembly site for stencil design recommendations. Refer to IPC-7525 for other stencil recommendations.
 - E. Customers should contact their board fabrication site for solder mask tolerances between and around signal pads.

IMPORTANT NOTICE AND DISCLAIMER

TI PROVIDES TECHNICAL AND RELIABILITY DATA (INCLUDING DATA SHEETS), DESIGN RESOURCES (INCLUDING REFERENCE DESIGNS), APPLICATION OR OTHER DESIGN ADVICE, WEB TOOLS, SAFETY INFORMATION, AND OTHER RESOURCES "AS IS" AND WITH ALL FAULTS, AND DISCLAIMS ALL WARRANTIES, EXPRESS AND IMPLIED, INCLUDING WITHOUT LIMITATION ANY IMPLIED WARRANTIES OF MERCHANTABILITY, FITNESS FOR A PARTICULAR PURPOSE OR NON-INFRINGEMENT OF THIRD PARTY INTELLECTUAL PROPERTY RIGHTS.

These resources are intended for skilled developers designing with TI products. You are solely responsible for (1) selecting the appropriate TI products for your application, (2) designing, validating and testing your application, and (3) ensuring your application meets applicable standards, and any other safety, security, regulatory or other requirements.

These resources are subject to change without notice. TI grants you permission to use these resources only for development of an application that uses the TI products described in the resource. Other reproduction and display of these resources is prohibited. No license is granted to any other TI intellectual property right or to any third party intellectual property right. TI disclaims responsibility for, and you will fully indemnify TI and its representatives against, any claims, damages, costs, losses, and liabilities arising out of your use of these resources.

TI's products are provided subject to [TI's Terms of Sale](#) or other applicable terms available either on ti.com or provided in conjunction with such TI products. TI's provision of these resources does not expand or otherwise alter TI's applicable warranties or warranty disclaimers for TI products.

TI objects to and rejects any additional or different terms you may have proposed.

Mailing Address: Texas Instruments, Post Office Box 655303, Dallas, Texas 75265
Copyright © 2021, Texas Instruments Incorporated