

PerFET™ Power Transistor

FEATURES

- Ultra-low On-resistance
- Wettable Flank leads for Enhanced AOI
- 100% UIS and Rg tested
- 175°C Operating Junction Temperature
- RoHS Compliant
- Halogen-Free according to IEC 61249-2-21

APPLICATIONS

- DC-DC Converters
- Solenoid and Motor Drivers
- Load Switch

PRODUCT SUMMARY			
PARAMETER	VALUE	UNIT	
V_{DS}	40	V	
$R_{DS(on)}$ (max)	$V_{GS} = 10V$	7	mΩ
	$V_{GS} = 4.5V$	9.8	
Q_g	$V_{GS} = 4.5V$	11	nC



PDFN56U

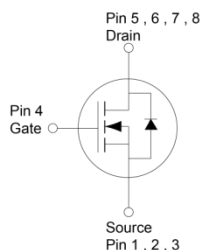
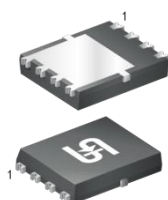

Note: MSL 1 (Moisture Sensitivity Level) per J-STD-020

ABSOLUTE MAXIMUM RATINGS ($T_A = 25^\circ\text{C}$ unless otherwise noted)				
PARAMETER		SYMBOL	LIMIT	UNIT
Drain-Source Voltage		V_{DS}	40	V
Gate-Source Voltage		V_{GS}	± 16	V
Continuous Drain Current, Silicon limited	$T_C = 25^\circ\text{C}$	I_D	68	A
Continuous Drain Current (Note 1)	$T_C = 25^\circ\text{C}$	I_D	54	A
	$T_C = 100^\circ\text{C}$		48	
	$T_A = 25^\circ\text{C}$		16	
Pulsed Drain Current		I_{DM}	216	A
Single Pulse Avalanche Current (Note 2)		I_{AS}	18.2	A
Single Pulse Avalanche Energy (Note 2)		E_{AS}	49.9	mJ
Total Power Dissipation	$T_C = 25^\circ\text{C}$	P_D	46.8	W
	$T_C = 125^\circ\text{C}$		15.6	
Operating Junction and Storage Temperature Range		T_J, T_{STG}	-55 to +175	$^\circ\text{C}$

THERMAL RESISTANCE			
PARAMETER	SYMBOL	MAXIMUM	UNIT
Thermal Resistance – Junction to Case	$R_{\theta JC}$	3.2	$^\circ\text{C/W}$
Thermal Resistance – Junction to Ambient	$R_{\theta JA}$	50	$^\circ\text{C/W}$

Note: $R_{\theta JA}$ is the sum of the junction-to-case and case-to-ambient thermal resistances. The case-thermal reference is defined at the solder mounting surface of the drain pins. $R_{\theta JC}$ is guaranteed by design while $R_{\theta CA}$ is determined by the user's board design.

ELECTRICAL CHARACTERISTICS ($T_A = 25^\circ\text{C}$ unless otherwise noted)						
PARAMETER	CONDITIONS	SYMBOL	MIN	TYP	MAX	UNIT
Static						
Drain-Source Breakdown Voltage	$V_{GS} = 0\text{V}, I_D = 1\text{mA}$	BV_{DSS}	40	--	--	V
Gate Threshold Voltage	$V_{GS} = V_{DS}, I_D = 250\mu\text{A}$	$V_{GS(TH)}$	1.4	1.8	2.2	V
Gate-Source Leakage Current	$V_{GS} = \pm 16\text{V}, V_{DS} = 0\text{V}$	I_{GSS}	--	--	± 100	nA
Drain-Source Leakage Current	$V_{GS} = 0\text{V}, V_{DS} = 40\text{V}$	I_{DSS}	--	--	1	μA
	$V_{GS} = 0\text{V}, V_{DS} = 40\text{V}$ $T_J = 125^\circ\text{C}$		--	--	100	
Drain-Source On-State Resistance (Note 3)	$V_{GS} = 10\text{V}, I_D = 27\text{A}$	$R_{DS(on)}$	--	5.6	7	m Ω
	$V_{GS} = 4.5\text{V}, I_D = 27\text{A}$		--	7.5	9.8	
Forward Transconductance (Note 3)	$V_{DS} = 10\text{V}, I_D = 7\text{A}$	g_{fs}	--	89	--	S
Dynamic						
Total Gate Charge	$V_{GS} = 4.5\text{V}, V_{DS} = 20\text{V},$ $I_D = 16\text{A}$	Q_g	--	11	--	nC
Total Gate Charge	$V_{GS} = 10\text{V}, V_{DS} = 20\text{V},$ $I_D = 16\text{A}$	Q_g	--	23	--	
Gate-Source Charge		Q_{gs}	--	4.3	--	
Gate-Drain Charge		Q_{gd}	--	3.5	--	
Input Capacitance	$V_{GS} = 0\text{V}, V_{DS} = 25\text{V},$ $f = 1.0\text{MHz}$	C_{iss}	--	1446	--	pF
Output Capacitance		C_{oss}	--	229	--	
Reverse Transfer Capacitance		C_{rss}	--	32	--	
Gate Resistance	$f = 1.0\text{MHz}$	R_g	--	1.4	--	Ω
Switching (Note 4)						
Turn-On Delay Time	$V_{GS} = 10\text{V}, V_{DS} = 20\text{V},$ $I_D = 16\text{A}, R_G = 3.3\Omega$	$t_{d(on)}$	--	7.2	--	nS
Rise Time		t_r	--	50.8	--	
Turn-Off Delay Time		$t_{d(off)}$	--	23.2	--	
Fall Time		t_f	--	5.7	--	
Source-Drain Diode						
Diode Forward Voltage (Note 3)	$V_{GS} = 0\text{V}, I_S = 27\text{A}$	V_{SD}	--	--	1.1	V
Reverse Recovery Time	$I_S = 16\text{A},$ $di/dt = 100\text{A}/\mu\text{s}$	t_{rr}	--	32	--	nS
Reverse Recovery Charge		Q_{rr}	--	26	--	nC

Notes:

- Package current limit.
- $L = 0.3\text{mH}, V_{GS} = 10\text{V}, R_G = 25\Omega,$ Starting $T_J = 25^\circ\text{C}.$
- Pulse test: Pulse Width $\leq 300\mu\text{s},$ duty cycle $\leq 2\%.$
- Switching time is essentially independent of operating temperature.

ORDERING INFORMATION

ORDERING CODE	PACKAGE	PACKING
TSM070NH04LCR RLG	PDFN56U	2,500pcs / 13" Reel

CHARACTERISTICS CURVES

($T_A = 25^\circ\text{C}$ unless otherwise noted)

Output Characteristics

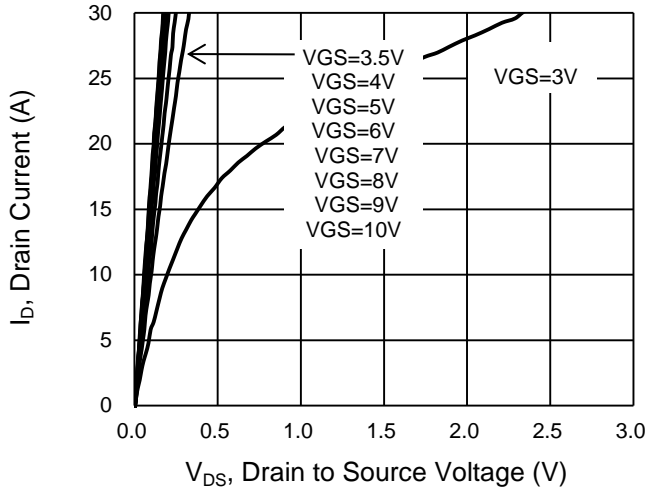

Transfer Characteristics

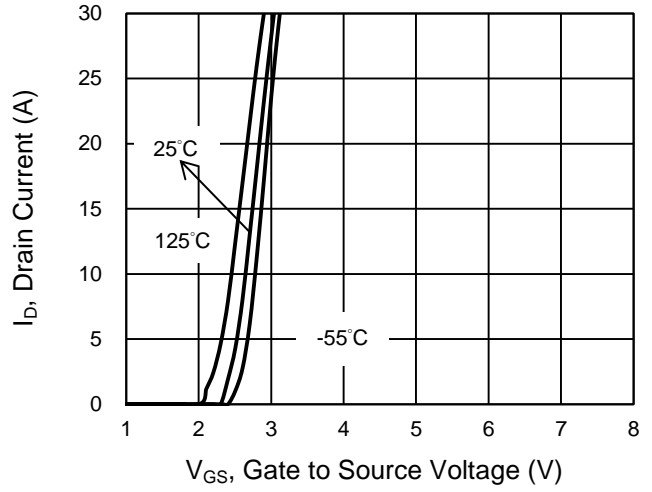

On-Resistance vs. Drain Current

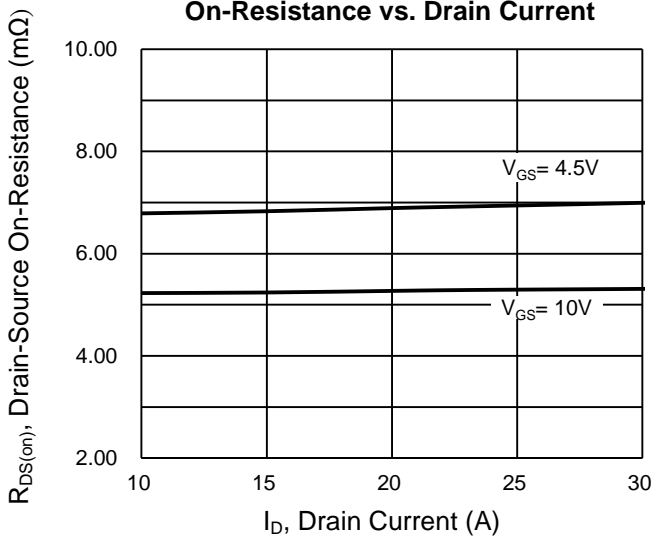

Gate-Source Voltage vs. Gate Charge

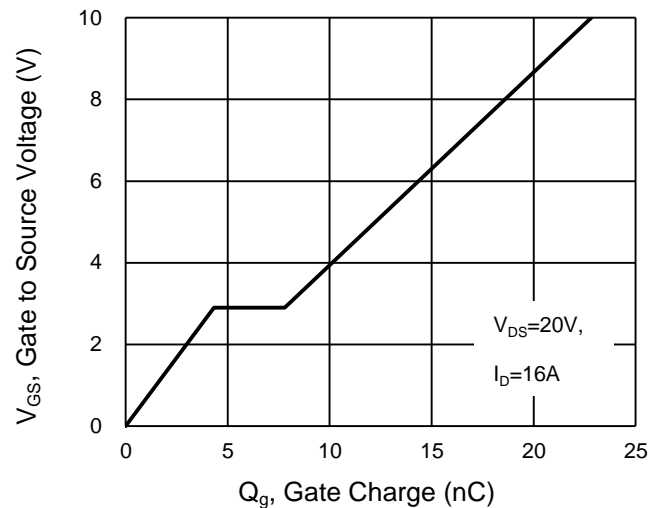

On-Resistance vs. Junction Temperature

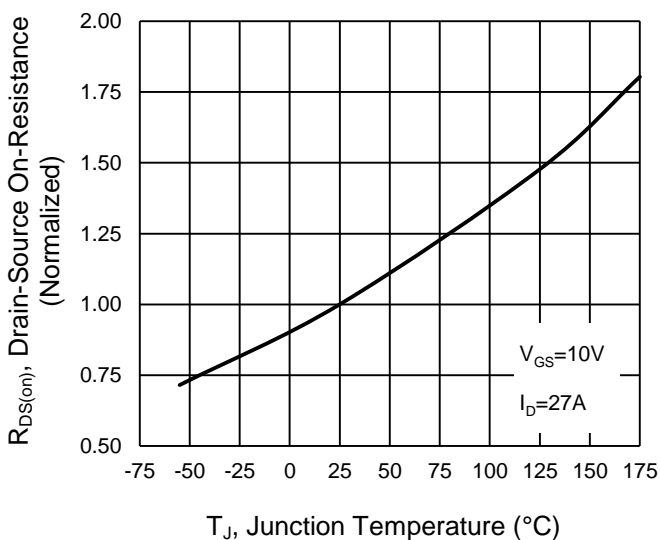

On-Resistance vs. Gate-Source Voltage

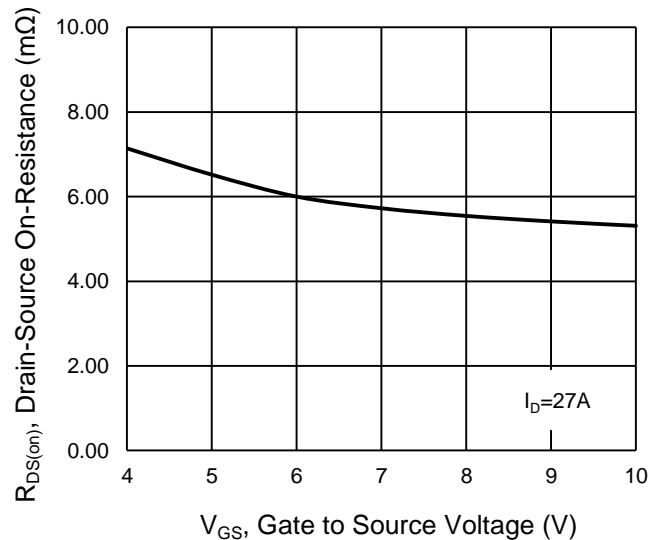

CHARACTERISTICS CURVES

($T_A = 25^\circ\text{C}$ unless otherwise noted)

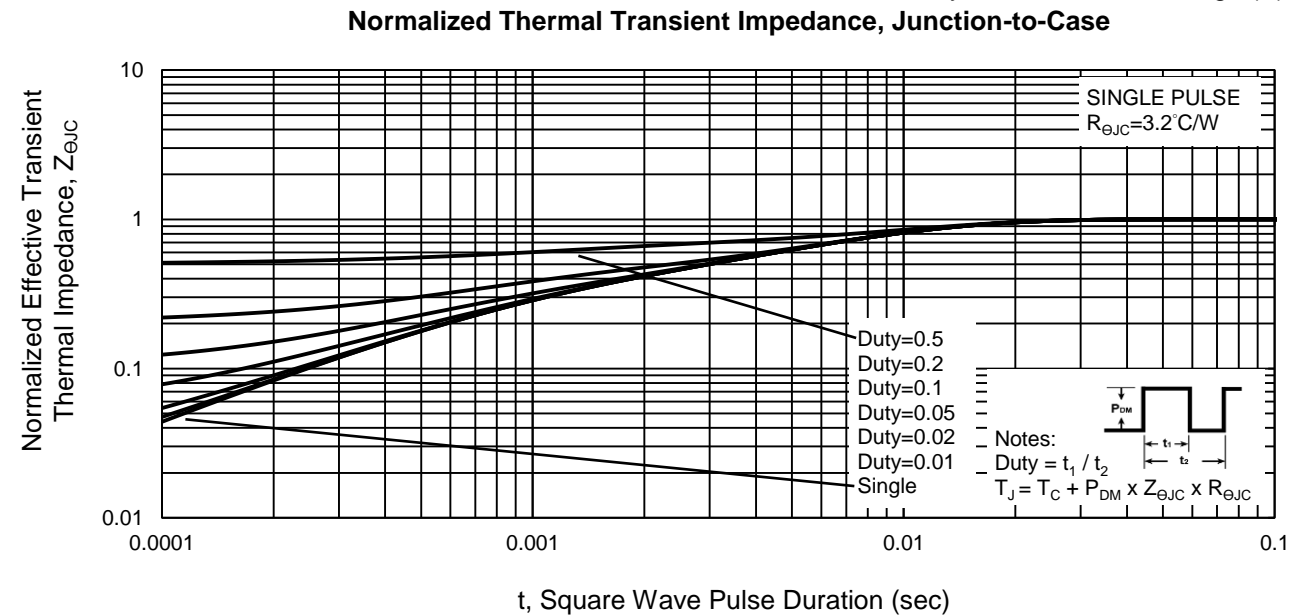
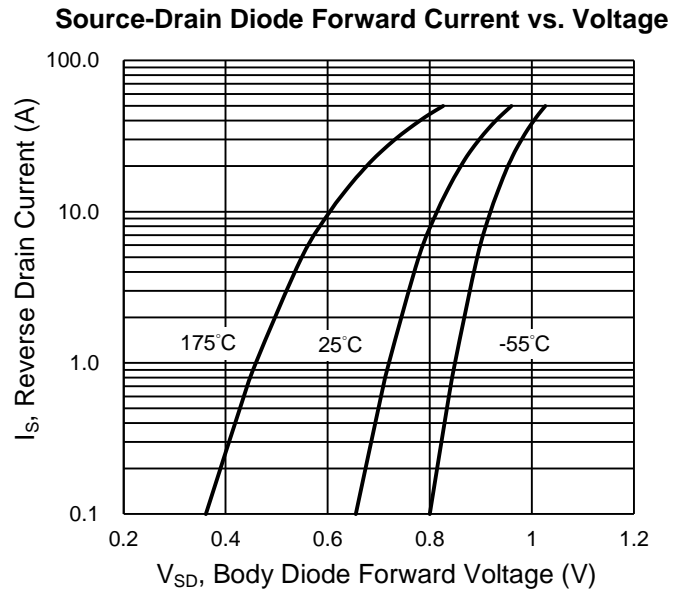
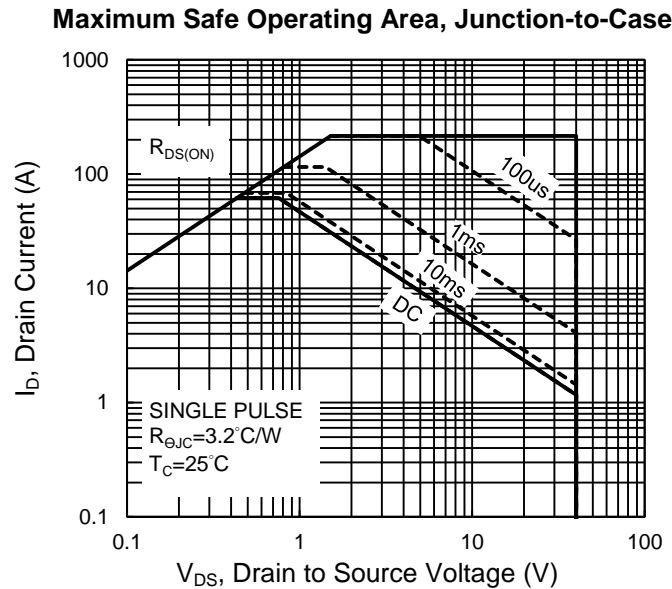
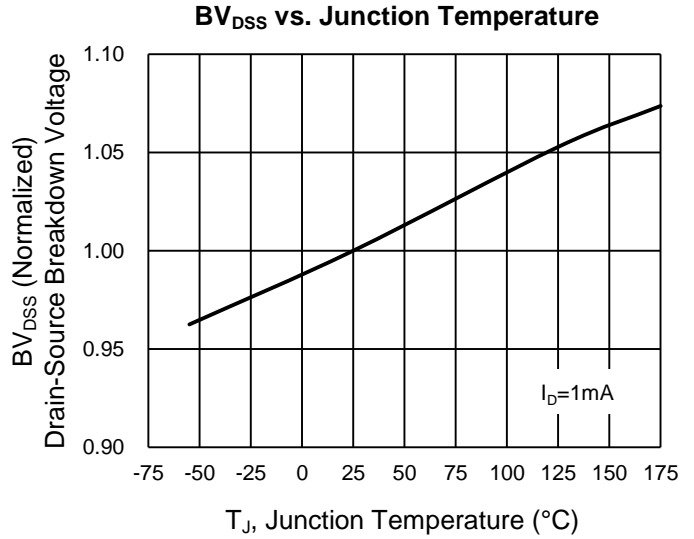
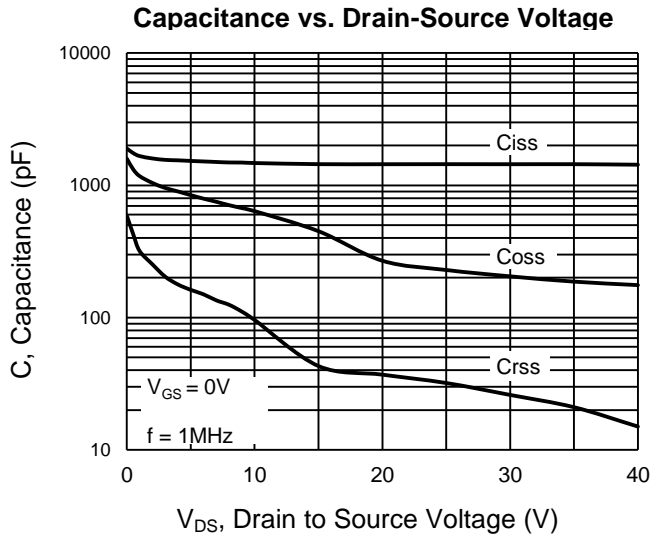

CHARACTERISTICS CURVES

($T_A = 25^\circ\text{C}$ unless otherwise noted)

Power Dissipation

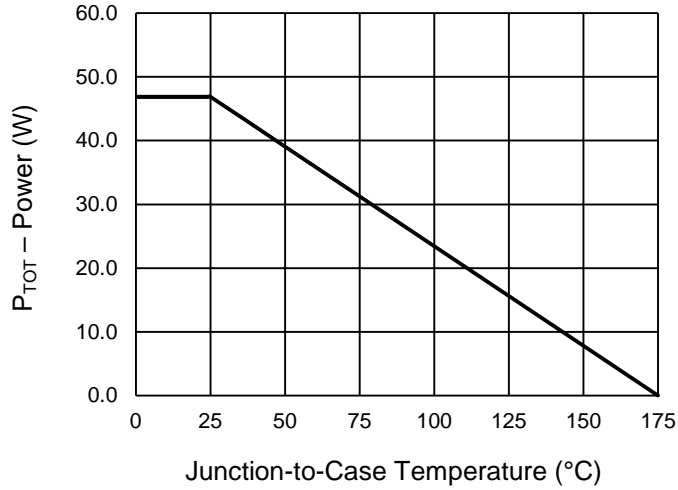

Drain Current

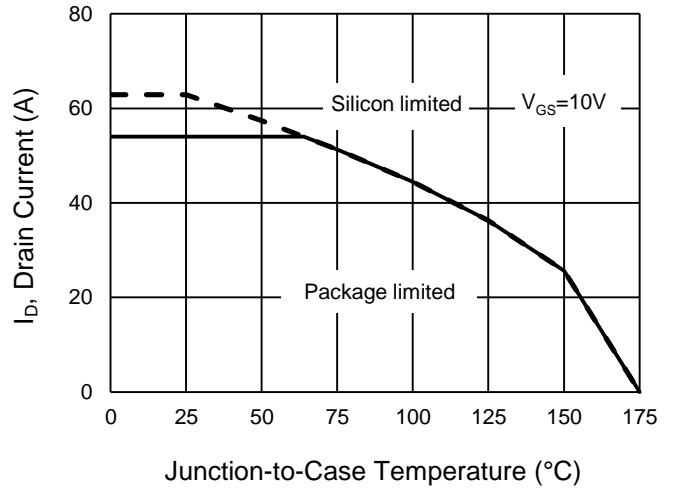

Normalized gate threshold voltage vs Temperature

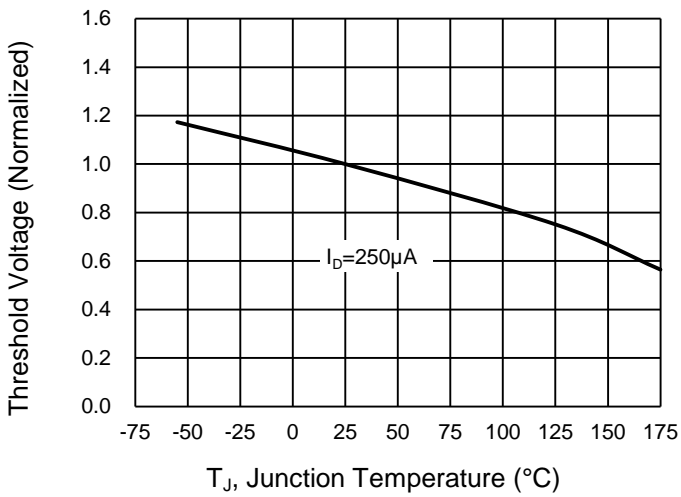

PACKAGE OUTLINE DIMENSIONS (Unit: Millimeters)

PDFN56U

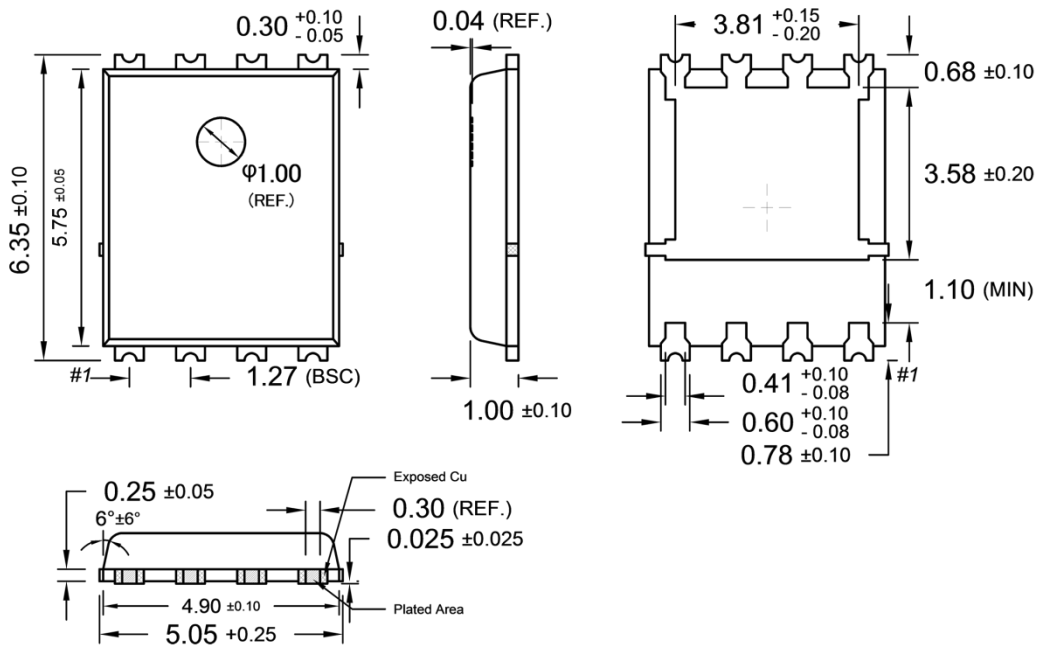

SUGGESTED PAD LAYOUT (Unit: Millimeters)

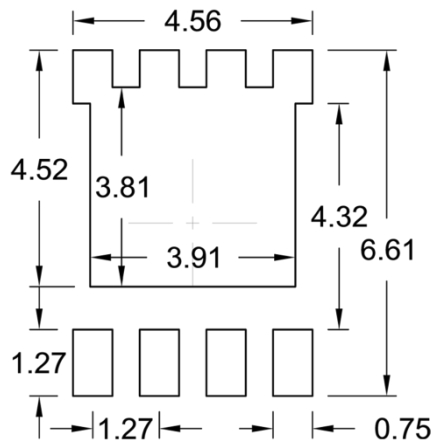

MARKING DIAGRAM

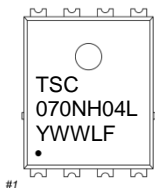

- Y** = Year Code
- WW** = Week Code (01~52)
- L** = Lot Code (1~9,A~Z)
- F** = Factory Code

Notice

Specifications of the products displayed herein are subject to change without notice. TSC or anyone on its behalf, assumes no responsibility or liability for any errors or inaccuracies.

Purchasers are solely responsible for the choice, selection, and use of TSC products and TSC assumes no liability for application assistance or the design of Purchasers' products.

Information contained herein is intended to provide a product description only. No license, express or implied, to any intellectual property rights is granted by this document. Except as provided in TSC's terms and conditions of sale for such products, TSC assumes no liability whatsoever, and disclaims any express or implied warranty, relating to sale and/or use of TSC products including liability or warranties relating to fitness for a particular purpose, merchantability, or infringement of any patent, copyright, or other intellectual property right.

The products shown herein are not designed for use in medical, life-saving, or life-sustaining applications. Customers using or selling these products for use in such applications do so at their own risk and agree to fully indemnify TSC for any damages resulting from such improper use or sale.