

Data sheet | Item number: 770-945

h-distribution connector; 4-pole; Cod. A; 1 input; 2 outputs; outputs on one side; 3 locking levers; for flying leads; black

www.wago.com/770-945

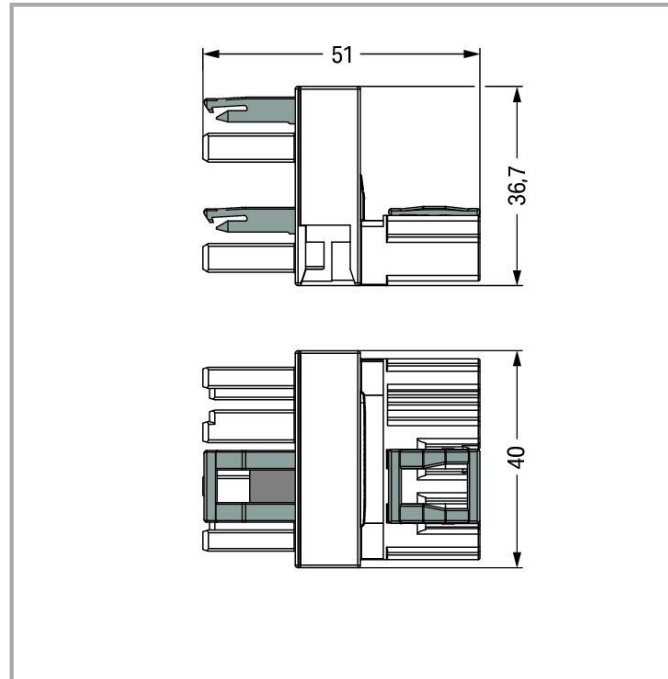

Item description

Distribution connector *WINSTA*® MIDI with protection type IP20

The *WINSTA*® MIDI distribution connector with protection type IP20 allows installation of fine-stranded and solid conductors. WAGO pluggable installation connectors can be used when specifications repeat or are distributed on a defined grid, for example for installing grid lighting or flush-mount lighting. The coding options reduce installation errors, allowing fast, secure wiring of all components. The pluggable installation connector is protected against ingress by solid objects in accordance with protection type IP20 (When mated: IP2xC (These compact connectors are not designed for use in open, easily accessible areas!)). Thanks to the color coding and mechanical A coding of *WINSTA*® MIDI pluggable installation connectors, you can clearly distinguish different circuits. This pluggable installation connector can be used for electrical currents up to 25 A. Thus the product is also suitable for high power loads. The *WINSTA*® MIDI Pluggable Connection System with Push-in CAGE CLAMP® spring pressure connection technology facilitates precise electrification. Thanks to the built-in test slot, connections can be checked even when they are plugged in. This saves time, labor, and money.

Subject to changes. Please also observe the further product documentation!

WAGO GmbH & Co. KG
Hansastr. 27
32423 Minden
Phone: +49571 887-0 | Fax: +49571 887-169
Email: info.de@wago.com | Web: www.wago.com

Do you have any questions about our products?
We are always happy to take your call at +49 (571) 887-44222.



Lower costs through fast commissioning and elimination of service expenses – solutions from WINSTA® MIDI

The WINSTA® Pluggable Connection System is perfectly tailored to the strict requirements of building installation. It makes electrical installation pluggable, and thus faster, even more reliable, and error-free. Using this pre-assembled system decreases time spent on assembly and installation errors at the construction site. Choose quality and durability – the WINSTA® MIDI pluggable installation connector with protection type IP20 from WAGO makes the electrical installation of electrical components noticeably easier.

- protection against mismatching eliminates errors
- simple circuits
- with A coding for use in a large number of general mains applications
- custom-engineered solutions
- convenient installation and commissioning

Data

Electrical data

Ratings per IEC/EN

Ratings per	IEC/EN 60664-1
Nominal voltage (III/3)	400 V
Rated impulse voltage (III/3)	6 kV
Rated current	25 A
Legend (ratings)	(III / 3) ≙ Overvoltage category III / Pollution degree 3

Ratings per UL 1977

Note for the US market	Some versions may also be used for current interruption in accordance with the UL certificate in select applications with currents below 16 A and voltages up to 600 V. For further information, please contact your local sales office.
Rated voltage (UL 1977)	600 V
Rated current UL 1977	23 A

General

Note on contact resistance	approx. 1 mΩ of contact resistance approx. 0.25 mΩ contact transition plug/socket
----------------------------	--

Subject to changes. Please also observe the further product documentation!



Connection data

Total number of potentials	4
PE function	Preceding PE contact

Connection 1

Pole number	4
-------------	---

Physical data

Pin spacing	10 mm / 0.394 inches
Width	40 mm / 1.575 inches
Height	36.7 mm / 1.445 inches
Depth	51 mm / 2.008 inches

Mechanical Data

Application	General mains applications
Coding	A
Marking	N $\frac{2}{L}$ 1/L'
Potential marking	N $\frac{2}{L}$ 1/L'
Mating force of a plug-in connection	approx. 20 ... 70 N (depending on pole number)
Retention force of a plug-in connection	When locked: > 80 N
Unmating force of a plug-in connection	Unlocked: approx. 20 ... 70 N (depending on pole number)
Number of mating cycles	200, without resistive load
Type of distribution box	h-distribution connector, outputs on one side
Protection type	IP20; When mated: IP2xC (These compact connectors are not designed for use in open, easily accessible areas!)
Suitable	for flying leads

Plug-in connection

Contact type (pluggable connector)	Socket/plug
Mismating protection	Yes
Note on mismating protection	All WINSTA [®] components are 100% protected against mismating when: a.) plugging different numbers of poles b.) plugging while rotated 180 c.) plugging while laterally staggered d.) plugging one pole

Subject to changes. Please also observe the further product documentation!



Locking lever	yes
Locking of plug-in connection	locking lever
Note on locking system	All connectors for mounted installations (snap-in versions for lighting fixtures or devices, all types of PCB and distribution connectors) are factory-equipped with locking levers to ensure plugs and sockets are securely locked. Additional locking levers are only required for flying leads (plug/socket).
Number of locking levers	3

Material Data

Note (material data)	Information on material specifications can be found here
Color	black
Insulation material	Polyamide (PA66)
Flammability class per UL94	V0
Contact material	Copper or copper alloy; surface-treated
Contact plating	Tin
Fire load	2.968 MJ
Weight	32 g

Environmental requirements

Processing temperature	-5 ... +40 °C
Continuous operating temperature	-35 ... +85 °C
Note on continuous operating temperature	Insulating parts for temperatures \leq 105 °C

Commercial data

Product Group	20 (Winsta)
eCl@ss 10.0	27-44-06-03
eCl@ss 9.0	27-44-06-03
ETIM 8.0	EC002567
ETIM 7.0	EC002567
PU (SPU)	25 pcs
Packaging type	box
Country of origin	DE
GTIN	4045454997229
Customs tariff number	85366990990

Subject to changes. Please also observe the further product documentation!

WAGO GmbH & Co. KG
 Hansastr. 27
 32423 Minden
 Phone: +49571 887-0 | Fax: +49571 887-169
 Email: info.de@wago.com | Web: www.wago.com

Do you have any questions about our products?
 We are always happy to take your call at +49 (571) 887-44222.

Environmental Product Compliance

RoHS Compliance Status







Compliant, No Exemption

Approvals / Certificates

General approvals

Logo	Approval	Additional Approval Text	Certificate name
	cURus Underwriters Laboratories Inc.	UL 1977	E45171

Counterpart

	Item no.770-104 Socket; with strain relief housing; 4-pole; Cod. A; 4,00 mm ² ; black	www.wago.com/770-104
	Item no.770-114 Plug; with strain relief housing; 4-pole; Cod. A; 4,00 mm ² ; black	www.wago.com/770-114
	Item no.770-214 Plug; 4-pole; Cod. A; 4,00 mm ² ; black	www.wago.com/770-214
	Item no.770-204 Socket; 4-pole; Cod. A; 4,00 mm ² ; black	www.wago.com/770-204
	Item no.771-9994/106-101 pre-assembled connecting cable; Eca; Socket/open-ended; 4-pole; Cod. A; H05VV-F 4G 1.5 mm ² ; 1 m; 1,50 mm ² ; black	www.wago.com/771-9994/106-101
	Item no.771-9994/006-101 pre-assembled interconnecting cable; Eca; Socket/plug; 4-pole; Cod. A; H05VV-F 4G 1.5 mm ² ; 1 m; 1,50 mm ² ; black	www.wago.com/771-9994/006-101
	Item no.771-9994/206-101 pre-assembled connecting cable; Eca; Plug/open-ended; 4-pole; Cod. A; H05VV-F 4G 1.5 mm ² ; 1 m; 1,50 mm ² ; black	www.wago.com/771-9994/206-101

Optional accessories

Cover

Cover

	Item no.: 770-360 Lockout cap; for plugs; 5-pole; separable; yellow	www.wago.com/770-360
--	---	--

Subject to changes. Please also observe the further product documentation!



Item no.: 770-201

Lockout cap; 12-pole, separable; for sockets; Plastic; black

www.wago.com/770-201



Item no.: 770-221

Lockout cap; 12-pole, separable; for sockets; Plastic; white

www.wago.com/770-221

Mounting

Mounting accessories



Item no.: 770-624

Mounting plate; 4-pole; for distribution connectors; Plastic; black

www.wago.com/770-624



Item no.: 770-674

Mounting plate; 4-pole; for distribution connectors; Plastic; white

www.wago.com/770-674

Downloads

Documentation

Bid Text

770-945 X81 - Datei	2019 Feb 19	xml 2.9 kB	Download
770-945 doc - Datei	2015 Mar 12	doc 23.6 kB	Download
ausschreiben.de 770-945		URL	Download

CAD/CAE-Data

CAE data

WSCAD Universe 770-945		URL	Download
ZUKEN Portal 770-945		URL	Download

CAD data

2D/3D Models 770-945		URL	Download
----------------------	--	-----	----------

Subject to changes. Please also observe the further product documentation!

Environmental Product Compliance

Compliance Search

Environmental Product Compliance 770-945

URL

Download

h-distribution connector; 4-pole; Cod. A; 1 input; 2 outputs; outputs on one side; 3 locking levers; for flying leads; black

Installation Notes

Installation

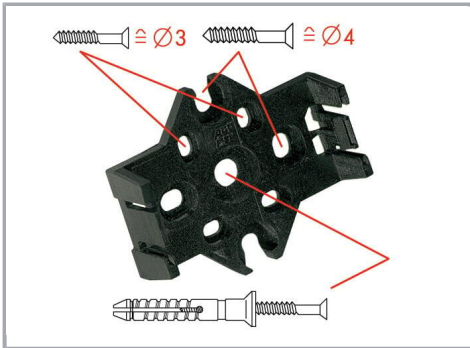

Mounting plates can be secured using commercially available screws or nail-drive anchors.



The distribution connectors snap together when attached to the mounting plate.



To release the distribution connector, unlock the latch using a screwdriver.

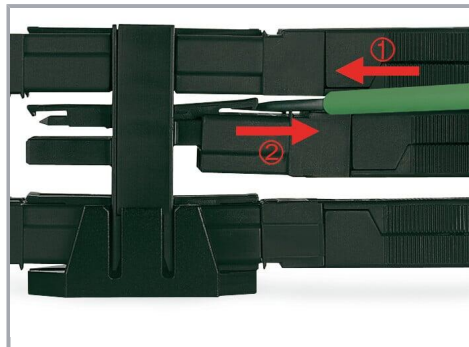

All distribution connector connections are locked and protected against accidental disconnection directly after mating. Locking of any connection is released using a screwdriver, even if all connections are used.

Product family

Subject to changes. Please also observe the further product documentation!



WINSTA® MIDI

[Show all products from the family](#)

Subject to changes. Please also observe the further product documentation!

WAGO GmbH & Co. KG
Hansastr. 27
32423 Minden
Phone: +49571 887-0 | Fax: +49571 887-169
Email: info.de@wago.com | Web: www.wago.com

Do you have any questions about our products?
We are always happy to take your call at +49 (571) 887-44222.