

Main Product Characteristics

BV_{DSS}	-20V
$R_{DS(ON)}$	16m Ω
I_D	-11A

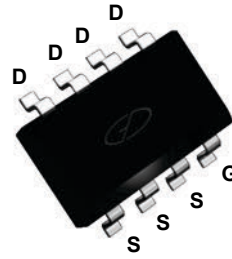

SOP-8

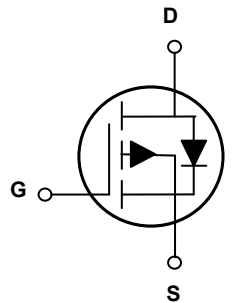

Schematic Diagram

Features and Benefits

- Advanced MOSFET process technology
- Ideal for high efficiency switched mode power supplies
- Low on-resistance with low gate charge
- Fast switching and reverse body recovery



Description

The GSFQ2305 utilizes the latest techniques to achieve high cell density and low on-resistance. These features make this device extremely efficient and reliable for use in high efficiency switch mode power supply and a wide variety of other applications.

Absolute Maximum Ratings ($T_C=25^{\circ}C$ unless otherwise specified)

Parameter	Symbol	Max.	Unit
Drain-Source Voltage	V_{DS}	-20	V
Gate-Source Voltage	V_{GS}	± 10	V
Drain Current-Continuous ($T_A=25^{\circ}C$)	I_D	-11	A
Drain Current-Continuous ($T_A=100^{\circ}C$)		-7	
Drain Current-Pulsed ¹	I_{DM}	-44	A
Power Dissipation ($T_A=25^{\circ}C$)	P_D	2.5	W
Power Dissipation-Derate above 25 $^{\circ}C$		0.02	
Thermal Resistance, Junction-to-Ambient	$R_{\theta JA}$	50	$^{\circ}C/W$
Operating Junction Temperature Range	T_J	-55 To +150	$^{\circ}C$
Storage Temperature Range	T_{STG}	-55 To +150	$^{\circ}C$

Electrical Characteristics ($T_J=25^{\circ}\text{C}$ unless otherwise specified)

Parameter	Symbol	Conditions	Min.	Typ.	Max.	Unit
On/Off Characteristics						
Drain-Source Breakdown Voltage	BV_{DSS}	$V_{GS}=0V, I_D=250\mu A$	-20	-	-	V
BV_{DSS} Temperature Coefficient	$\Delta BV_{DSS}/\Delta T_J$	Reference to 25°C , $I_D=-1\text{mA}$	-	-0.01	-	$\text{V}/^{\circ}\text{C}$
Drain-Source Leakage Current	I_{DSS}	$V_{DS}=-20V, V_{GS}=0V,$ $T_J=25^{\circ}\text{C}$	-	-	-1	μA
		$V_{DS}=-16V, V_{GS}=0V,$ $T_J=125^{\circ}\text{C}$	-	-	-10	μA
Gate-Source Leakage Current	I_{GSS}	$V_{GS}=\pm 10V, V_{DS}=0V$	-	-	± 100	nA
Static Drain-Source On-Resistance	$R_{DS(ON)}$	$V_{GS}=-10V, I_D=-6A$	-	10	12	m Ω
		$V_{GS}=-4.5V, I_D=-6A$	-	12	16	
		$V_{GS}=-2.5V, I_D=-4A$	-	16	22	
		$V_{GS}=-1.8V, I_D=-3A$	-	21	28	
Gate Threshold Voltage	$V_{GS(th)}$	$V_{GS}=V_{DS}, I_D=250\mu A$	-0.3	-0.6	-1.0	V
$V_{GS(th)}$ Temperature Coefficient	$\Delta V_{GS(th)}$		-	3	-	$\text{mV}/^{\circ}\text{C}$
Forward Transconductance	g_{fs}	$V_{DS}=-10V, I_D=-6A$	-	20	-	S
Dynamic and Switching Characteristics						
Total Gate Charge ^{2,3}	Q_g	$V_{DS}=-10V, I_D=-6A$ $V_{GS}=-4.5V$	-	27	40	nC
Gate-Source Charge ^{2,3}	Q_{gs}		-	2.4	4.8	
Gate-Drain Charge ^{2,3}	Q_{gd}		-	5.3	8	
Turn-On Delay Time ^{2,3}	$t_{d(on)}$	$V_{DD}=-10V, R_G=25\Omega$ $V_{GS}=-4.5V, I_D=-1A$	-	16.2	31	nS
Rise Time ^{2,3}	t_r		-	43.5	83	
Turn-Off Delay Time ^{2,3}	$t_{d(off)}$		-	114	217	
Fall Time ^{2,3}	t_f		-	28.8	55	
Input Capacitance	C_{iss}	$V_{DS}=-15V, V_{GS}=0V,$ $F=1\text{MHz}$	-	2320	3370	pF
Output Capacitance	C_{oss}		-	280	410	
Reverse Transfer Capacitance	C_{rss}		-	175	260	
Drain-Source Diode Characteristics and Maximum Ratings						
Continuous Source Current	I_S	$V_G=V_D=0V,$	-	-	-11	A
Pulsed Source Current	I_{SM}	Force Current	-	-	-44	A
Diode Forward Voltage	V_{SD}	$V_{GS}=0V, I_S=-1A,$ $T_J=25^{\circ}\text{C}$	-	-	-1	V

Note:

1. Repetitive rating: Pulsed width limited by maximum junction temperature.
3. Pulse test: pulse width $\leq 300\mu\text{s}$, duty cycle $\leq 2\%$.
4. Essentially independent of operating temperature.

Typical Electrical and Thermal Characteristic Curves

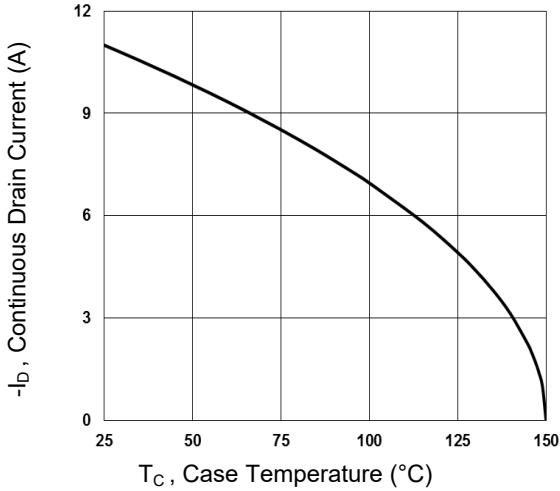

Figure 1. Continuous Drain Current vs. T_c

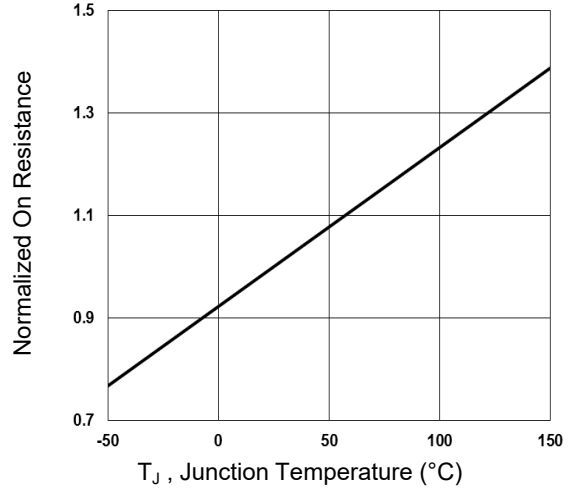

Figure 2. Normalized R_{DSON} vs. T_j

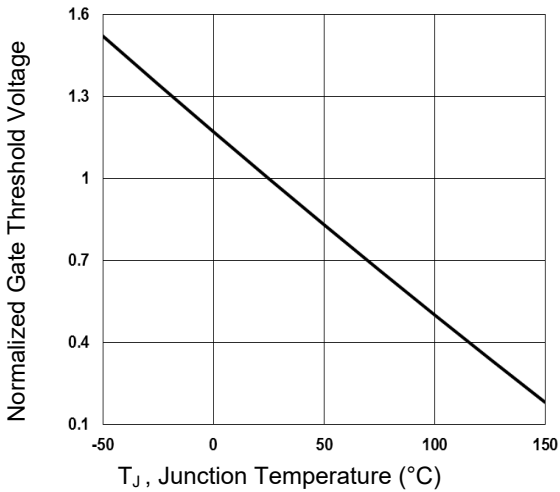

Figure 3. Normalized V_{th} vs. T_j

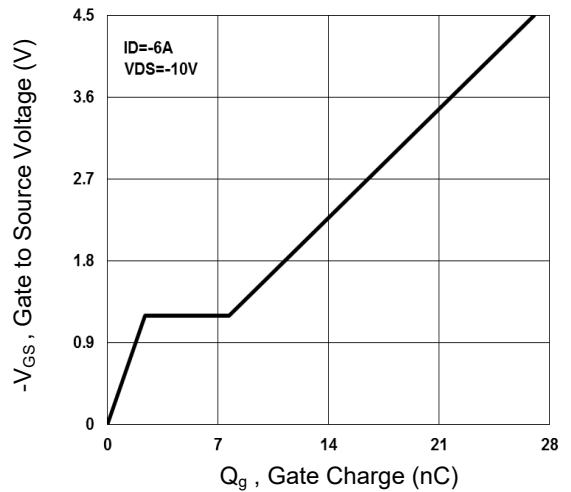

Figure 4. Gate Charge Waveform

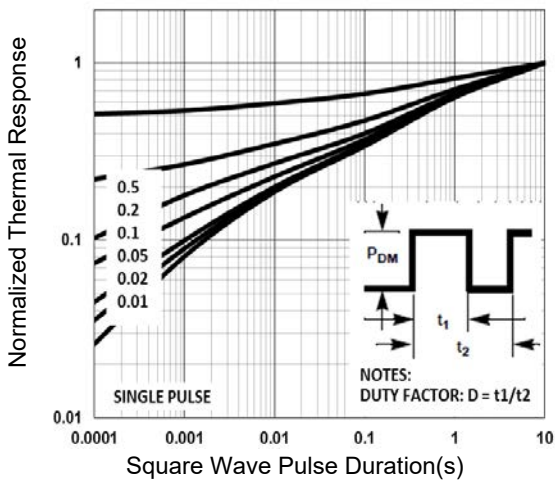

Figure 5. Normalized Transient Response

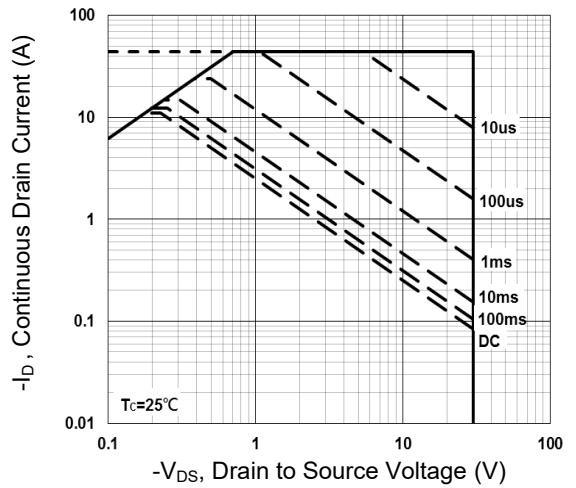

Figure 6. Maximum Safe Operation Area

Typical Electrical and Thermal Characteristic Curves

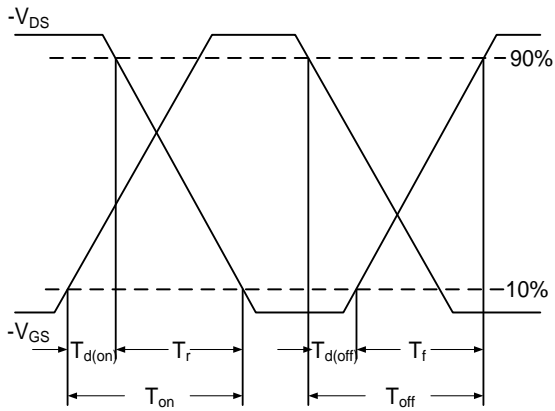

Figure 7. Switching Time Waveform

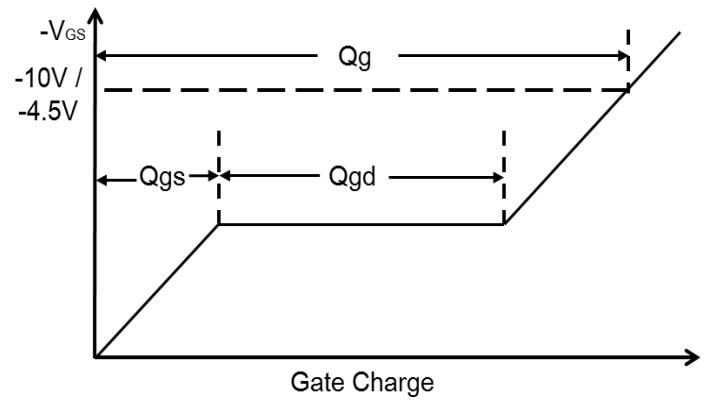
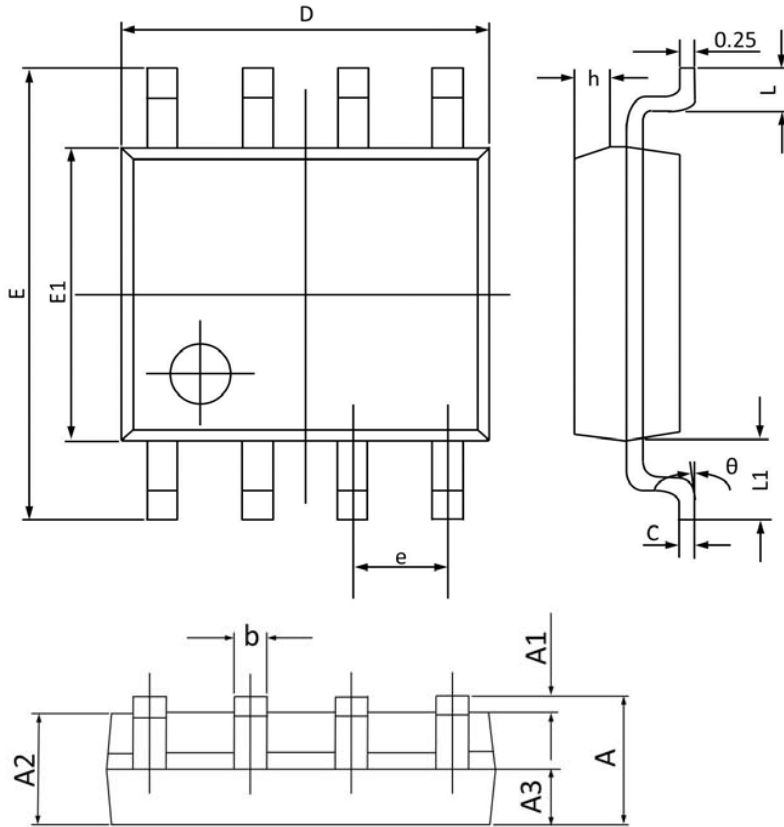

Figure 8. Gate Charge Waveform

Package Outline Dimensions

SOP-8



Symbol	Dimensions In Millimeters		Dimensions In Inches	
	Min	Max	Min	Max
A	1.350	1.800	0.053	0.069
A1	0.050	0.250	0.002	0.010
A2	1.250	1.650	0.049	0.065
A3	0.500	0.700	0.020	0.028
b	0.300	0.510	0.012	0.020
c	0.150	0.260	0.006	0.010
D	4.700	5.100	0.185	0.201
E	5.800	6.200	0.228	0.244
E1	3.700	4.100	0.146	0.161
e	1.270(BSC)		0.050(BSC)	
h	0.250	0.500	0.010	0.020
L	0.400	1.000	0.016	0.039
L1	1.050(BSC)		0.041(BSC)	
theta	0°	8°	0°	8°