

## Data sheet | Item number: 770-936

h-distribution connector; 3-pole; Cod. P; 1 input; 2 outputs; outputs on one side; 3 locking levers; for flying leads; red

[www.wago.com/770-936](http://www.wago.com/770-936)

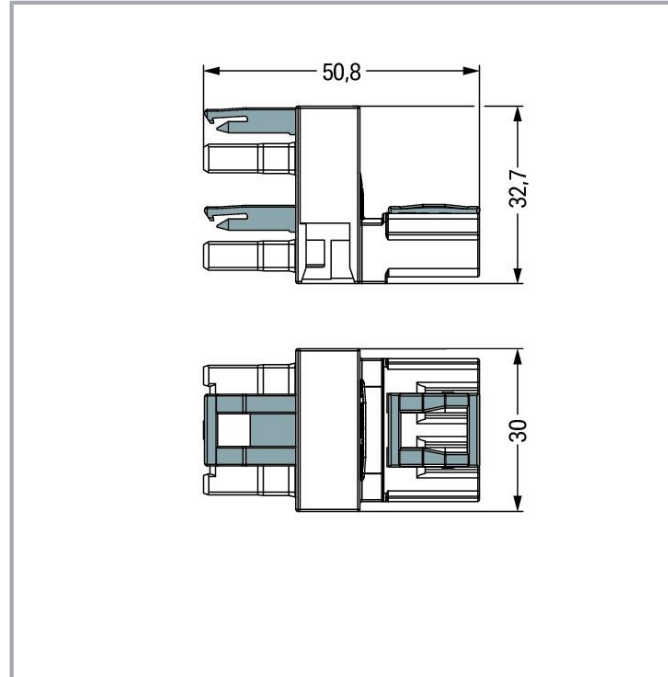
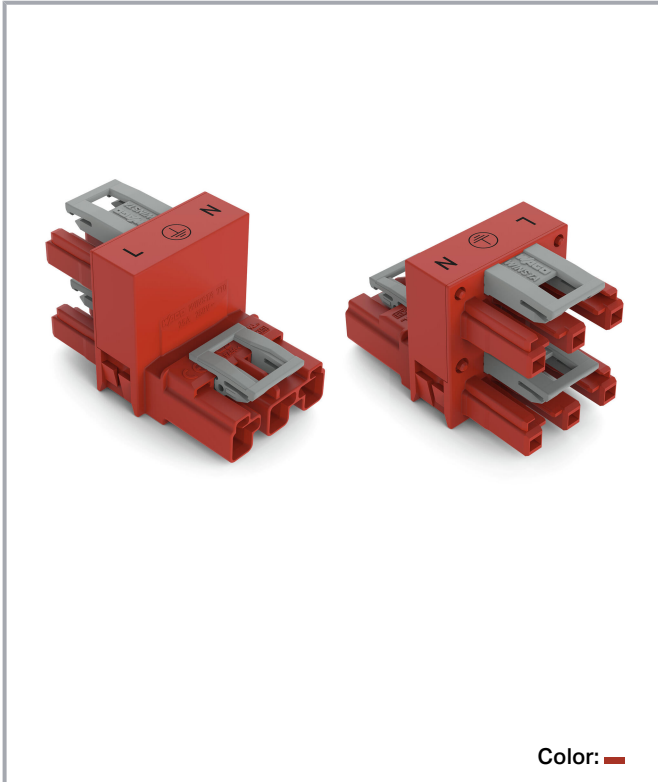

### Item description

#### Distribution connector *WINSTA*® MIDI with protection type IP20

Use effective pluggable connections instead of laborious screw connections: With the *WINSTA*® MIDI distribution connector rated current 25 A. WAGO pluggable installation connectors can be used when specifications repeat or are planned on a specified grid, for example for installing grid lighting or flush-mount lighting. The color coding and mechanical coding of the pluggable installation connector ensure error-free installation of the individual components – including protection against mismatching. The pluggable installation connector is protected in accordance with protection type IP20 (When mated: IP2xC (These compact connectors are not designed for use in open, easily accessible areas!)). This means that users' fingers will never come into contact with live contact elements. UPS applications for data exchange frequently use the red *WINSTA*® MIDI pluggable installation connectors with P coding. Important parameters in the selection of a pluggable installation connector are the rated current and voltage: They tell us about the product's domains of use. This product has a current rating of 25 A – as a result it is suitable for robust loads. The *WINSTA*® MIDI Pluggable Connection System with Push-in CAGE CLAMP® spring pressure connection technology facilitates safe electrification. Due to the included test slot, connections can be checked even when they are plugged in. This saves time, labor, and money.

Subject to changes. Please also observe the further product documentation!

WAGO GmbH & Co. KG  
Hansastr. 27  
32423 Minden  
Phone: +49571 887-0 | Fax: +49571 887-169  
Email: [info.de@wago.com](mailto:info.de@wago.com) | Web: [www.wago.com](http://www.wago.com)

Do you have any questions about our products?  
We are always happy to take your call at +49 (571) 887-44222.



## WINSTA® MIDI solutions for your electrical installation – protected against mismatching and maintenance-free

WINSTA® is the pluggable connection system that is ideally tailored to the strict requirements of electrical installation. It allows error-free installation of cables and components, quickly and reliably. Choose quality and durability – the WINSTA® MIDI pluggable installation connector with protection against mismatching from WAGO makes the electrical installation of electrical components substantially easier.

- pluggable installation connectors with protection against mismatching
- pre-assembled versions
- for UPS applications
- flexible installation to save space
- quick replacement of defective units during ongoing operation

### Data

#### Electrical data

#### Ratings per IEC/EN

Ratings per	IEC/EN 60664-1
Nominal voltage (III/3)	250 V
Rated impulse voltage (III/3)	4 kV
Rated current	25 A
Legend (ratings)	(III / 3) ≙ Overvoltage category III / Pollution degree 3

#### Ratings per UL 1977

Note for the US market	Some versions may also be used for current interruption in accordance with the UL certificate in select applications with currents below 16 A and voltages up to 600 V. For further information, please contact your local sales office.
Rated voltage (UL 1977)	600 V
Rated current UL 1977	23 A

### General

Note on contact resistance	approx. 1 mΩ of contact resistance approx. 0.25 mΩ contact transition plug/socket
----------------------------	--

Subject to changes. Please also observe the further product documentation!



## Connection data

Total number of potentials	3
PE function	Preceding PE contact

## Connection 1

Pole number	3
-------------	---

## Physical data

Pin spacing	10 mm / 0.394 inches
Width	30 mm / 1.181 inches
Height	32.7 mm / 1.287 inches
Depth	51 mm / 2.008 inches

## Mechanical Data

Application	EDV (UPS)
Coding	P
Variable coding	No
Marking	L ⊥ N
Potential marking	L ⊥ N
Mating force of a plug-in connection	approx. 20 ... 70 N (depending on pole number)
Retention force of a plug-in connection	When locked: > 80 N
Unmating force of a plug-in connection	Unlocked: approx. 20 ... 70 N (depending on pole number)
Number of mating cycles	200, without resistive load
Type of distribution box	h-distribution connector, outputs on one side
Protection type	IP20; When mated: IP2xC (These compact connectors are not designed for use in open, easily accessible areas!)
Suitable	for flying leads

## Plug-in connection

Contact type (pluggable connector)	Socket/plug
Mismating protection	Yes
Note on mismating protection	All <b>WINSTA</b> <sup>®</sup> components are 100% protected against mismating when: a.) plugging different numbers of poles b.) plugging while rotated 180

Subject to changes. Please also observe the further product documentation!



	c.) plugging while laterally staggered d.) plugging one pole
Locking lever	yes
Locking of plug-in connection	locking lever
Note on locking system	All connectors for mounted installations (snap-in versions for lighting fixtures or devices, all types of PCB and distribution connectors) are factory-equipped with locking levers to ensure plugs and sockets are securely locked. Additional locking levers are only required for flying leads (plug/socket).

## Material Data

Note (material data)	Information on material specifications can be found here
Color	red
Insulation material	Polyamide (PA66)
Flammability class per UL94	V0
Contact material	Copper or copper alloy; surface-treated
Contact plating	Tin
Fire load	0.386 MJ
Weight	22.7 g

## Environmental requirements

Processing temperature	-5 ... +40 °C
Continuous operating temperature	-35 ... +85 °C
Note on continuous operating temperature	Insulating parts for temperatures $\leq$ 105 °C

## Commercial data

Product Group	20 (Winsta)
eCl@ss 10.0	27-44-06-03
eCl@ss 9.0	27-44-06-03
ETIM 8.0	EC002567
ETIM 7.0	EC002567
PU (SPU)	50 pcs
Packaging type	box
Country of origin	DE
GTIN	4045454419981
Customs tariff number	85366990990

Subject to changes. Please also observe the further product documentation!

WAGO GmbH & Co. KG  
 Hansastr. 27  
 32423 Minden  
 Phone: +49571 887-0 | Fax: +49571 887-169  
 Email: [info.de@wago.com](mailto:info.de@wago.com) | Web: [www.wago.com](http://www.wago.com)

Do you have any questions about our products?  
 We are always happy to take your call at +49 (571) 887-44222.

## Environmental Product Compliance

RoHS Compliance Status





Compliant, No Exemption

## Approvals / Certificates

### General approvals

Logo	Approval	Additional Approval Text	Certificate name
	cURus Underwriters Laboratories Inc.	UL 1977	E45171



## Counterpart

	<b>Item no.770-1303</b> Socket; 3-pole; Cod. P; 4,00 mm <sup>2</sup> ; red	<a href="http://www.wago.com/770-1303">www.wago.com/770-1303</a>
	<b>Item no.770-1313</b> Plug; 3-pole; Cod. P; 4,00 mm <sup>2</sup> ; red	<a href="http://www.wago.com/770-1313">www.wago.com/770-1313</a>
	<b>Item no.771-9973/006-101</b> pre-assembled interconnecting cable; Eca; Socket/plug; 3-pole; Cod. P; H05VV-F 3G 1.5 mm <sup>2</sup> ; 1 m; 1,50 mm <sup>2</sup> ; red	<a href="http://www.wago.com/771-9973/006-101">www.wago.com/771-9973/006-101</a>
	<b>Item no.771-9973/206-101</b> pre-assembled connecting cable; Eca; Plug/open-ended; 3-pole; Cod. P; H05VV-F 3G 1.5 mm <sup>2</sup> ; 1 m; 1,50 mm <sup>2</sup> ; red	<a href="http://www.wago.com/771-9973/206-101">www.wago.com/771-9973/206-101</a>
	<b>Item no.771-9973/106-101</b> pre-assembled connecting cable; Eca; Socket/open-ended; 3-pole; Cod. P; H05VV-F 3G 1.5 mm <sup>2</sup> ; 1 m; 1,50 mm <sup>2</sup> ; red	<a href="http://www.wago.com/771-9973/106-101">www.wago.com/771-9973/106-101</a>

## Optional accessories

### Mounting

#### Mounting accessories

	<b>Item no.: 770-623</b> Mounting plate; 3-pole; for distribution connectors; Plastic; black	<a href="http://www.wago.com/770-623">www.wago.com/770-623</a>
	<b>Item no.: 770-673</b> Mounting plate; 3-pole; for distribution connectors; Plastic; white	<a href="http://www.wago.com/770-673">www.wago.com/770-673</a>

### Cover

Subject to changes. Please also observe the further product documentation!

WAGO GmbH &amp; Co. KG

Hansastr. 27

32423 Minden

Phone: +49571 887-0 | Fax: +49571 887-169

Email: [info.de@wago.com](mailto:info.de@wago.com) | Web: [www.wago.com](http://www.wago.com)

Do you have any questions about our products?

We are always happy to take your call at +49 (571) 887-44222.

Cover



**Item no.: 770-360**  
Lockout cap; for plugs; 5-pole; separable; yellow

[www.wago.com/770-360](http://www.wago.com/770-360)



**Item no.: 770-201**  
Lockout cap; 12-pole, separable; for sockets; Plastic; black

[www.wago.com/770-201](http://www.wago.com/770-201)



**Item no.: 770-221**  
Lockout cap; 12-pole, separable; for sockets; Plastic; white

[www.wago.com/770-221](http://www.wago.com/770-221)

**Downloads**

**Documentation**

**Bid Text**

770-936 X81 - Datei	2019 Feb 19	xml 2.9 kB	Download
770-936 doc - Datei	2015 Mar 12	doc 23.6 kB	Download

**CAD/CAE-Data**

**CAE data**

EPLAN Data Portal 770-936	URL	Download
WSCAD Universe 770-936	URL	Download

**Environmental Product Compliance**

**Compliance Search**

Environmental Product Compliance 770-936 h-distribution connector; 3-pole; Cod. P; 1 input; 2 outputs; outputs on one side; 3 locking levers; for flying leads; red	URL	Download
--	-----	----------

**Installation Notes**

**Installation**

Subject to changes. Please also observe the further product documentation!

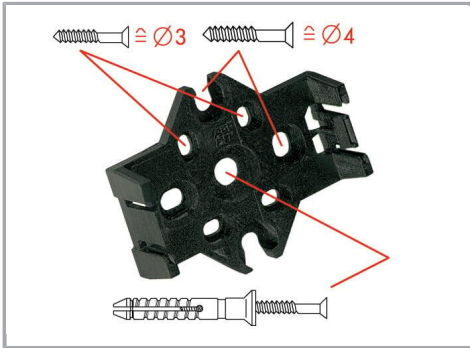

Mounting plates can be secured using commercially available screws or nail-drive anchors.



The distribution connectors snap together when attached to the mounting plate.



To release the distribution connector, unlock the latch using a screwdriver.

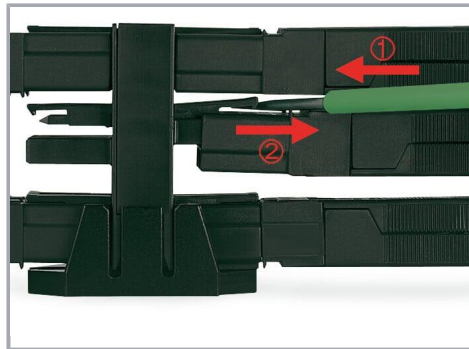

All distribution connector connections are locked and protected against accidental disconnection directly after mating. Locking of any connection is released using a screwdriver, even if all connections are used.

## Product family

**WINSTA® MIDI**

[Show all products from the family](#)

Subject to changes. Please also observe the further product documentation!