

Schematic for the NCP170AXV180GEVB Evaluation Board

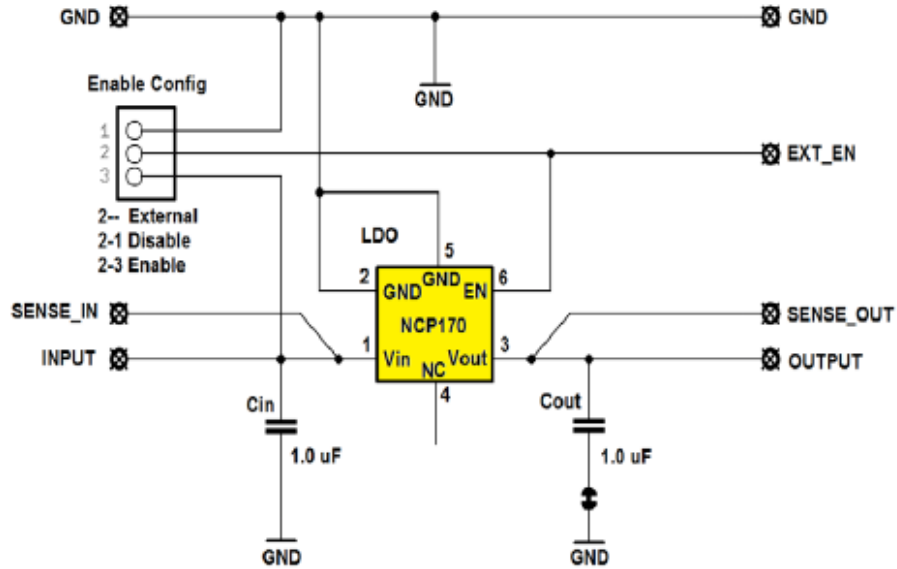

Programming I/F

