

**Data sheet | Item number: 2002-1707**

3-conductor ground terminal block; 2.5 mm<sup>2</sup>; side and center marking; for DIN-rail 35 x 15 and 35 x 7.5; Push-in CAGE CLAMP®; 2,50 mm<sup>2</sup>; green-yellow



[www.wago.com/2002-1707](http://www.wago.com/2002-1707)



Color: 

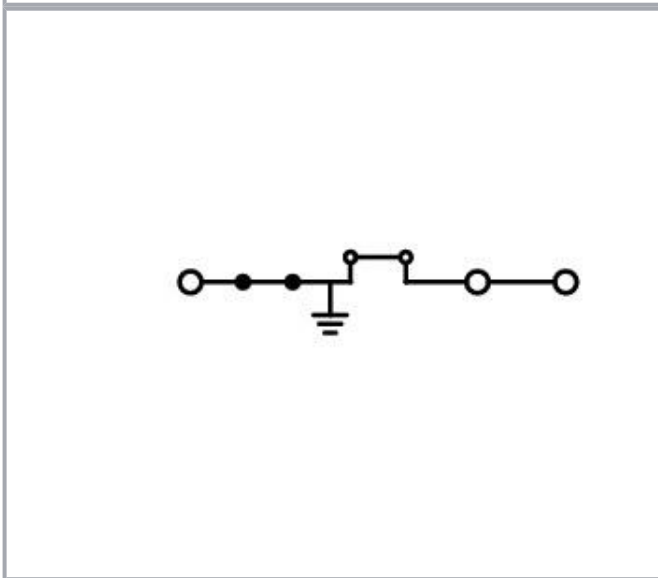
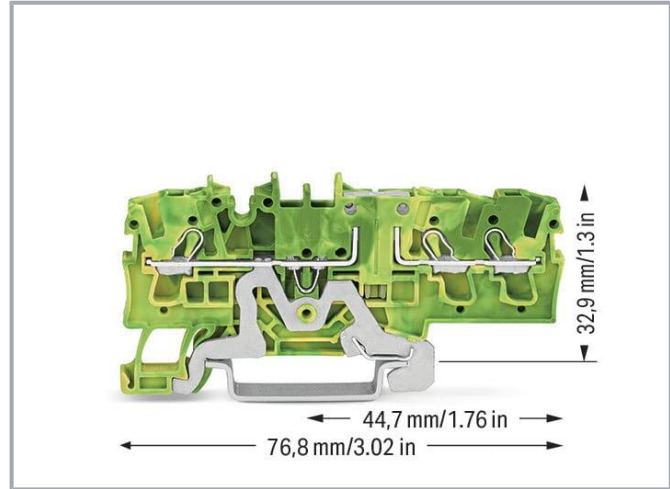

**Data**

**Electrical data**

**Ratings per IEC/EN**

Ratings per

IEC/EN 60947-7-2

Subject to changes. Please also observe the further product documentation!

WAGO GmbH & Co. KG  
Hansastr. 27  
32423 Minden  
Phone: +49571 887-0 | Fax: +49571 887-169  
Email: [info.de@wago.com](mailto:info.de@wago.com) | Web: [www.wago.com](http://www.wago.com)

Do you have any questions about our products?  
We are always happy to take your call at +49 (571) 887-44222.



## Ex information

Reference hazardous areas

See "Downloads – Documentation – Additional Information: Technical Section; Technical Explications"

## Connection data

Connection points	3
Total number of potentials	1
Number of levels	1
Number of jumper slots	2

## Connection 1

Connection technology	Push-in CAGE CLAMP®
Actuation type	Operating tool
Connectable conductor materials	Copper
Nominal cross-section	2.5 mm <sup>2</sup>
Solid conductor	0.25 ... 4 mm <sup>2</sup> / 22 ... 12 AWG
Solid conductor; push-in termination	0.75 ... 4 mm <sup>2</sup> / 18 ... 12 AWG
Fine-stranded conductor	0.25 ... 4 mm <sup>2</sup> / 22 ... 12 AWG
Fine-stranded conductor; with insulated ferrule	0.25 ... 2.5 mm <sup>2</sup> / 22 ... 14 AWG
Fine-stranded conductor; with ferrule; push-in termination	1 ... 2.5 mm <sup>2</sup> / 18 ... 14 AWG
Note (conductor cross-section)	Depending on the conductor characteristic, a conductor with a smaller cross-section can also be inserted via push-in termination.
Strip length	10 ... 12 mm / 0.39 ... 0.47 inches
Wiring direction	Front-entry wiring

## Physical data

Width	5.2 mm / 0.205 inches
Height	76.8 mm / 3.024 inches
Depth from upper-edge of DIN-rail	32.9 mm / 1.295 inches

## Mechanical Data

Mounting type	DIN-35 rail
Marking level	Center/side marking

Subject to changes. Please also observe the further product documentation!

WAGO GmbH & Co. KG  
 Hansastr. 27  
 32423 Minden  
 Phone: +49571 887-0 | Fax: +49571 887-169  
 Email: [info.de@wago.com](mailto:info.de@wago.com) | Web: [www.wago.com](http://www.wago.com)

Do you have any questions about our products?  
 We are always happy to take your call at +49 (571) 887-44222.



## Material Data

Note (material data)

Information on material specifications can be found here

Color	green-yellow
Material group	I
Insulation material	Polyamide (PA66)
Flammability class per UL94	V0
Fire load	0.164 MJ
Weight	11.4 g

## Environmental requirements

Processing temperature	-35 ... +85 °C
Continuous operating temperature	-60 ... +105 °C

## Commercial data

Product Group	22 (TOPJOB S)
eCl@ss 10.0	27-14-11-20
eCl@ss 9.0	27-14-11-41
ETIM 8.0	EC000901
ETIM 7.0	EC000901
PU (SPU)	50 pcs
Packaging type	box
Country of origin	CN
GTIN	4050821707516
Customs tariff number	85369010000

## Environmental Product Compliance

RoHS Compliance Status	Compliant, No Exemption
------------------------	-------------------------



## Approvals / Certificates

### General approvals

Logo	Approval	Additional Approval Text	Certificate name
	CCA DEKRA Certification B.V.	EN 60947	71-120369

Subject to changes. Please also observe the further product documentation!





	<b>CCA</b> DEKRA Certification B.V.	EN 60947	NTR NL 7892
	<b>CCC</b> CNEX	GB/T 3836.3	2020312313000180 (Ex ec IIC Gc)
	<b>CSA</b> DEKRA Certification B.V.	C22.2 No. 158	1536069

## Declarations of conformity and manufacturer's declarations

Logo	Approval	Additional Approval Text	Certificate name
	<b>Railway</b> WAGO GmbH & Co. KG	-	Railway Ready

## Approvals for marine applications

Logo	Approval	Additional Approval Text	Certificate name
	<b>ABS</b> American Bureau of Shipping	EN 60947	20- HG1941090- PDA
	<b>DNV GL</b> Det Norske Veritas, Germanischer Lloyd	-	TAE00001V2

## Approvals for hazardous areas

Logo	Approval	Additional Approval Text	Certificate name
	<b>AEx</b> Underwriters Laboratories Inc.	UL 60079	E185892 (AEx eb IIC resp. Ex eb IIC)
	<b>ATEX</b>	-	KIWA 17ATEX0030

Subject to changes. Please also observe the further product documentation!



KIWA Netherlands B.V.

U

CCC  
CNEX

GB/T 3836.3

2020312313000180  
(Ex ec IIC Gc)IECEX  
KIWA Netherlands B.V.

-

IECEX KIWA 17.0014  
U (Ex ec IIC Gc)

## Required accessories

### End plate

End plate

**Item no.: 2002-1791**

End and intermediate plate; 1 mm thick; gray

[www.wago.com/2002-1791](http://www.wago.com/2002-1791)

**Item no.: 2002-1792**







End and intermediate plate; 1 mm thick; orange

[www.wago.com/2002-1792](http://www.wago.com/2002-1792)

## Optional accessories

### Ferrule

Ferrule

**Item no.: 216-241**
Ferrule; Sleeve for 0.5 mm<sup>2</sup> / 20 AWG; insulated; electro-tin plated; electrolytic copper; gastight crimped; acc. to DIN 46228, Part 4/09.90; white[www.wago.com/216-241](http://www.wago.com/216-241)

**Item no.: 216-242**
Ferrule; Sleeve for 0.75 mm<sup>2</sup> / 18 AWG; insulated; electro-tin plated; electrolytic copper; gastight crimped; acc. to DIN 46228, Part 4/09.90; gray[www.wago.com/216-242](http://www.wago.com/216-242)

**Item no.: 216-243**
Ferrule; Sleeve for 1 mm<sup>2</sup> / AWG 18; insulated; electro-tin plated; electrolytic copper; gastight crimped; acc. to DIN 46228, Part 4/09.90; red[www.wago.com/216-243](http://www.wago.com/216-243)

**Item no.: 216-244**
Ferrule; Sleeve for 1.5 mm<sup>2</sup> / AWG 16; insulated; electro-tin plated; electrolytic copper; gastight crimped; acc. to DIN 46228, Part 4/09.90; black[www.wago.com/216-244](http://www.wago.com/216-244)

**Item no.: 216-263**
Ferrule; Sleeve for 1 mm<sup>2</sup> / AWG 18; insulated; electro-tin plated; electrolytic copper; gastight crimped; acc. to DIN 46228, Part 4/09.90; red[www.wago.com/216-263](http://www.wago.com/216-263)

**Item no.: 216-246**
Ferrule; Sleeve for 2.5 mm<sup>2</sup> / AWG 14; insulated; electro-tin plated; electrolytic copper; gastight crimped; acc. to DIN 46228, Part 4/09.90; blue[www.wago.com/216-246](http://www.wago.com/216-246)

Subject to changes. Please also observe the further product documentation!

WAGO GmbH &amp; Co. KG

Hansastr. 27













32423 Minden

Phone: +49571 887-0 | Fax: +49571 887-169

Email: [info.de@wago.com](mailto:info.de@wago.com) | Web: [www.wago.com](http://www.wago.com)

Do you have any questions about our products?

We are always happy to take your call at +49 (571) 887-44222.

	<p><b>Item no.: 216-266</b>                      Ferrule; Sleeve for 2.5 mm<sup>2</sup> / AWG 14; insulated; electro-tin plated; electrolytic copper; gastight crimped; acc. to DIN 46228, Part 4/09.90; blue</p>	<a href="http://www.wago.com/216-266">www.wago.com/216-266</a>
	<p><b>Item no.: 216-264</b>                      Ferrule; Sleeve for 1.5 mm<sup>2</sup> / AWG 16; insulated; electro-tin plated; electrolytic copper; gastight crimped; acc. to DIN 46228, Part 4/09.90; black</p>	<a href="http://www.wago.com/216-264">www.wago.com/216-264</a>
	<p><b>Item no.: 216-262</b>                      Ferrule; Sleeve for 0.75 mm<sup>2</sup> / 18 AWG; insulated; electro-tin plated; electrolytic copper; gastight crimped; acc. to DIN 46228, Part 4/09.90; gray</p>	<a href="http://www.wago.com/216-262">www.wago.com/216-262</a>
<b>Insulation stop</b>		
Insulation stop		
	<p><b>Item no.: 2002-171</b>                      Insulation stop; 0.25 - 0.5 mm<sup>2</sup>; 5 pieces/strip; light gray</p>	<a href="http://www.wago.com/2002-171">www.wago.com/2002-171</a>
	<p><b>Item no.: 2002-172</b>                      Insulation stop; 0.75 - 1 mm<sup>2</sup>; 5 pieces/strip; dark gray</p>	<a href="http://www.wago.com/2002-172">www.wago.com/2002-172</a>
<b>Carrier rail</b>		
Mounting accessories		
	<p><b>Item no.: 210-197</b>                      Steel carrier rail; 35 x 15 mm; 1.5 mm thick; 2 m long; slotted; similar to EN 60715; silver-colored</p>	<a href="http://www.wago.com/210-197">www.wago.com/210-197</a>
	<p><b>Item no.: 210-198</b>                      Copper carrier rail; 35 x 15 mm; 2.3 mm thick; 2 m long; unslotted; according to EN 60715; copper-colored</p>	<a href="http://www.wago.com/210-198">www.wago.com/210-198</a>
	<p><b>Item no.: 210-504</b>                      Steel carrier rail; 35 x 7.5 mm; 1 mm thick; 2 m long; slotted; galvanized; according to EN 60715; silver-colored</p>	<a href="http://www.wago.com/210-504">www.wago.com/210-504</a>
	<p><b>Item no.: 210-505</b>                      Steel carrier rail; 35 x 7.5 mm; 1 mm thick; 2 m long; unslotted; galvanized; according to EN 60715; silver-colored</p>	<a href="http://www.wago.com/210-505">www.wago.com/210-505</a>
	<p><b>Item no.: 210-506</b>                      Steel carrier rail; 35 x 15 mm; 1.5 mm thick; 2 m long; unslotted; galvanized; similar to EN 60715; silver-colored</p>	<a href="http://www.wago.com/210-506">www.wago.com/210-506</a>
	<p><b>Item no.: 210-508</b>                      Steel carrier rail; 35 x 15 mm; 1.5 mm thick; 2 m long; slotted; galvanized; similar to EN 60715; silver-colored</p>	<a href="http://www.wago.com/210-508">www.wago.com/210-508</a>
	<p><b>Item no.: 210-113</b>                      Steel carrier rail; 35 x 7.5 mm; 1 mm thick; 2 m long; unslotted; according to EN 60715; silver-colored</p>	<a href="http://www.wago.com/210-113">www.wago.com/210-113</a>
	<p><b>Item no.: 210-118</b>                      Steel carrier rail; 35 x 15 mm; 2.3 mm thick; 2 m long; unslotted; according to EN 60715; silver-colored</p>	<a href="http://www.wago.com/210-118">www.wago.com/210-118</a>
	<p><b>Item no.: 210-112</b>                      Steel carrier rail; 35 x 7.5 mm; 1 mm thick; 2 m long; slotted; according to EN 60715; "Hole width 25 mm;</p>	<a href="http://www.wago.com/210-112">www.wago.com/210-112</a>

Subject to changes. Please also observe the further product documentation!

silver-colored



**Item no.: 210-114**

Steel carrier rail; 35 x 15 mm; 1.5 mm thick; 2 m long; unslotted; similar to EN 60715; silver-colored

[www.wago.com/210-114](http://www.wago.com/210-114)



**Item no.: 210-115**

Steel carrier rail; 35 x 7.5 mm; 1 mm thick; 2 m long; slotted; according to EN 60715; "Hole width 18 mm; silver-colored

[www.wago.com/210-115](http://www.wago.com/210-115)

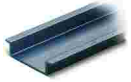

**Item no.: 210-196**

Aluminum carrier rail; 35 x 8.2 mm; 1.6 mm thick; 2 m long; unslotted; similar to EN 60715; silver-colored

[www.wago.com/210-196](http://www.wago.com/210-196)

### Protective warning marker

Cover



**Item no.: 2002-115**

Protective warning marker; for 5 terminal blocks; with high-voltage symbol, black; yellow

[www.wago.com/2002-115](http://www.wago.com/2002-115)

### Tool

Operating tool



**Item no.: 210-658**

Operating tool; Blade: 3.5 x 0.5 mm; with a partially insulated shaft; angled; short; multicoloured

[www.wago.com/210-658](http://www.wago.com/210-658)



**Item no.: 210-720**

Operating tool; Blade: 3.5 x 0.5 mm; with a partially insulated shaft; multicoloured

[www.wago.com/210-720](http://www.wago.com/210-720)

### Marking accessories

Marking strip



**Item no.: 2009-110**

Marking strips; for Smart Printer; on reel; not stretchable; plain; snap-on type; white

[www.wago.com/2009-110](http://www.wago.com/2009-110)

Marker carrier



**Item no.: 2009-198**

Adaptor; gray

[www.wago.com/2009-198](http://www.wago.com/2009-198)



**Item no.: 2002-121**

Adaptor; gray

[www.wago.com/2002-121](http://www.wago.com/2002-121)



**Item no.: 2002-161**

Adaptor; gray

[www.wago.com/2002-161](http://www.wago.com/2002-161)

Marker

Subject to changes. Please also observe the further product documentation!

WAGO GmbH & Co. KG

Hansastr. 27

32423 Minden

Phone: +49571 887-0 | Fax: +49571 887-169

Email: [info.de@wago.com](mailto:info.de@wago.com) | Web: [www.wago.com](http://www.wago.com)

Do you have any questions about our products?

We are always happy to take your call at +49 (571) 887-44222.

	<b>Item no.: 2009-115/000-002</b> WMB-Inline; for Smart Printer; 1500 pieces on roll; stretchable 5 - 5.2 mm; plain; snap-on type; yellow	<a href="http://www.wago.com/2009-115/000-002">www.wago.com/2009-115/000-002</a>
	<b>Item no.: 2009-115/000-007</b> WMB-Inline; for Smart Printer; 1500 pieces on roll; stretchable 5 - 5.2 mm; plain; snap-on type; gray	<a href="http://www.wago.com/2009-115/000-007">www.wago.com/2009-115/000-007</a>
	<b>Item no.: 2009-115/000-017</b> WMB-Inline; for Smart Printer; 1500 pieces on roll; stretchable 5 - 5.2 mm; plain; snap-on type; light green	<a href="http://www.wago.com/2009-115/000-017">www.wago.com/2009-115/000-017</a>
	<b>Item no.: 2009-115/000-023</b> WMB-Inline; for Smart Printer; 1500 pieces on roll; stretchable 5 - 5.2 mm; plain; snap-on type; green	<a href="http://www.wago.com/2009-115/000-023">www.wago.com/2009-115/000-023</a>
	<b>Item no.: 2009-115/000-024</b> WMB-Inline; for Smart Printer; 1500 pieces on roll; stretchable 5 - 5.2 mm; plain; snap-on type; violet	<a href="http://www.wago.com/2009-115/000-024">www.wago.com/2009-115/000-024</a>
	<b>Item no.: 2009-145/000-006</b> Mini-WSB Inline; for Smart Printer; 1700 pieces on roll; stretchable 5 - 5.2 mm; plain; snap-on type; blue	<a href="http://www.wago.com/2009-145/000-006">www.wago.com/2009-145/000-006</a>
	<b>Item no.: 2009-145</b> Mini-WSB Inline; for Smart Printer; 1700 pieces on roll; stretchable 5 - 5.2 mm; plain; snap-on type; white	<a href="http://www.wago.com/2009-145">www.wago.com/2009-145</a>
	<b>Item no.: 2009-145/000-002</b> Mini-WSB Inline; for Smart Printer; 1700 pieces on roll; stretchable 5 - 5.2 mm; plain; snap-on type; yellow	<a href="http://www.wago.com/2009-145/000-002">www.wago.com/2009-145/000-002</a>
	<b>Item no.: 2009-145/000-007</b> Mini-WSB Inline; for Smart Printer; 1700 pieces on roll; stretchable 5 - 5.2 mm; plain; snap-on type; gray	<a href="http://www.wago.com/2009-145/000-007">www.wago.com/2009-145/000-007</a>
	<b>Item no.: 2009-145/000-005</b> Mini-WSB Inline; for Smart Printer; 1700 pieces on roll; stretchable 5 - 5.2 mm; plain; snap-on type; red	<a href="http://www.wago.com/2009-145/000-005">www.wago.com/2009-145/000-005</a>
	<b>Item no.: 2009-145/000-012</b> Mini-WSB Inline; for Smart Printer; 1700 pieces on roll; stretchable 5 - 5.2 mm; plain; snap-on type; orange	<a href="http://www.wago.com/2009-145/000-012">www.wago.com/2009-145/000-012</a>
	<b>Item no.: 2009-145/000-023</b> Mini-WSB Inline; for Smart Printer; 1700 pieces on roll; stretchable 5 - 5.2 mm; plain; snap-on type; green	<a href="http://www.wago.com/2009-145/000-023">www.wago.com/2009-145/000-023</a>
	<b>Item no.: 2009-145/000-024</b> Mini-WSB Inline; for Smart Printer; 1700 pieces on roll; stretchable 5 - 5.2 mm; plain; snap-on type; violet	<a href="http://www.wago.com/2009-145/000-024">www.wago.com/2009-145/000-024</a>

Subject to changes. Please also observe the further product documentation!





**Item no.: 2009-115**

WMB-Inline; for Smart Printer; 1500 pieces on roll; stretchable 5 - 5.2 mm; plain; snap-on type; white

[www.wago.com/2009-115](http://www.wago.com/2009-115)



**Item no.: 248-501/000-006**

Mini-WSB marking card; as card; not stretchable; plain; snap-on type; blue

[www.wago.com/248-501/000-006](http://www.wago.com/248-501/000-006)



**Item no.: 248-501/000-007**

Mini-WSB marking card; as card; not stretchable; plain; snap-on type; gray

[www.wago.com/248-501/000-007](http://www.wago.com/248-501/000-007)



**Item no.: 248-501/000-002**

Mini-WSB marking card; as card; not stretchable; plain; snap-on type; yellow

[www.wago.com/248-501/000-002](http://www.wago.com/248-501/000-002)



**Item no.: 248-501/000-012**

Mini-WSB marking card; as card; not stretchable; plain; snap-on type; orange

[www.wago.com/248-501/000-012](http://www.wago.com/248-501/000-012)



**Item no.: 248-501**

Mini-WSB marking card; as card; not stretchable; plain; snap-on type; white

[www.wago.com/248-501](http://www.wago.com/248-501)



**Item no.: 248-501/000-017**

Mini-WSB marking card; as card; not stretchable; plain; snap-on type; light green

[www.wago.com/248-501/000-017](http://www.wago.com/248-501/000-017)



**Item no.: 248-501/000-005**

Mini-WSB marking card; as card; not stretchable; plain; snap-on type; red

[www.wago.com/248-501/000-005](http://www.wago.com/248-501/000-005)



**Item no.: 248-501/000-024**

Mini-WSB marking card; as card; not stretchable; plain; snap-on type; violet

[www.wago.com/248-501/000-024](http://www.wago.com/248-501/000-024)



**Item no.: 248-501/000-023**

Mini-WSB marking card; as card; not stretchable; plain; snap-on type; green

[www.wago.com/248-501/000-023](http://www.wago.com/248-501/000-023)



**Item no.: 793-5501/000-007**

WMB marking card; as card; for terminal block width 5 - 17.5 mm; stretchable 5 - 5.2 mm; plain; snap-on type; gray

[www.wago.com/793-5501/000-007](http://www.wago.com/793-5501/000-007)

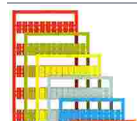

**Item no.: 793-5501/000-012**

WMB marking card; as card; for terminal block width 5 - 17.5 mm; stretchable 5 - 5.2 mm; plain; snap-on type; orange

[www.wago.com/793-5501/000-012](http://www.wago.com/793-5501/000-012)

Subject to changes. Please also observe the further product documentation!

WAGO GmbH & Co. KG

Hansastr. 27

32423 Minden

Phone: +49571 887-0 | Fax: +49571 887-169

Email: [info.de@wago.com](mailto:info.de@wago.com) | Web: [www.wago.com](http://www.wago.com)

Do you have any questions about our products?

We are always happy to take your call at +49 (571) 887-44222.



**Item no.: 793-5501/000-014**

WMB marking card; as card; for terminal block width 5 - 17.5 mm; stretchable 5 - 5.2 mm; plain; snap-on type; brown [www.wago.com/793-5501/000-014](http://www.wago.com/793-5501/000-014)



**Item no.: 793-5501/000-017**

WMB marking card; as card; for terminal block width 5 - 17.5 mm; stretchable 5 - 5.2 mm; plain; snap-on type; light green [www.wago.com/793-5501/000-017](http://www.wago.com/793-5501/000-017)



**Item no.: 793-5501/000-023**

WMB marking card; as card; for terminal block width 5 - 17.5 mm; stretchable 5 - 5.2 mm; plain; snap-on type; green [www.wago.com/793-5501/000-023](http://www.wago.com/793-5501/000-023)



**Item no.: 793-5501/000-024**

WMB marking card; as card; for terminal block width 5 - 17.5 mm; stretchable 5 - 5.2 mm; plain; snap-on type; violet [www.wago.com/793-5501/000-024](http://www.wago.com/793-5501/000-024)



**Item no.: 793-5501/000-005**

WMB marking card; as card; for terminal block width 5 - 17.5 mm; stretchable 5 - 5.2 mm; plain; snap-on type; red [www.wago.com/793-5501/000-005](http://www.wago.com/793-5501/000-005)



**Item no.: 793-5501/000-002**

WMB marking card; as card; for terminal block width 5 - 17.5 mm; stretchable 5 - 5.2 mm; plain; snap-on type; yellow [www.wago.com/793-5501/000-002](http://www.wago.com/793-5501/000-002)



**Item no.: 793-5501/000-006**

WMB marking card; as card; for terminal block width 5 - 17.5 mm; stretchable 5 - 5.2 mm; plain; snap-on type; blue [www.wago.com/793-5501/000-006](http://www.wago.com/793-5501/000-006)



**Item no.: 793-5501**

WMB marking card; as card; for terminal block width 5 - 17.5 mm; stretchable 5 - 5.2 mm; plain; snap-on type; white [www.wago.com/793-5501](http://www.wago.com/793-5501)



**Item no.: 2009-115/000-012**

WMB-Inline; for Smart Printer; 1500 pieces on roll; stretchable 5 - 5.2 mm; plain; snap-on type; orange [www.wago.com/2009-115/000-012](http://www.wago.com/2009-115/000-012)



**Item no.: 2009-115/000-006**

WMB-Inline; for Smart Printer; 1500 pieces on roll; stretchable 5 - 5.2 mm; plain; snap-on type; blue [www.wago.com/2009-115/000-006](http://www.wago.com/2009-115/000-006)



**Item no.: 2009-115/000-005**

WMB-Inline; for Smart Printer; 1500 pieces on roll; stretchable 5 - 5.2 mm; plain; snap-on type; red [www.wago.com/2009-115/000-005](http://www.wago.com/2009-115/000-005)

Group marker carrier



**Item no.: 2009-193**

[www.wago.com/2009-193](http://www.wago.com/2009-193)

Subject to changes. Please also observe the further product documentation!

Group marker carrier; gray

**Item no.: 2009-192**

Group marker carrier; gray

[www.wago.com/2009-192](http://www.wago.com/2009-192)**Item no.: 2009-191**

Group marker carrier; gray

[www.wago.com/2009-191](http://www.wago.com/2009-191)

### Jumpers

#### Jumper

**Item no.: 210-123**

Wire commoning chain; insulated; blue

[www.wago.com/210-123](http://www.wago.com/210-123)**Item no.: 2002-402**

Jumper; 2-way; insulated; light gray

[www.wago.com/2002-402](http://www.wago.com/2002-402)**Item no.: 2002-402/000-005**

Jumper; 2-way; insulated; red

[www.wago.com/2002-402/000-005](http://www.wago.com/2002-402/000-005)**Item no.: 2002-400**

Continuous jumper; 2-way; insulated; light gray

[www.wago.com/2002-400](http://www.wago.com/2002-400)**Item no.: 2002-403**

Jumper; 3-way; insulated; light gray

[www.wago.com/2002-403](http://www.wago.com/2002-403)**Item no.: 2002-404/000-005**

Jumper; 4-way; insulated; red

[www.wago.com/2002-404/000-005](http://www.wago.com/2002-404/000-005)**Item no.: 2002-403/000-006**

Jumper; 3-way; insulated; blue

[www.wago.com/2002-403/000-006](http://www.wago.com/2002-403/000-006)**Item no.: 2002-404/000-006**

Jumper; 4-way; insulated; blue

[www.wago.com/2002-404/000-006](http://www.wago.com/2002-404/000-006)**Item no.: 2002-403/000-005**

Jumper; 3-way; insulated; red

[www.wago.com/2002-403/000-005](http://www.wago.com/2002-403/000-005)**Item no.: 2002-405/000-005**

Jumper; 5-way; insulated; red

[www.wago.com/2002-405/000-005](http://www.wago.com/2002-405/000-005)**Item no.: 2002-402/000-006**

Jumper; 2-way; insulated; blue

[www.wago.com/2002-402/000-006](http://www.wago.com/2002-402/000-006)

Subject to changes. Please also observe the further product documentation!

WAGO GmbH &amp; Co. KG

Hansastr. 27

32423 Minden

Phone: +49571 887-0 | Fax: +49571 887-169

Email: [info.de@wago.com](mailto:info.de@wago.com) | Web: [www.wago.com](http://www.wago.com)

Do you have any questions about our products?

We are always happy to take your call at +49 (571) 887-44222.



**Item no.: 2002-405/000-006**  
Jumper; 5-way; insulated; blue

[www.wago.com/2002-405/000-006](http://www.wago.com/2002-405/000-006)



**Item no.: 2002-404**  
Jumper; 4-way; insulated; light gray

[www.wago.com/2002-404](http://www.wago.com/2002-404)



**Item no.: 2002-406/000-006**  
Jumper; 6-way; insulated; blue

[www.wago.com/2002-406/000-006](http://www.wago.com/2002-406/000-006)



**Item no.: 2002-406/000-005**  
Jumper; 6-way; insulated; red

[www.wago.com/2002-406/000-005](http://www.wago.com/2002-406/000-005)



**Item no.: 2002-406/020-000**  
Delta jumper; insulated; light gray

[www.wago.com/2002-406/020-000](http://www.wago.com/2002-406/020-000)



**Item no.: 2002-405**  
Jumper; 5-way; insulated; light gray

[www.wago.com/2002-405](http://www.wago.com/2002-405)



**Item no.: 2002-407/000-005**  
Jumper; 7-way; insulated; red

[www.wago.com/2002-407/000-005](http://www.wago.com/2002-407/000-005)



**Item no.: 2002-408**  
Jumper; 8-way; insulated; light gray

[www.wago.com/2002-408](http://www.wago.com/2002-408)



**Item no.: 2002-408/000-006**  
Jumper; 8-way; insulated; blue

[www.wago.com/2002-408/000-006](http://www.wago.com/2002-408/000-006)



**Item no.: 2002-405/011-000**  
Star point jumper; 3-way; insulated; light gray

[www.wago.com/2002-405/011-000](http://www.wago.com/2002-405/011-000)



**Item no.: 2002-407/000-006**  
Jumper; 7-way; insulated; blue















[www.wago.com/2002-407/000-006](http://www.wago.com/2002-407/000-006)



















**Item no.: 2002-408/000-005**  
Jumper; 8-way; insulated; red

[www.wago.com/2002-408/000-005](http://www.wago.com/2002-408/000-005)















Subject to changes. Please also observe the further product documentation!

	<b>Item no.: 2002-407</b> Jumper; 7-way; insulated; light gray	<a href="http://www.wago.com/2002-407">www.wago.com/2002-407</a>
	<b>Item no.: 2002-406</b> Jumper; 6-way; insulated; light gray	<a href="http://www.wago.com/2002-406">www.wago.com/2002-406</a>
	<b>Item no.: 2002-410/000-005</b> Jumper; 10-way; insulated; red	<a href="http://www.wago.com/2002-410/000-005">www.wago.com/2002-410/000-005</a>
	<b>Item no.: 2002-410/000-006</b> Jumper; 10-way; insulated; blue	<a href="http://www.wago.com/2002-410/000-006">www.wago.com/2002-410/000-006</a>
	<b>Item no.: 2002-410</b> Jumper; 10-way; insulated; light gray	<a href="http://www.wago.com/2002-410">www.wago.com/2002-410</a>
	<b>Item no.: 2002-409/000-006</b> Jumper; 9-way; insulated; blue	<a href="http://www.wago.com/2002-409/000-006">www.wago.com/2002-409/000-006</a>
	<b>Item no.: 2002-409/000-005</b> Jumper; 9-way; insulated; red	<a href="http://www.wago.com/2002-409/000-005">www.wago.com/2002-409/000-005</a>
	<b>Item no.: 2002-409</b> Jumper; 9-way; insulated; light gray	<a href="http://www.wago.com/2002-409">www.wago.com/2002-409</a>
	<b>Item no.: 2002-423/000-006</b> Continuous jumper; from 1 to 3; insulated; blue	<a href="http://www.wago.com/2002-423/000-006">www.wago.com/2002-423/000-006</a>
	<b>Item no.: 2002-423</b> Continuous jumper; from 1 to 3; insulated; light gray	<a href="http://www.wago.com/2002-423">www.wago.com/2002-423</a>
	<b>Item no.: 2002-433</b> Jumper; from 1 to 3; insulated; light gray	<a href="http://www.wago.com/2002-433">www.wago.com/2002-433</a>
	<b>Item no.: 2002-434</b> Jumper; from 1 to 4; insulated; light gray	<a href="http://www.wago.com/2002-434">www.wago.com/2002-434</a>
	<b>Item no.: 2002-423/000-005</b> Continuous jumper; from 1 to 3; insulated; red	<a href="http://www.wago.com/2002-423/000-005">www.wago.com/2002-423/000-005</a>
	<b>Item no.: 2002-435</b>	<a href="http://www.wago.com/2002-435">www.wago.com/2002-435</a>









Subject to changes. Please also observe the further product documentation!

	Jumper; from 1 to 5; insulated; light gray	
	<b>Item no.: 2002-436</b> Jumper; from 1 to 6; insulated; light gray	<a href="http://www.wago.com/2002-436">www.wago.com/2002-436</a>
	<b>Item no.: 2002-437</b> Jumper; from 1 to 7; insulated; light gray	<a href="http://www.wago.com/2002-437">www.wago.com/2002-437</a>
	<b>Item no.: 2002-438</b> Jumper; from 1 to 8; insulated; light gray	<a href="http://www.wago.com/2002-438">www.wago.com/2002-438</a>
	<b>Item no.: 2002-439</b> Jumper; from 1 to 9; insulated; light gray	<a href="http://www.wago.com/2002-439">www.wago.com/2002-439</a>
	<b>Item no.: 2002-440</b> Jumper; from 1 to 10; insulated; light gray	<a href="http://www.wago.com/2002-440">www.wago.com/2002-440</a>
	<b>Item no.: 2002-472</b> Staggered jumper; 2-way; insulated; light gray	<a href="http://www.wago.com/2002-472">www.wago.com/2002-472</a>
	<b>Item no.: 2002-473</b> Staggered jumper; 3-way; insulated; light gray	<a href="http://www.wago.com/2002-473">www.wago.com/2002-473</a>
	<b>Item no.: 2002-475/011-000</b> Staggered jumper; 3-way; insulated; light gray	<a href="http://www.wago.com/2002-475/011-000">www.wago.com/2002-475/011-000</a>
	<b>Item no.: 2002-475</b> Staggered jumper; 5-way; insulated; light gray	<a href="http://www.wago.com/2002-475">www.wago.com/2002-475</a>
	<b>Item no.: 2002-476</b> Staggered jumper; 6-way; insulated; light gray	<a href="http://www.wago.com/2002-476">www.wago.com/2002-476</a>
	<b>Item no.: 2002-474</b> Staggered jumper; 4-way; insulated; light gray	<a href="http://www.wago.com/2002-474">www.wago.com/2002-474</a>
	<b>Item no.: 2002-477</b> Staggered jumper; 7-way; insulated; light gray	<a href="http://www.wago.com/2002-477">www.wago.com/2002-477</a>
	<b>Item no.: 2002-473/011-000</b> Staggered jumper; 2-way; from 1 to 3; insulated; light gray	<a href="http://www.wago.com/2002-473/011-000">www.wago.com/2002-473/011-000</a>
	<b>Item no.: 2002-479</b> Staggered jumper; 9-way; insulated; light gray	<a href="http://www.wago.com/2002-479">www.wago.com/2002-479</a>
	<b>Item no.: 2002-478</b> Staggered jumper; 8-way; insulated; light gray	<a href="http://www.wago.com/2002-478">www.wago.com/2002-478</a>
	<b>Item no.: 2002-479/011-000</b> Staggered jumper; insulated; light gray	<a href="http://www.wago.com/2002-479/011-000">www.wago.com/2002-479/011-000</a>





Subject to changes. Please also observe the further product documentation!

	<b>Item no.: 2002-480</b> Staggered jumper; 10-way; insulated; light gray	<a href="http://www.wago.com/2002-480">www.wago.com/2002-480</a>
	<b>Item no.: 2002-477/011-000</b> Staggered jumper; insulated; light gray	<a href="http://www.wago.com/2002-477/011-000">www.wago.com/2002-477/011-000</a>
	<b>Item no.: 2002-481/011-000</b> Staggered jumper; insulated; light gray	<a href="http://www.wago.com/2002-481/011-000">www.wago.com/2002-481/011-000</a>
	<b>Item no.: 2002-481</b> Staggered jumper; 11-way; insulated; light gray	<a href="http://www.wago.com/2002-481">www.wago.com/2002-481</a>
	<b>Item no.: 2002-482</b> Staggered jumper; 12-way; insulated; light gray	<a href="http://www.wago.com/2002-482">www.wago.com/2002-482</a>
	<b>Item no.: 210-103</b> Wire commoning chain; insulated; black	<a href="http://www.wago.com/210-103">www.wago.com/210-103</a>
	<b>Item no.: 2002-424/000-006</b> Continuous jumper; from 1 to 4; insulated; blue	<a href="http://www.wago.com/2002-424/000-006">www.wago.com/2002-424/000-006</a>
<b>Testing and measuring</b>		
Testing accessories		
	<b>Item no.: 2009-174</b> Test plug adapter; for 4 mm Ø test plugs; for testing TOPJOB®S rail-mounted terminal blocks; gray	<a href="http://www.wago.com/2009-174">www.wago.com/2009-174</a>
	<b>Item no.: 2009-182</b> Testing tap; for max. 2.5 mm <sup>2</sup> ; tool-free connection for individual test wires 0.08 - 2.5 mm; gray	<a href="http://www.wago.com/2009-182">www.wago.com/2009-182</a>
	<b>Item no.: 2002-511</b> Modular TOPJOB®S connector; modular; for jumper contact slot; 1-pole; 2,50 mm <sup>2</sup> ; gray	<a href="http://www.wago.com/2002-511">www.wago.com/2002-511</a>
	<b>Item no.: 2002-549</b> Spacer module; modular; e.g., for bridging commoned terminal blocks; gray	<a href="http://www.wago.com/2002-549">www.wago.com/2002-549</a>
	<b>Item no.: 2002-552</b> Modular TOPJOB®S connector; modular; for jumper contact slot; 2-pole; 2,50 mm <sup>2</sup> ; gray	<a href="http://www.wago.com/2002-552">www.wago.com/2002-552</a>
	<b>Item no.: 2002-558</b> Modular TOPJOB®S connector; modular; for jumper contact slot; 8-pole; 2,50 mm <sup>2</sup> ; gray	<a href="http://www.wago.com/2002-558">www.wago.com/2002-558</a>
	<b>Item no.: 2002-559</b> Modular TOPJOB®S connector; modular; for jumper contact slot; 9-pole; 2,50 mm <sup>2</sup> ; gray	<a href="http://www.wago.com/2002-559">www.wago.com/2002-559</a>
	<b>Item no.: 2002-556</b> Modular TOPJOB®S connector; modular; for jumper contact slot; 6-pole; 2,50 mm <sup>2</sup> ; gray	<a href="http://www.wago.com/2002-556">www.wago.com/2002-556</a>

Subject to changes. Please also observe the further product documentation!

	<b>Item no.: 2002-553</b> Modular TOPJOB®S connector; modular; for jumper contact slot; 3-pole; 2,50 mm <sup>2</sup> ; gray	<a href="http://www.wago.com/2002-553">www.wago.com/2002-553</a>
	<b>Item no.: 2002-611</b> TOPJOB®S L-type test plug module; modular; 1-pole; 2,50 mm <sup>2</sup> ; gray	<a href="http://www.wago.com/2002-611">www.wago.com/2002-611</a>
	<b>Item no.: 2002-560</b> Modular TOPJOB®S connector; modular; for jumper contact slot; 10-pole; 2,50 mm <sup>2</sup> ; gray	<a href="http://www.wago.com/2002-560">www.wago.com/2002-560</a>
	<b>Item no.: 2002-554</b> Modular TOPJOB®S connector; modular; for jumper contact slot; 4-pole; 2,50 mm <sup>2</sup> ; gray	<a href="http://www.wago.com/2002-554">www.wago.com/2002-554</a>
	<b>Item no.: 2002-555</b> Modular TOPJOB®S connector; modular; for jumper contact slot; 5-pole; 2,50 mm <sup>2</sup> ; gray	<a href="http://www.wago.com/2002-555">www.wago.com/2002-555</a>
	<b>Item no.: 2002-557</b> Modular TOPJOB®S connector; modular; for jumper contact slot; 7-pole; 2,50 mm <sup>2</sup> ; gray	<a href="http://www.wago.com/2002-557">www.wago.com/2002-557</a>
	<b>Item no.: 2002-649</b> TOPJOB®S L-type spacer module; modular; e.g., for bridging commoned terminal blocks; gray	<a href="http://www.wago.com/2002-649">www.wago.com/2002-649</a>
	<b>Item no.: 210-136</b> Test plug; 2 mm Ø; with 500 mm cable; red	<a href="http://www.wago.com/210-136">www.wago.com/210-136</a>

**Push-in type wire jumper**

Jumper		
	<b>Item no.: 2009-412</b> Push-in type wire jumper; insulated; 60 mm long; black	<a href="http://www.wago.com/2009-412">www.wago.com/2009-412</a>
	<b>Item no.: 2009-414</b> Push-in type wire jumper; 1.5 mm <sup>2</sup> ; insulated; 110 mm long; black	<a href="http://www.wago.com/2009-414">www.wago.com/2009-414</a>
	<b>Item no.: 2009-416</b> Push-in type wire jumper; 1.5 mm <sup>2</sup> ; insulated; 250 mm long; black	<a href="http://www.wago.com/2009-416">www.wago.com/2009-416</a>
	<b>Item no.: 2009-414/000-005</b> Push-in type wire jumper; 1.5 mm <sup>2</sup> ; insulated; 110 mm long; black	<a href="http://www.wago.com/2009-414/000-005">www.wago.com/2009-414/000-005</a>
	<b>Item no.: 2009-414/000-006</b> Push-in type wire jumper; insulated; 110 mm long; black	<a href="http://www.wago.com/2009-414/000-006">www.wago.com/2009-414/000-006</a>

**Mounting**

Cover carrier		
	<b>Item no.: 709-169</b> Cover carrier; Type 3; gray	<a href="http://www.wago.com/709-169">www.wago.com/709-169</a>
Cover		

Subject to changes. Please also observe the further product documentation!





Item no.: 709-156

Cover; Type 3; suitable for cover carrier, type 3; 1 m long; transparent

## Downloads

### Documentation

#### Bid Text

2002-1707 X81 - Datei	2019 May 20	xml 4.0 kB	Download
--------------------------	-------------	---------------	----------

2002-1707 docx - Datei	2019 Apr 23	docx 15.7 kB	Download
---------------------------	-------------	-----------------	----------

#### Additional Information

Technical Section Technical explanations		pdf 2.2 MB	Download
---	--	---------------	----------

## CAD/CAE-Data

### CAE data

EPLAN Data Portal 2002-1707		URL	Download
-----------------------------	--	-----	----------

ZUKEN Portal 2002-1707		URL	Download
------------------------	--	-----	----------

WSCAD Universe 2002-1707		URL	Download
--------------------------	--	-----	----------

### CAD data

2D/3D Models 2002-1707		URL	Download
------------------------	--	-----	----------

## Environmental Product Compliance

### Compliance Search

Environmental Product Compliance 2002-1707		URL	Download
--	--	-----	----------

3-conductor ground terminal block; 2.5 mm<sup>2</sup>; side and center marking; for DIN-rail 35 x 15 and 35 x 7.5; Push-in CAGE CLAMP®; 2,50 mm<sup>2</sup>; green-yellow

Subject to changes. Please also observe the further product documentation!

## Installation Notes

### Conductor termination

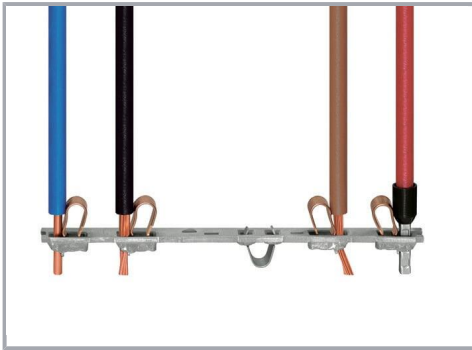

All conductor types at a glance

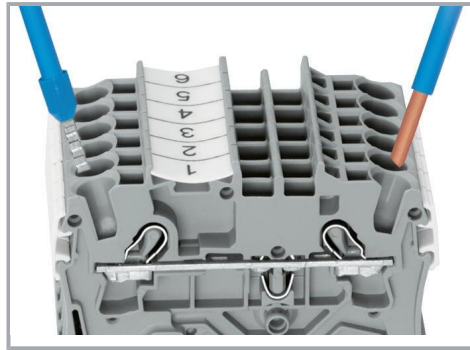

Push-in termination of solid and ferruled conductors

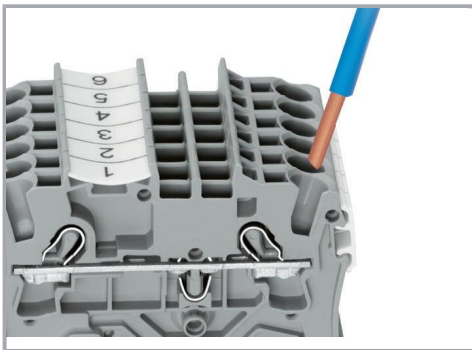

Inserting a conductor via push-in termination:

Solid conductors with cross-sections from either one size above, or up to two sizes below, the rated cross-section can be simply pushed in – no tools needed.

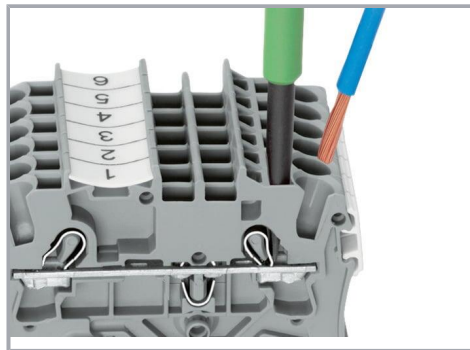

Inserting a conductor via operating tool:

Connecting fine-stranded conductors without ferrules, or small cross-sectional conductors that cannot be pushed in, is performed similarly to the original CAGE CLAMP® – just use an operating tool.

#### Advantage:

To open the clamp, the operating tool is inserted vertically. The conductor entry is less than 15 degrees for easier wiring.

Subject to changes. Please also observe the further product documentation!

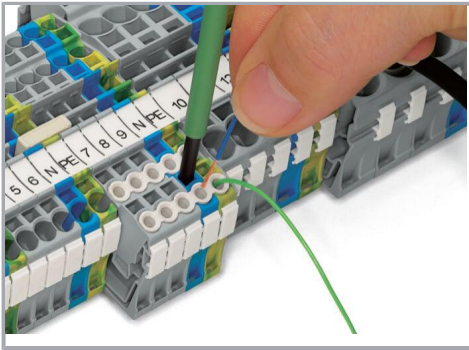

Conductor termination – insulation stop

### Commoning

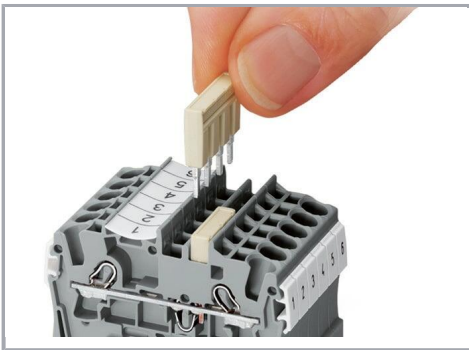

Insert push-in type jumper bar and push down until it hits backstop.

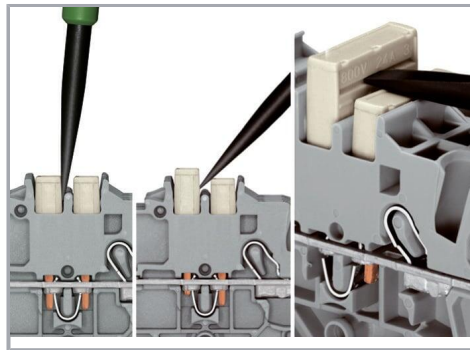

### Removing a push-in type jumper bar:

Insert the operating tool between the jumper and partition wall of the dual jumper slots, then lift up the jumper.

Place the operating tool in the center of jumpers for up to five contacts (see above), or alternately on both sides for jumpers with more than five contacts.

### Commoning

Subject to changes. Please also observe the further product documentation!

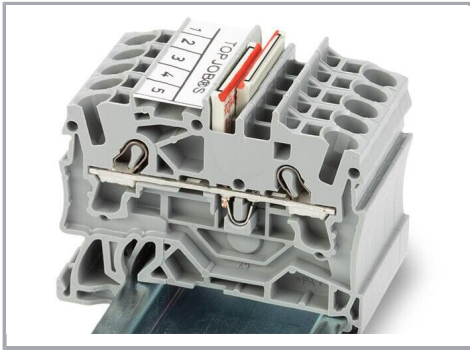

Orient the staggered jumpers' red stripes on the inside.

Insert the staggered jumper and push down until it hits the backstop.

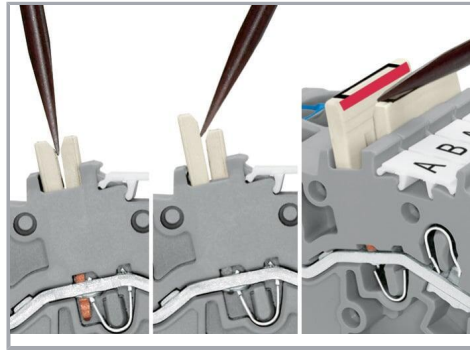

#### Removing a staggered jumper:

Insert the operating tool between the staggered jumpers, then lift up the jumper.

#### Commoning

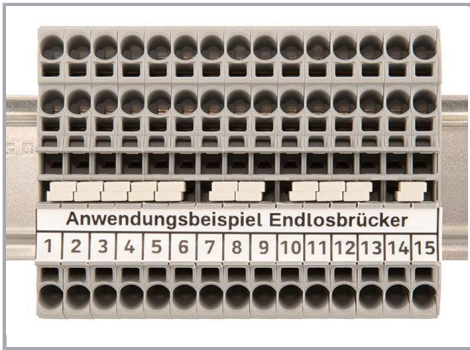

Continuous jumpers (2002 Series) readily connect an endless number of terminal blocks to each other via single jumper slot. Use the second jumper slot for additional commoning or testing.

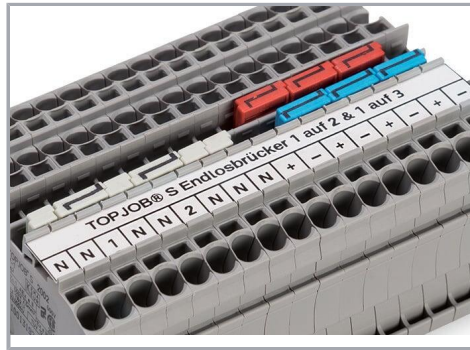

The 1-to-3 adjacent jumper for continuous commoning enables every other terminal block to be commoned. For example, positive and negative potentials can be accommodated alongside each other.

Subject to changes. Please also observe the further product documentation!

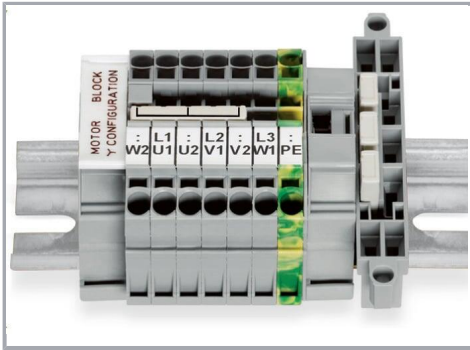

This star point jumper has been specially developed to create a "star point" and is used on motor terminal boards equipped with Rail-Mount Terminal Blocks TOPJOB® S.

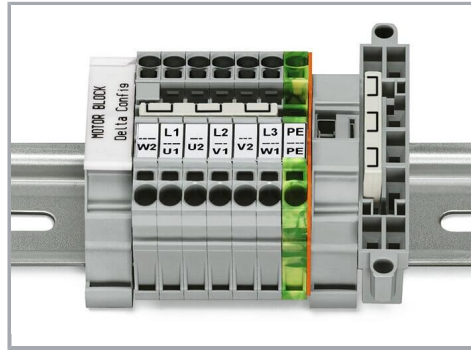

This delta jumper has been specially developed to create a delta configuration and is used on motor terminal boards equipped with rail-mount terminal blocks TOPJOB® S.

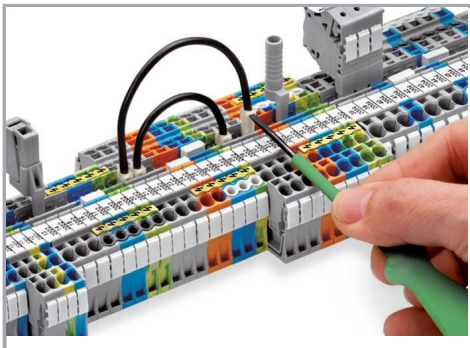

Push down the wire jumper until fully inserted. Lift the jumper with an operating tool for rewiring.

## Testing

Subject to changes. Please also observe the further product documentation!

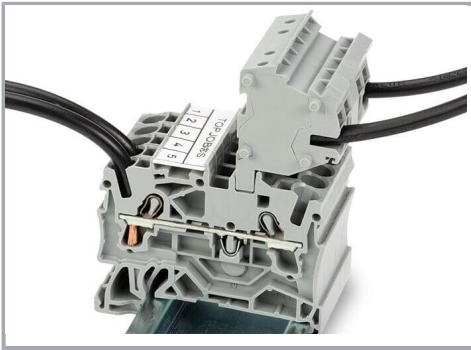

The modular TOPJOB® S connectors also connect conductors of the same size as the terminal blocks being used.

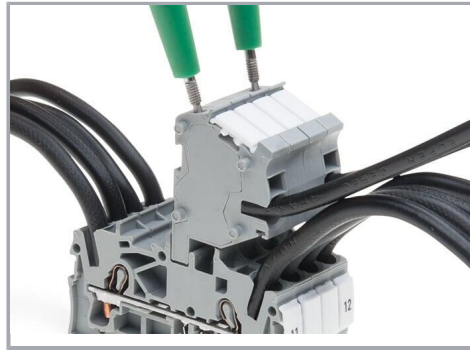

TOPJOB® S Connectors with a 2 mm Ø test socket for testing voltage via 2-pole voltage tester

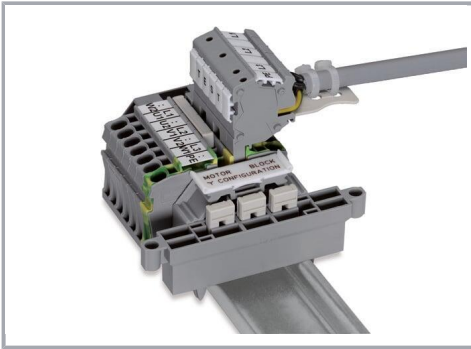

Rail-mount terminal block assembly for electric motor wiring

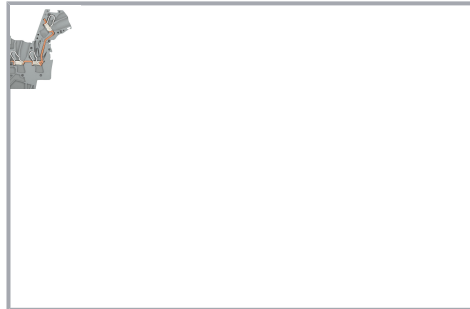

L-type test plug module – cross-sectional view of contacts

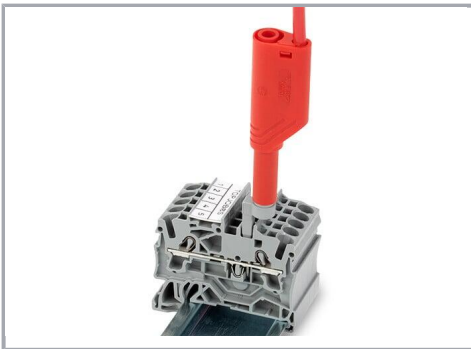

Test plug adapter (2009-174, CAT I) for 4 mm Ø plugs – compatible with 2000 to 2016 Series

Subject to changes. Please also observe the further product documentation!

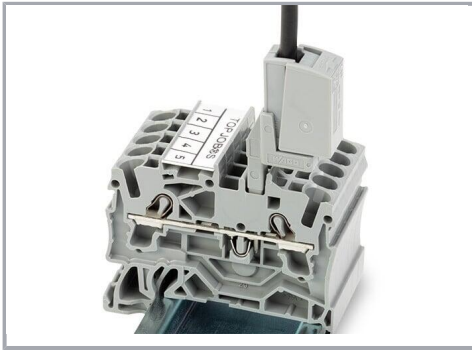

Testing tap (2009-182) for tool-free connection of test cables up to 2.5 mm<sup>2</sup> (12 AWG) – compatible with 2000 to 2016 Series

### Marking

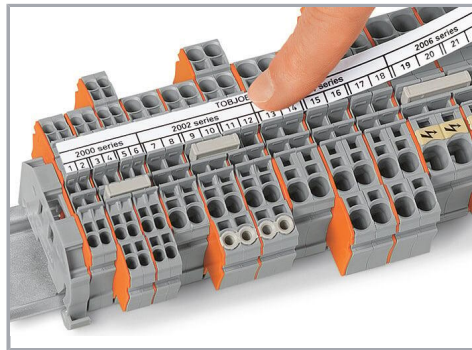
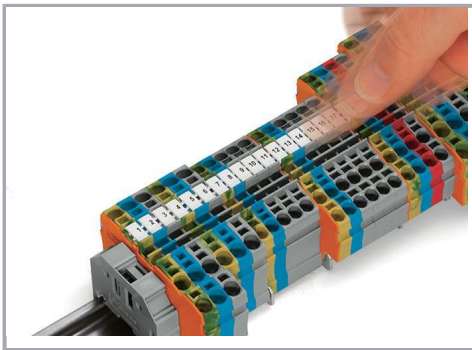

Snapping WMB Inline markers into marker slots.

Subject to changes. Please also observe the further product documentation!

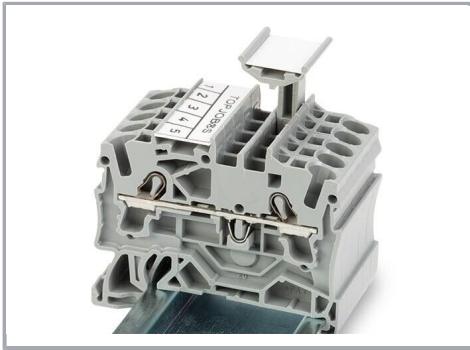

TOPJOB® S 2009-193 Group Marker Carrier (equipped with a marking strip) for all 2001 to 2016 Series TOPJOB® S Rail-Mount Terminal Blocks

Do not use on an end plate!

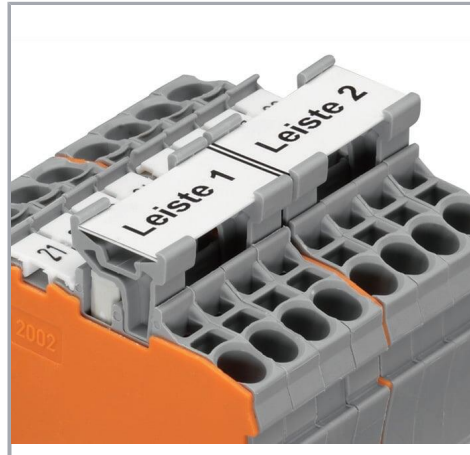

Using marker carriers for marking strips (2002-161) in jumper slots.

## Product family

### TOPJOB® S

TOPJOB® S: In various industrial applications and modern building installations, WAGO's wide and versatile range of rail-mount terminal blocks provides more than just reliable electrical connections.

[Show all products from the family](#)

Subject to changes. Please also observe the further product documentation!