



## ANT-LTE-MON-SMA-E

### LTE Cellular and GPS/GNSS Connectorized Monopole Whip Antenna

The MON-E antenna is a member of Linx's LTE-MON family of compact rotatable hinged-whip antennas which offer optimized support for a wide range of LTE cellular, LPWA and IoT applications.

The MON-E antenna provides excellent multiband cellular and cellular IoT performance, providing outstanding gain in the 700 MHz to 800 MHz LTE bands such as LTE 8, 12, 13, 14, 17 and 20 and including LoRaWAN® bands at 868 MHz and 915 MHz. The MON-E may also be used for GPS/GNSS applications alone or with other frequency bands.

The hinged design allows for the antenna to be positioned for optimum performance and reduces the potential for damage from impact compared to a fixed whip design.

#### FEATURES

- Optimized for 698 MHz to 960 MHz LTE with GPS/GNSS and Bluetooth® support
- Enhanced low-band coverage including LTE 5, 8, 12, 13, 14, 17, 20, and 28
  - Efficiency: 83%
  - VSWR:  $\leq 2.2$
  - Peak Gain: 4.5 dBi
- Covers all common LTE/4G/3G/2G bands
- Hinged for optimum positioning
- Small, unobtrusive profile, 71.0 mm long
- Extended temperature range to 130 °C
- SMA plug (male pin)

#### APPLICATIONS

- Cellular IoT: LTE-M (Cat-M1) and NB-IoT
  - AT&T: bands 12, 14, 17
  - Verizon: band 13
  - Europe: bands 8, 20
  - Latin America: bands 5, 28
  - Asia Pacific: bands 5, 8, 20, 28
- Worldwide LTE and GSM (4G, 3G, 2G)
- Low-power, wide-area (LPWA) applications
  - LoRaWAN®
  - Sigfox®
- Global Navigation (GNSS)
  - GPS, Galileo, BeiDou
- ISM: Bluetooth® and ZigBee®
- FirstNet® Public Safety
- Internet of Things (IoT) devices
- Gateways

#### ORDERING INFORMATION

Part Number	Description
ANT-LTE-MON-SMA-E	Antenna with SMA plug (male pin)

Available from Linx Technologies and select distributors and representatives.

## ELECTRICAL SPECIFICATIONS

Select Bands	Frequency Range	VSWR (max.)	Peak Gain (dBi)	Avg. Gain (dBi)	Efficiency (%)
LTE 71	617 MHz to 698 MHz	6.8	2.5	-2.8	58
LTE 12, 13, 14, 17, 26, 28, 29	698 MHz to 803 MHz	2.2	4.5	-1.1	83
LTE 5, 8, 20	791 MHz to 960 MHz	1.9	5.1	-0.7	83
LTE 1, 2, 3, 4, 25, 66	1710 MHz to 2200 MHz	3.2	3.3	-2.0	69
LTE 30, 40	2300 MHz to 2400 MHz	1.3	3.1	-1.2	78
LTE 7, 41	2496 MHz to 2690 MHz	2.9	1.3	-3.3	51
LTE 22, 42, 52, 43, 48, 49	3300 MHz to 3800 MHz	6.3	1.2	-5.3	30
GPS/GNSS	1553 MHz to 1609 MHz	3.6	1.1	-4.6	39
ISM	2400 MHz to 2485 MHz	1.8	2.4	-2.3	63
Polarization	Linear				
Radiation	Omnidirectional				
Max Power	10 W				
Wavelength	1/4-wave				
Electrical Type	Monopole				
Impedance	50 $\Omega$				
Connection	SMA plug (male pin)				
Weight	8.4 g (0.30 oz)				
Dimensions	71.0 mm (2.80 in)				
Operating Temperature Range	-40 °C to +130 °C				

Electrical specifications and plots measured with a 102 mm x 102 mm (4.0 in x 4.0 in) reference ground plane, edge straight orientation.

## PRODUCT DIMENSIONS

Figure 1 provides dimensions of the MON-E antenna. The antenna whip can be tilted 180 degrees, and has detents every 45 degrees enabling the antenna to be oriented in any direction. The rotating base allows for continuous positioning through 360 degrees even while installed.

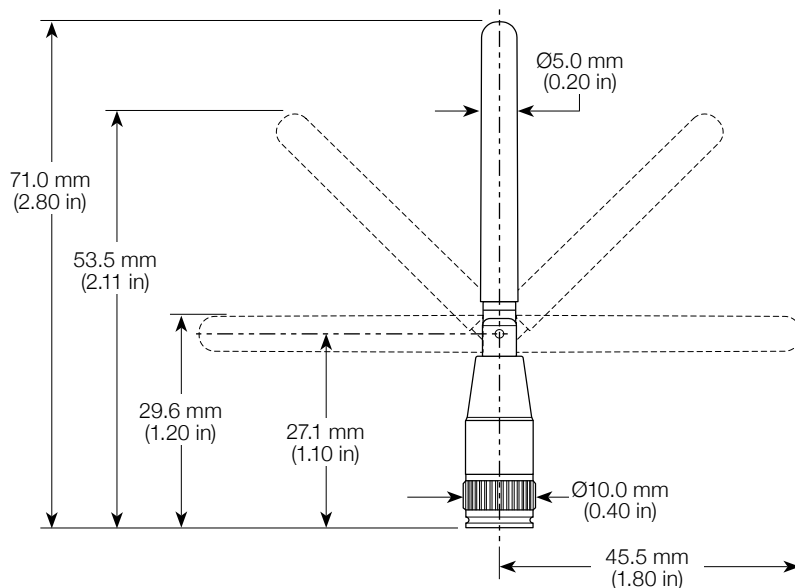

Figure 1: LTE-MON-SMA-E Antenna Dimensions

## NON-CELLULAR APPLICATIONS

The MON-E has strong performance in several application spaces apart from cellular frequency bands. These include global navigation satellite systems (GNSS), low-power wide-area (LPWA) networks and industrial, scientific and medical (ISM) unlicensed band applications. The MON-E may be used for any of these applications rather than a cellular application. The ability to use the MON-E for such a wide variety of applications makes it an excellent choice for platform-level antenna selection and economies of scale in purchasing.

Additionally, with proper design consideration, the MON-E may serve as an antenna for a cellular application and one or more non-cellular applications. If the design has separate antenna inputs for the cellular and non-cellular radios, the antenna frequencies must be split through a diplexer and maintain proper isolation between the cellular and non-cellular radio's path. If the design has a common antenna input for cellular and non-cellular applications then no added circuitry is required. Contact Linx Technologies for a complimentary design consultation.

## GPS/GNSS

The MON-E has strong performance in the frequency bands that cover GPS and more generally GNSS including Galileo, and BeiDou, Collectively, these applications span 1553.10 MHz to 1608.68 MHz. The MON-E is omnidirectional and therefore supports applications that cannot depend on a fixed orientation to the sky. The MON-E antenna is also passive, not requiring a power supply to support GPS/GNSS reception.

## LPWA: LORAWAN® AND SIGFOX®

LoRaWAN and Sigfox LPWA technologies operate within several of the frequencies supported by the MON-E. Notably, LoRaWAN operates at the frequency bands shown in Table 1. Sigfox operates at different frequencies determined by country (Table 2).

Frequency Band	LoRaWAN Channel Plan
779 MHz to 787 MHz	CN779-787
865 MHz to 867 MHz	IN765-867
868 MHz to 873 MHz	EU863-870
902 MHz to 928 MHz	US902-928, AS923
915 MHz to 928 MHz	AU915-928
917 MHz to 923.5 MHz	KR920-923

Table 1: LoRaWAN® Channel plan

Center Frequency	Select Countries/Regions
868 MHz	Europe
902 MHz	USA, Mexico, Brazil
920 MHz	Australia
923 MHz	Japan

Table 2: Sigfox® Frequencies by Country/Region

## BLUETOOTH® AND ZIGBEE®

ISM band applications for Bluetooth® or ZigBee® are centered at 2450 MHz which exhibits very good VSWR, gain and efficiency on the MON-E antenna.

---

## GROUND PLANE

1/4-Wave monopole antennas require an associated ground plane counterpoise for proper operation. The size and location of the ground plane relative to the antenna will affect the overall performance of the antenna in the final design. When used in conjunction with a ground plane smaller than that used to tune the antenna, the center frequency typically will shift higher in frequency and the bandwidth will decrease. The proximity of other circuit elements and packaging near the antenna will also affect the final performance.

For further discussion and guidance on the importance of the ground plane counterpoise, please refer to Linx Application Note, *AN-00501: Understanding Antenna Specifications and Operation*.

## ANTENNA ORIENTATION

The MON-E antenna is characterized in two antenna orientations on a 102 mm x 102 mm ground plane as shown in Figure 2. The two orientations with the antenna straight and bent 90 degrees, represent the most common orientations in end-product use.

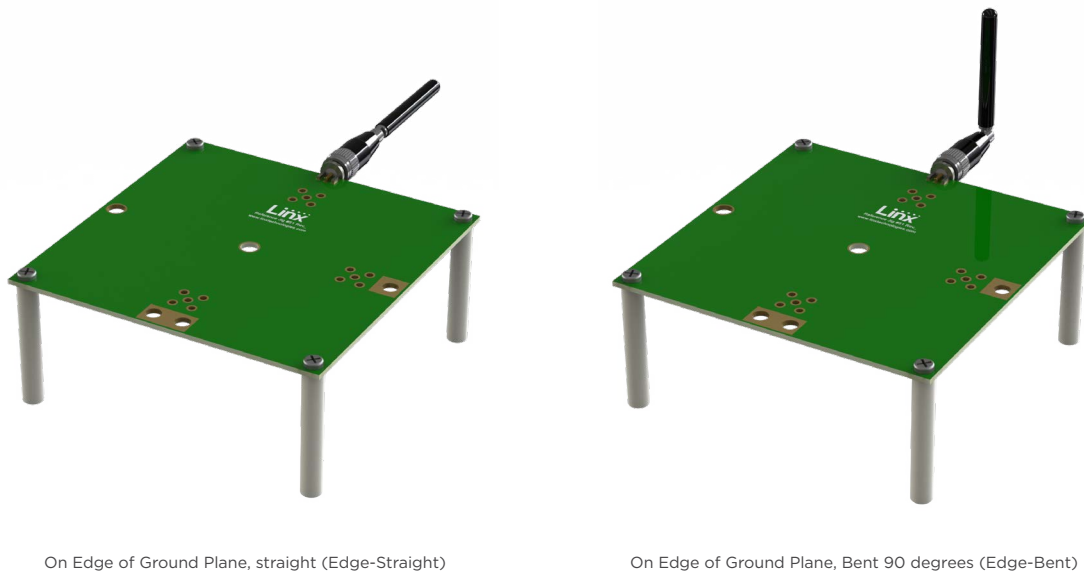

Figure 2: ANT-LTE-MON-SMA-E on Evaluation PCB

## EDGE OF GROUND PLANE, STRAIGHT

The charts on the following pages represent data taken with the antenna oriented at the edge of the ground plane, straight (Edge-Straight), as shown in Figure 3.

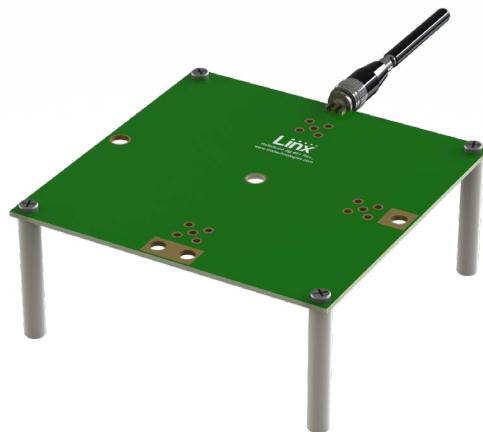

Figure 3: LTE-MON-SMA-E Shown on Edge of Ground Plane, Straight (Edge-Straight)

## VSWR

Figure 4 provides the voltage standing wave ratio (VSWR) across the antenna bandwidth. VSWR describes the power reflected from the antenna back to the radio. A lower VSWR value indicates better antenna performance at a given frequency. Reflected power is also shown on the right-side vertical axis as a gauge of the percentage of transmitter power reflected back from the antenna.

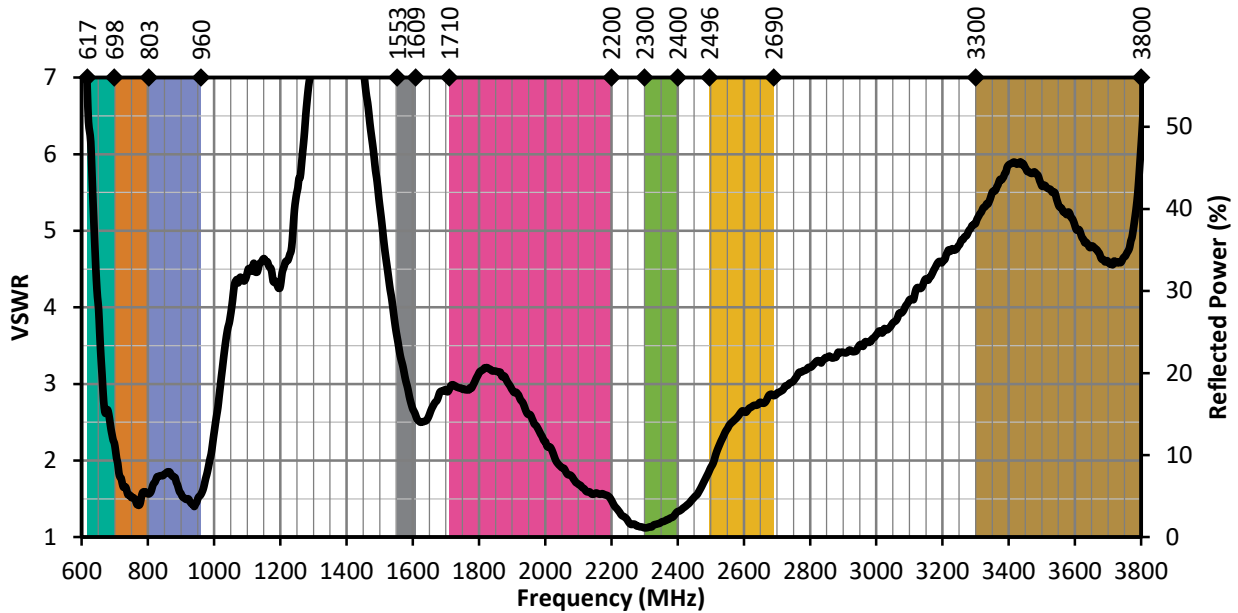

Figure 4: MON-E VSWR, Edge-Straight, with Frequency Band Highlights

## RETURN LOSS

Return loss (Figure 5), represents the loss in power at the antenna due to reflected signals. Like VSWR, a lower return loss value indicates better antenna performance at a given frequency.

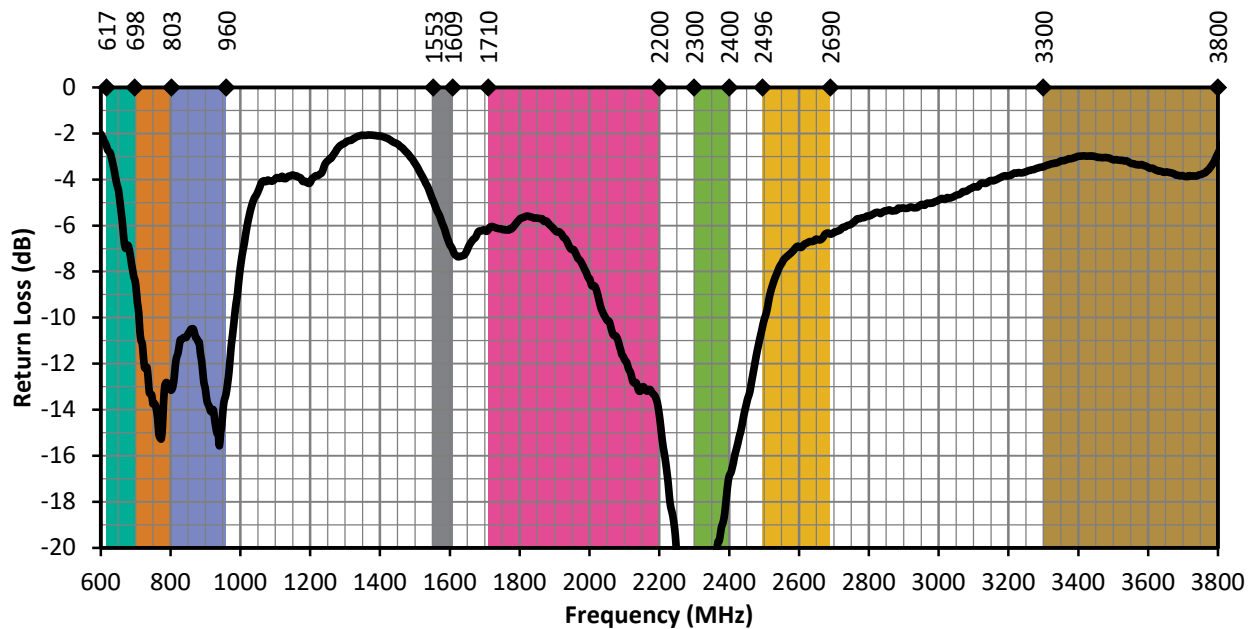

Figure 5: MON-E Return Loss, Edge-Straight, with Frequency Band Highlights

## PEAK GAIN

The peak gain across the antenna bandwidth is shown in Figure 6. Peak gain represents the maximum antenna input power concentration across 3-dimensional space, and therefore peak performance at a given frequency, but does not consider any directionality in the gain pattern.

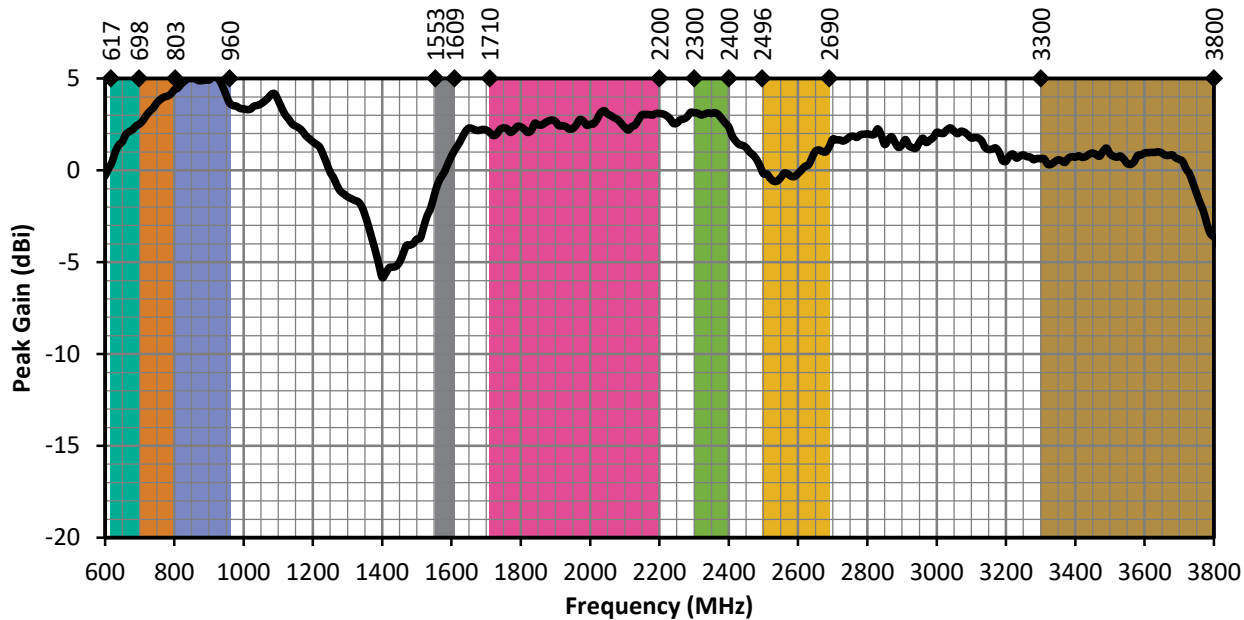

Figure 6: MON-E Peak Gain, Edge-Straight, with Frequency Band Highlights

## AVERAGE GAIN

Average gain (Figure 7), is the average of all antenna gain in 3-dimensional space at each frequency, providing an indication of overall performance without expressing antenna directionality.

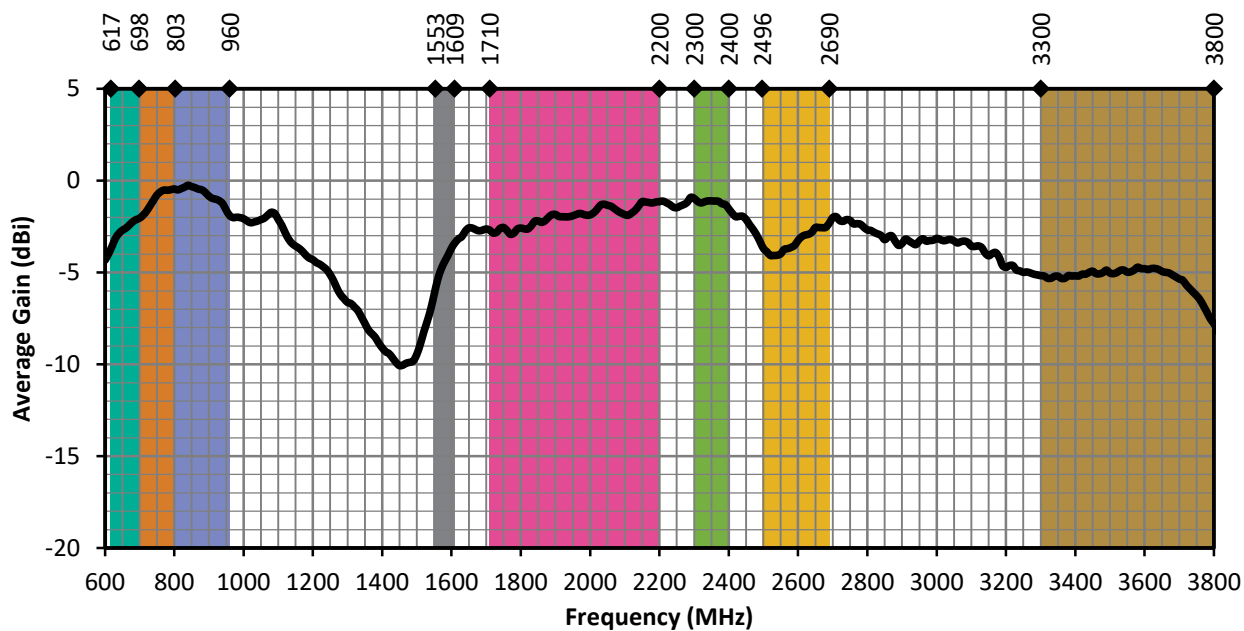

Figure 7: MON-E Antenna Average Gain, Edge-Straight, with Frequency Band Highlights

## PEAK GAIN

Radiation efficiency (Figure 8), shows the ratio of power delivered to the antenna relative to the power radiated at the antenna, expressed as a percentage, where a higher percentage indicates better performance at a given frequency.

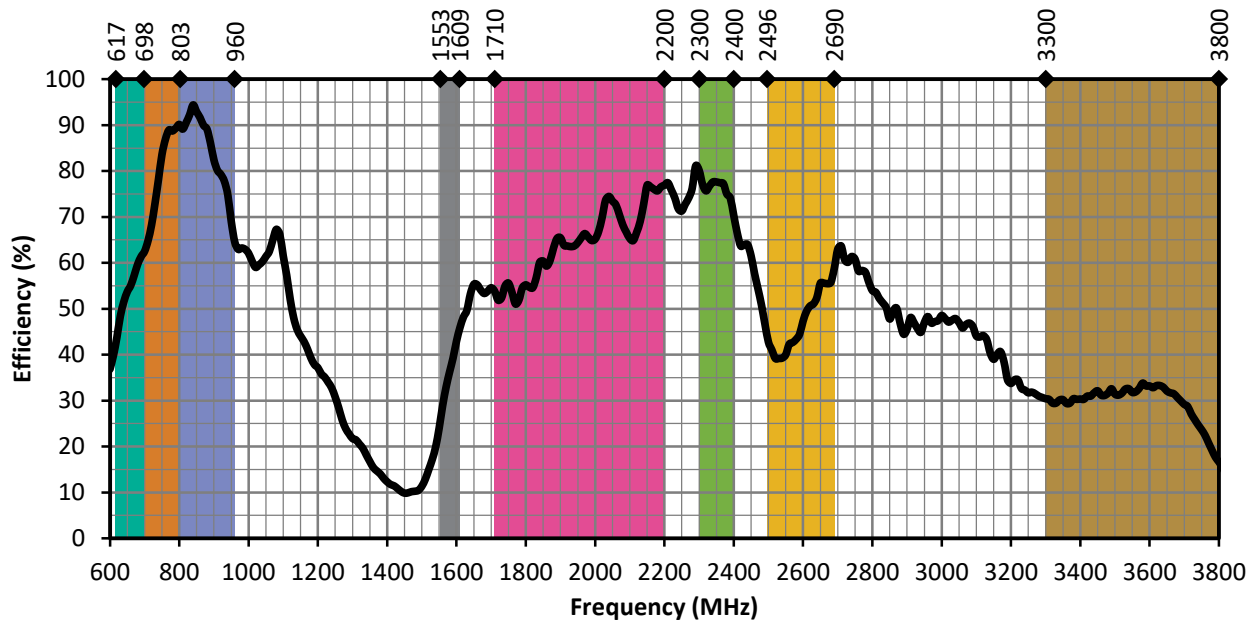

Figure 8: MON-E Antenna Radiation Efficiency, Edge-Straight, with Frequency Band Highlights

## RADIATION PATTERNS

Radiation patterns provide information about the directionality and 3-dimensional gain performance of the antenna by plotting gain at specific frequencies in three orthogonal planes. Antenna radiation patterns for an edge straight orientation are shown in Figure 9 using polar plots covering 360 degrees. The antenna graphic at the top of the page provides reference to the plane of the column of plots below it. Note: when viewed with typical PDF viewing software, zooming into radiation patterns is possible to reveal fine detail.

### RADIATION PATTERNS - EDGE OF GROUND PLANE, STRAIGHT



## 610 MHZ TO 700 MHZ (660 MHZ)

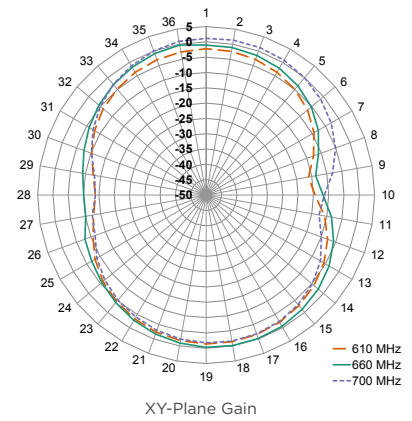
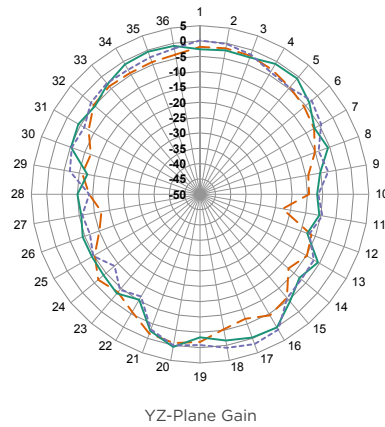
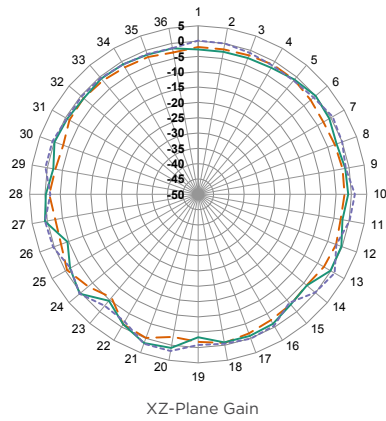

## 700 MHZ TO 800 MHZ (750 MHZ)

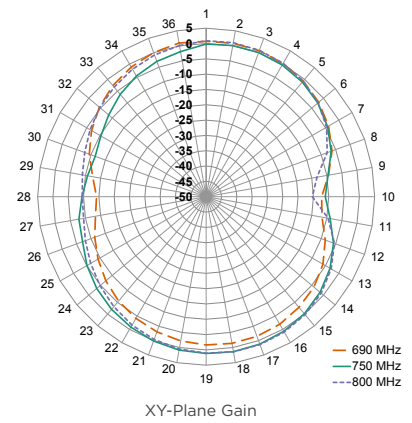
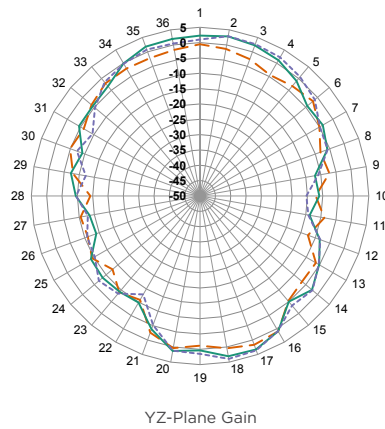
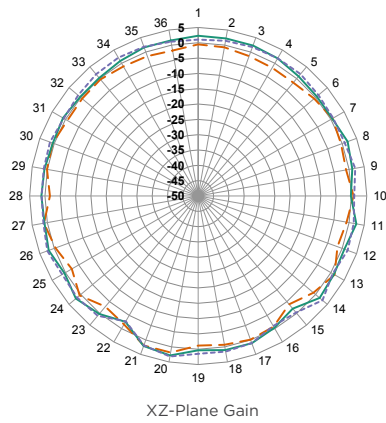

## RADIATION PATTERNS - EDGE OF GROUND PLANE, STRAIGHT

### 790 MHZ TO 960 MHZ (870 MHZ)

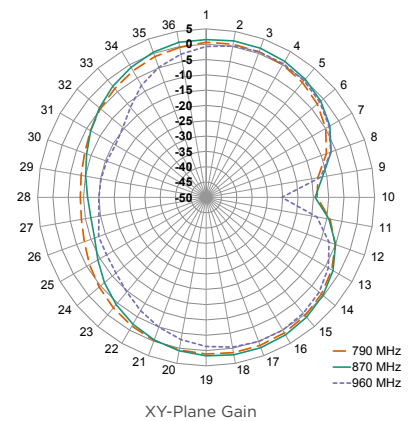
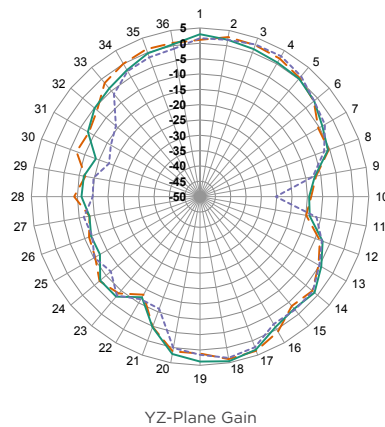
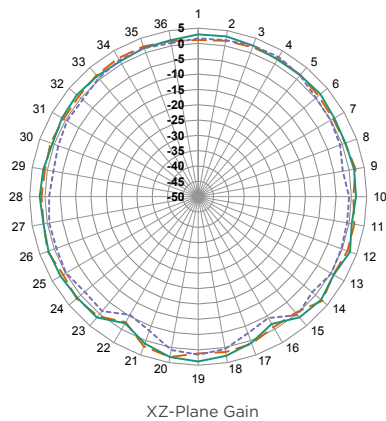



## 1710 MHZ TO 2200 MHZ (1940 MHZ)

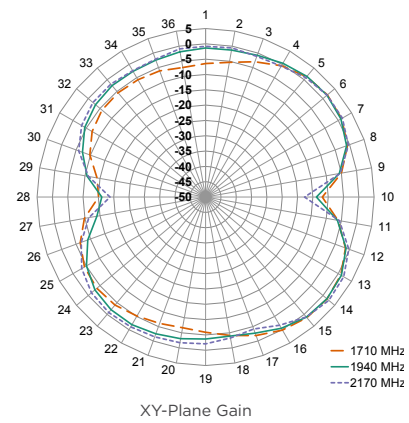
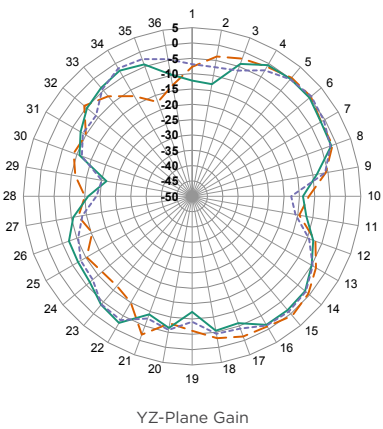
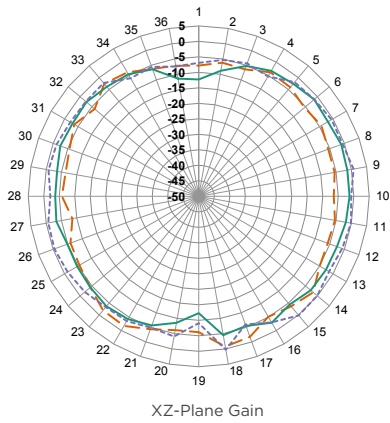

## 2300 MHZ TO 2400 MHZ (2350 MHZ)

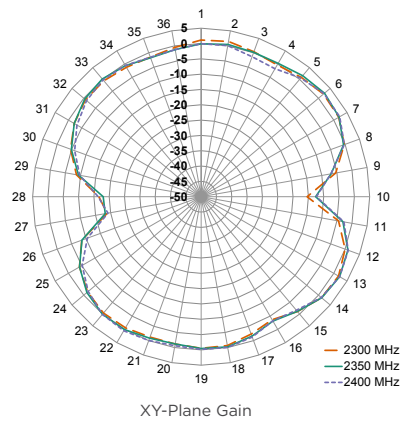
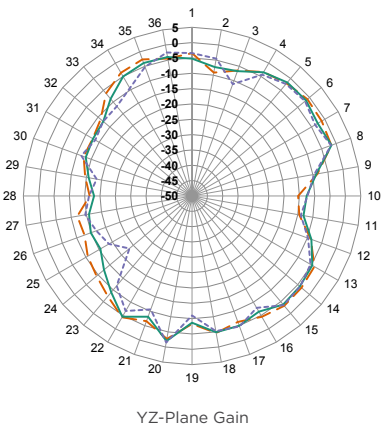
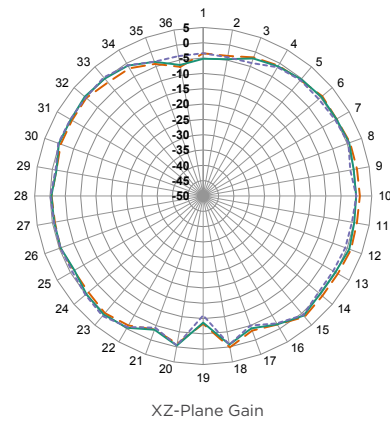

## RADIATION PATTERNS - EDGE OF GROUND PLANE, STRAIGHT

### 2496 MHZ TO 2690 MHZ (2600 MHZ)

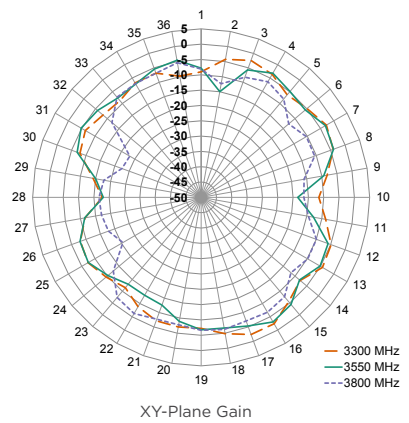
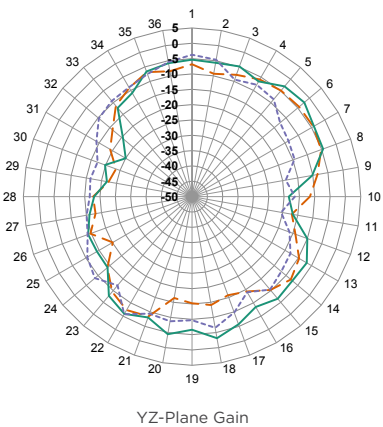
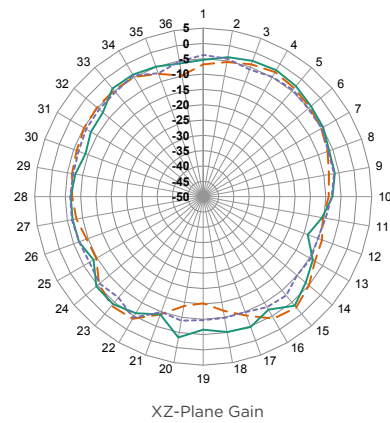

## 3300 MHZ TO 3800 MHZ (3550 MHZ)

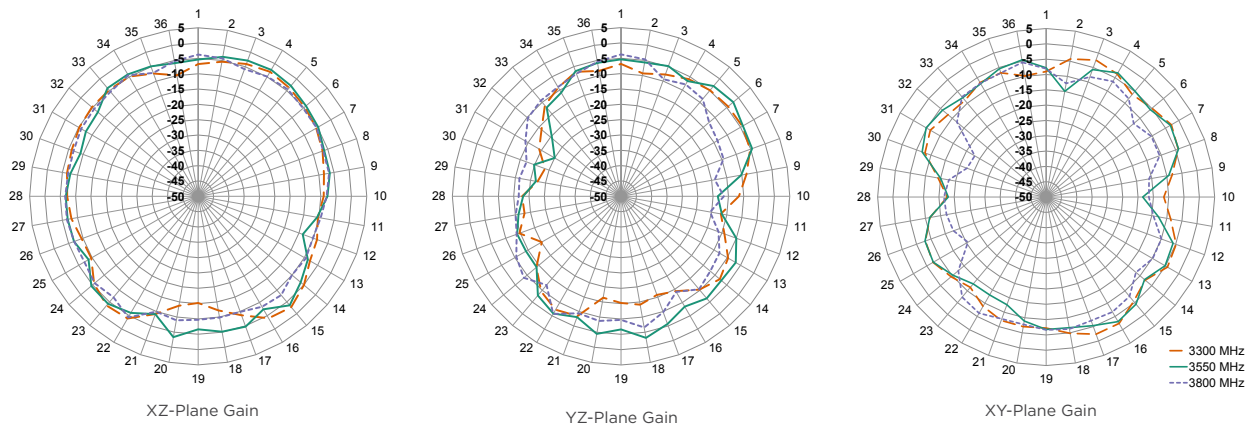

## 1550 MHZ TO 1610 MHZ (1580 MHZ)

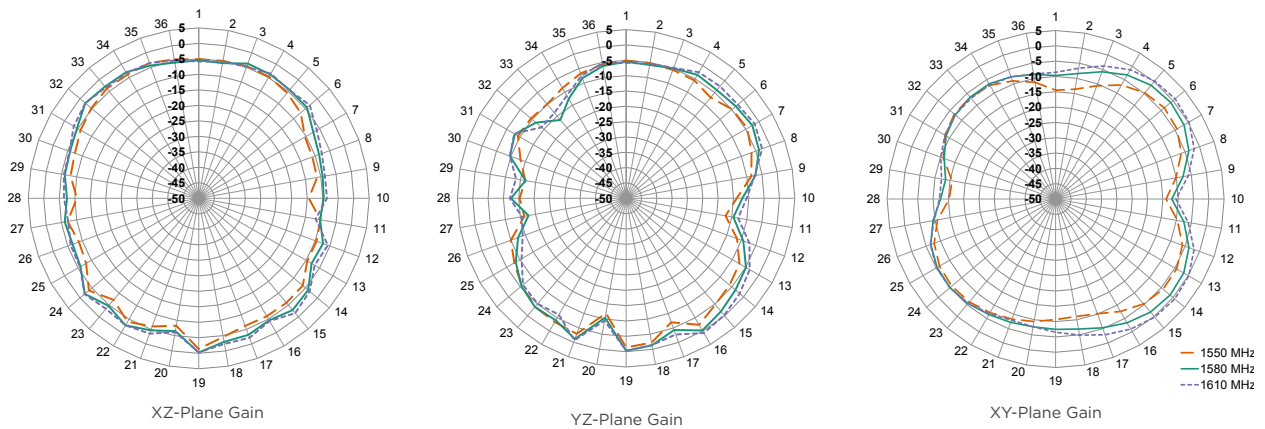

Figure 9: Radiation Patterns for MON-E on Edge of Ground Plane, Straight

## EDGE OF GROUND PLANE, BENT 90 DEGREES

The charts on the following pages represent data taken with the antenna oriented at the edge of the ground plane, bent 90 degrees (Edge-Bent), as shown in Figure 10.

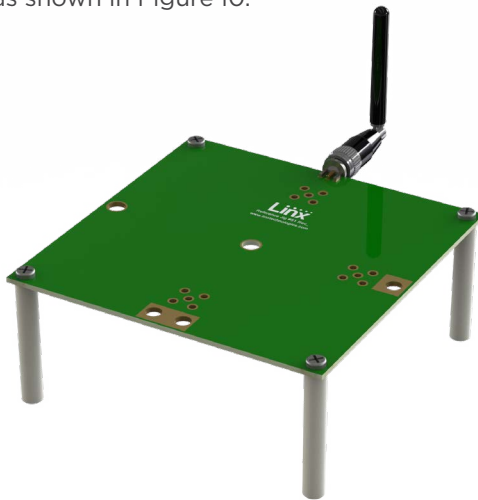

Figure 10: LTE-MON-SMA-E Shown on Edge of Ground Plane, Bent 90 Degrees (Edge-Bent)

## VSWR

Figure 11 provides the voltage standing wave ratio (VSWR) across the antenna bandwidth. VSWR describes the power reflected from the antenna back to the radio. A lower VSWR value indicates better antenna performance at a given frequency. Reflected power is also shown on the right-side vertical axis as a gauge of the percentage of transmitter power reflected back from the antenna.

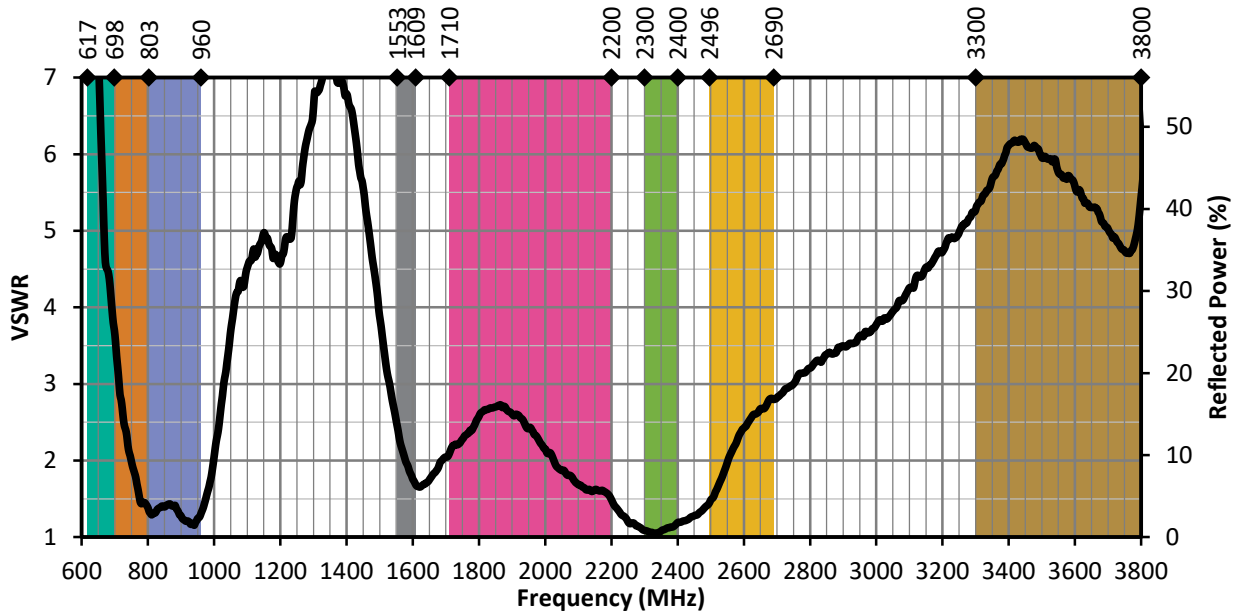

Figure 11: MON-E VSWR, Edge-Bent, with Frequency Band Highlights

## RETURN LOSS

Return loss (Figure 12), represents the loss in power at the antenna due to reflected signals. Like VSWR, a lower return loss value indicates better antenna performance at a given frequency.

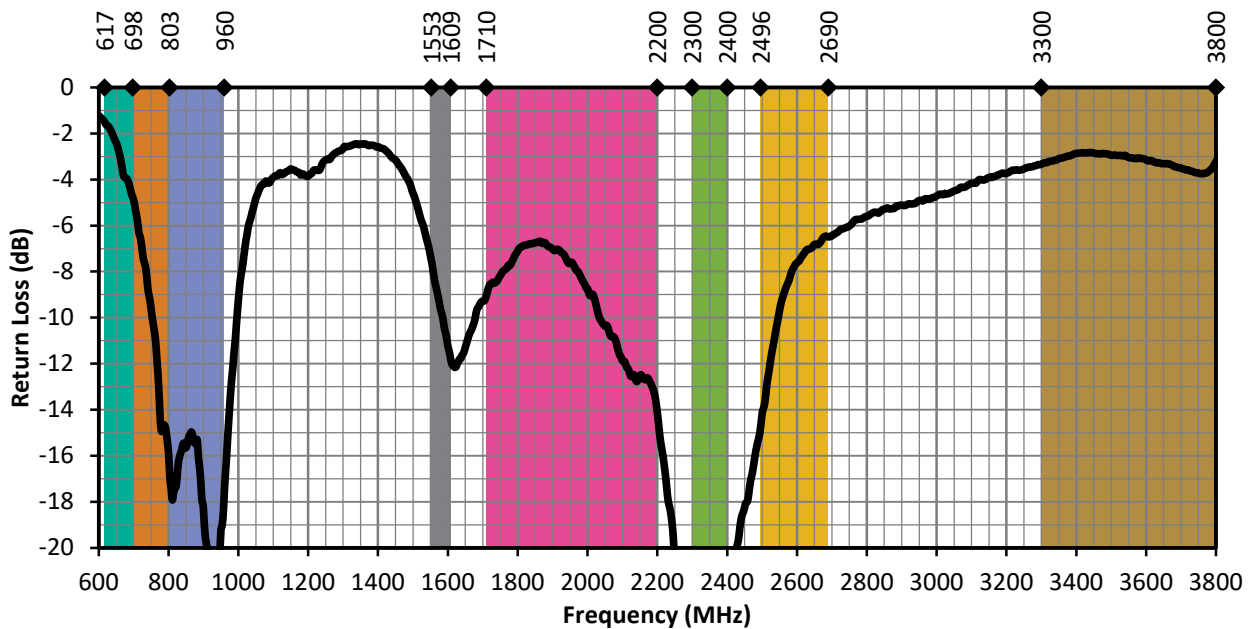

Figure 12: MON-E Return Loss, Edge-Bent, with Frequency Band Highlights

## PEAK GAIN

The peak gain across the antenna bandwidth is shown in Figure 13. Peak gain represents the maximum antenna input power concentration across 3-dimensional space, and therefore peak performance at a given frequency, but does not consider any directionality in the gain pattern.

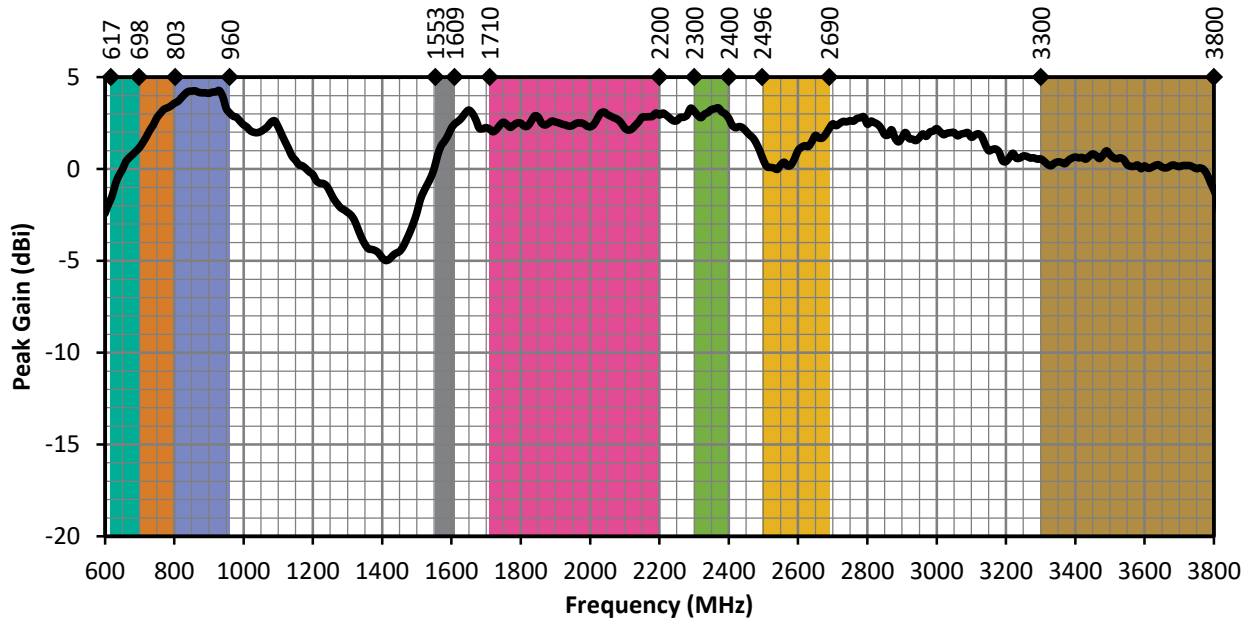

Figure 13: MON-E Peak Gain, Edge-Bent, with Frequency Band Highlights

## AVERAGE GAIN

Average gain (Figure 14), is the average of all antenna gain in 3-dimensional space at each frequency, providing an indication of overall performance without expressing antenna directionality.

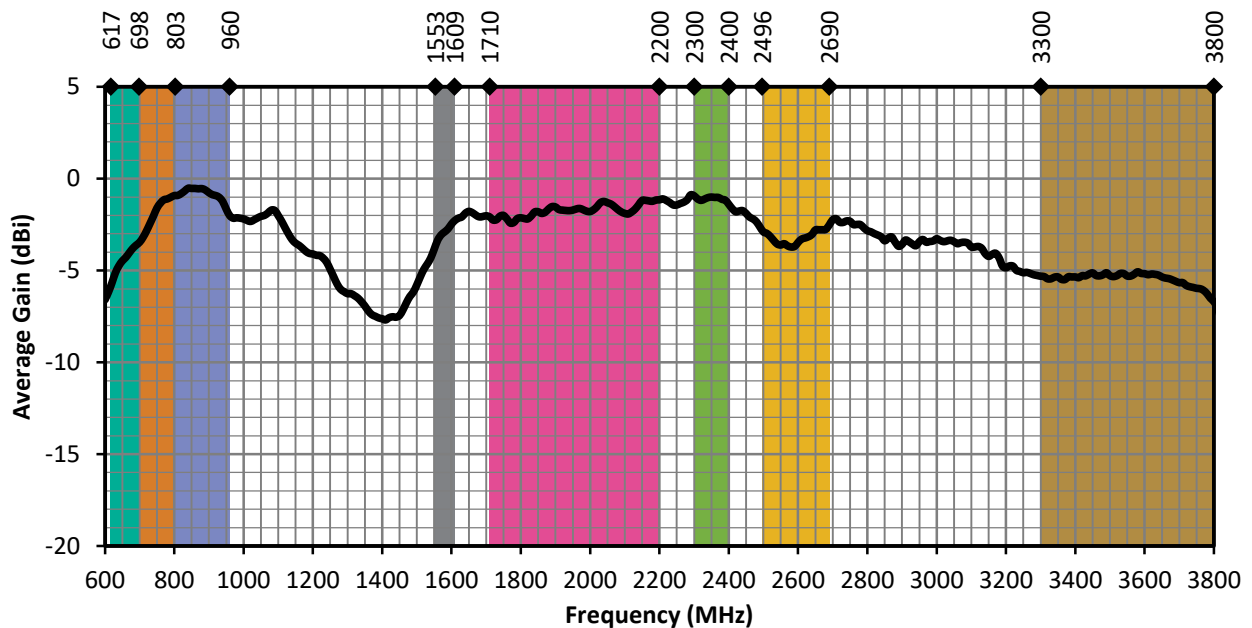

Figure 14: MON-E Antenna Average Gain, Edge-Bent, with Frequency Band Highlights

## RADIATION EFFICIENCY

Radiation efficiency (Figure 15), shows the ratio of power delivered to the antenna relative to the power radiated at the antenna, expressed as a percentage, where a higher percentage indicates better performance at a given frequency.

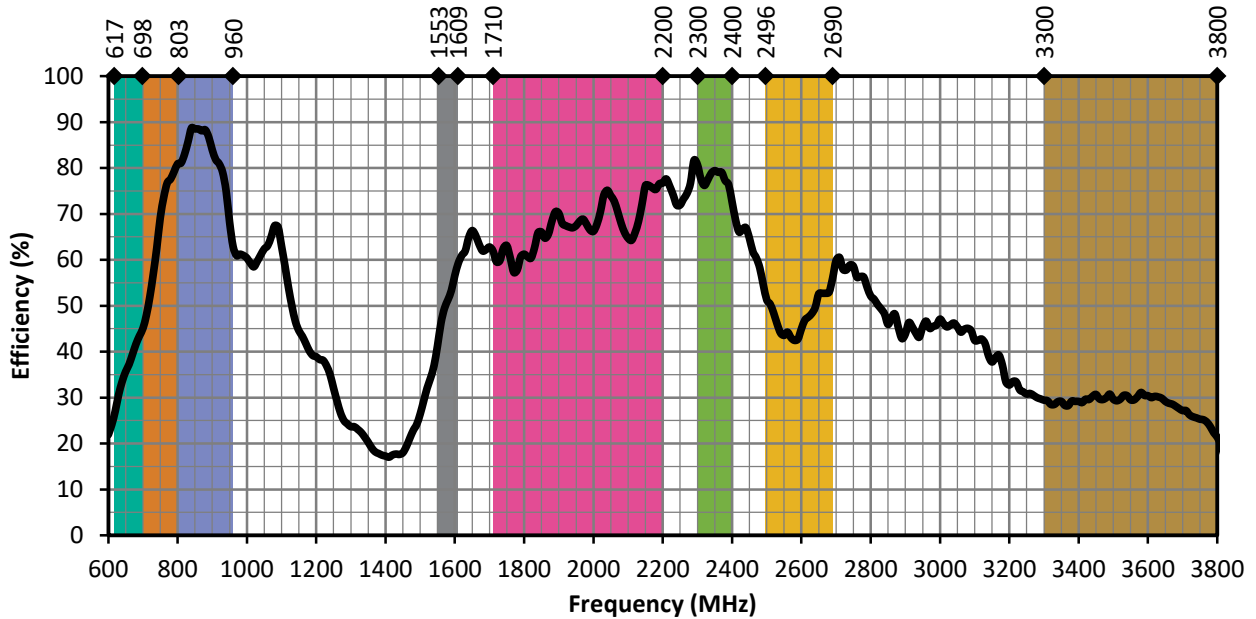

Figure 15: MON-E Antenna Radiation Efficiency, Edge-Bent, with Frequency Band Highlights

## RADIATION PATTERNS

Radiation patterns provide information about the directionality and 3-dimensional gain performance of the antenna by plotting gain at specific frequencies in three orthogonal planes. Antenna radiation patterns for a bent 90 degree orientation are shown in Figure 16 using polar plots covering 360 degrees. The antenna graphic at the top of the page provides reference to the plane of the column of plots below it. Note: when viewed with typical PDF viewing software, zooming into radiation patterns is possible to reveal fine detail.

## RADIATION PATTERNS - EDGE OF GROUND PLANE, BENT 90 DEGREES



## 610 MHZ TO 700 MHZ (660 MHZ)

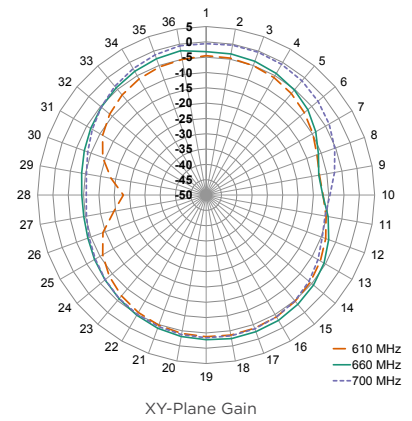
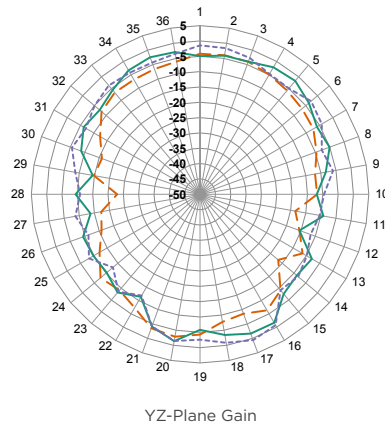
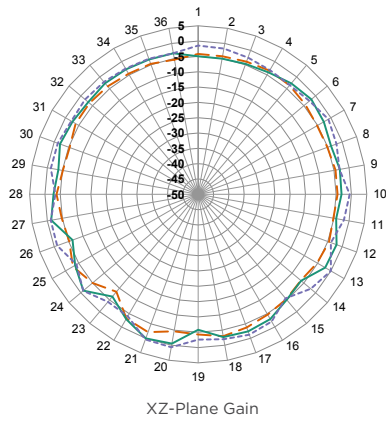

## 700 MHZ TO 800 MHZ (750 MHZ)

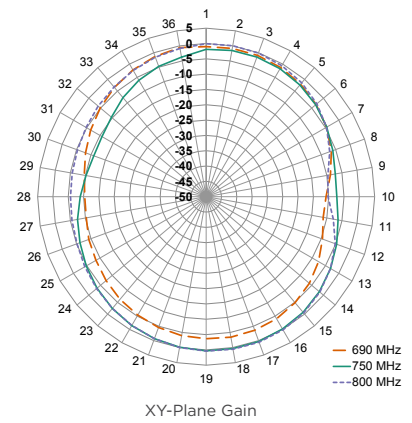
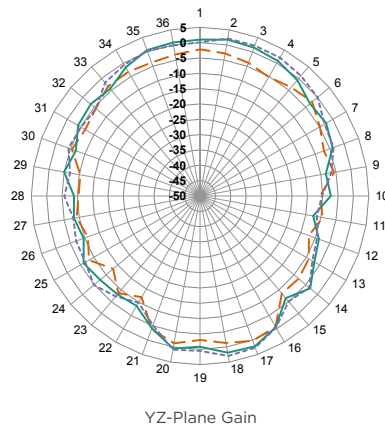
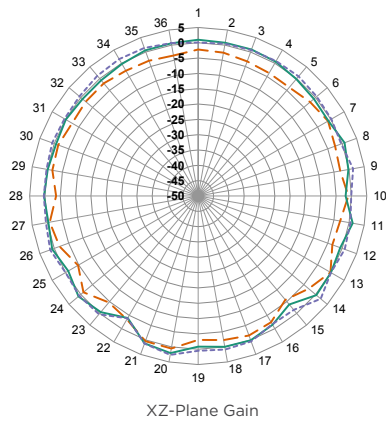

## RADIATION PATTERNS - EDGE OF GROUND PLANE, BENT 90 DEGREES

### 790 MHZ TO 960 MHZ (870 MHZ)

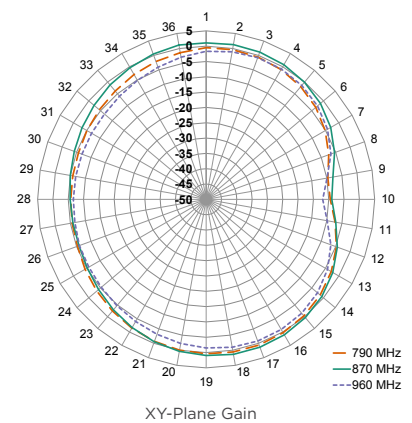
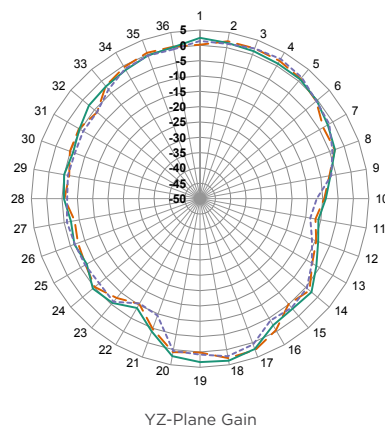
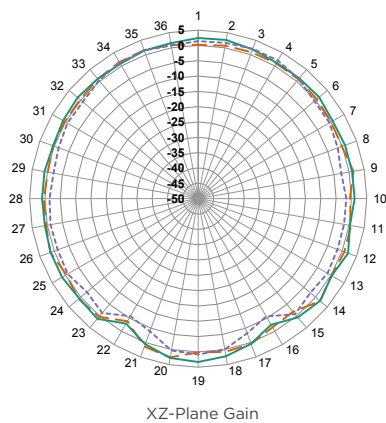



## 1710 MHZ TO 2200 MHZ (1940 MHZ)

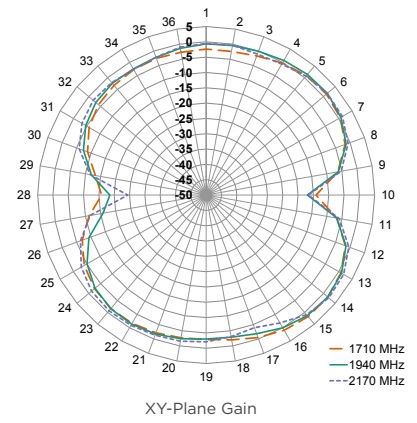
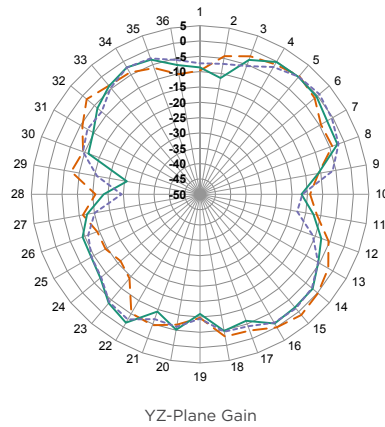
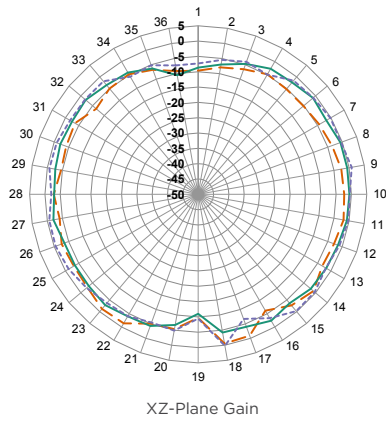

## 2300 MHZ TO 2400 MHZ (2350 MHZ)

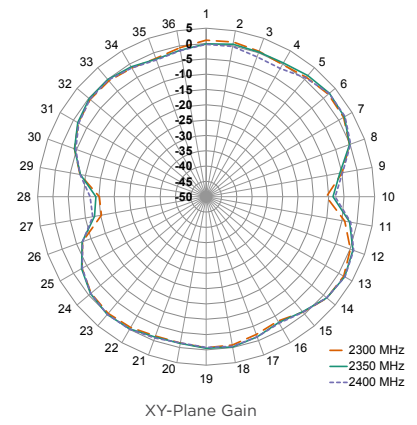
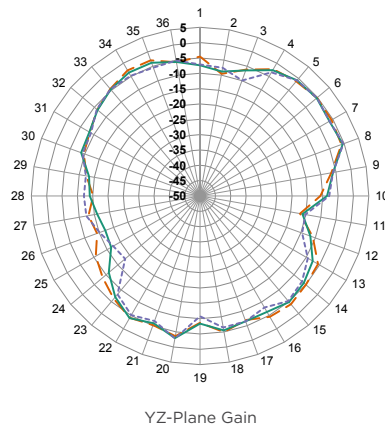
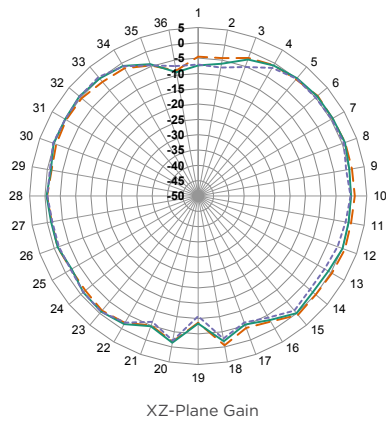

## RADIATION PATTERNS - EDGE OF GROUND PLANE, BENT 90 DEGREES

### 2496 MHZ TO 2690 MHZ (2600 MHZ)

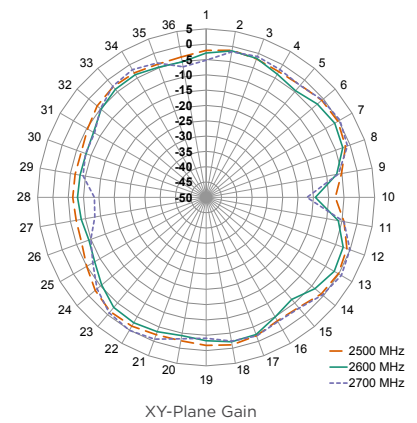
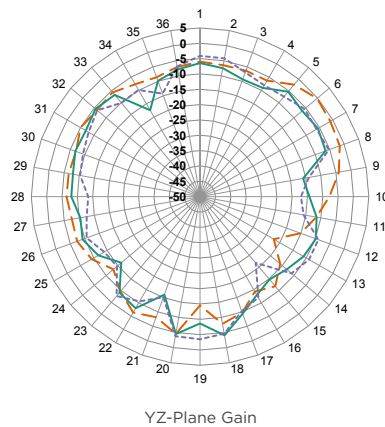
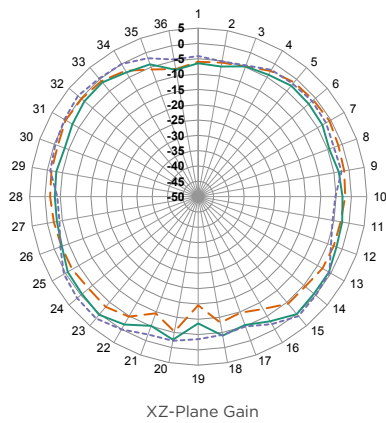

### 3300 MHZ TO 3800 MHZ (3550 MHZ)

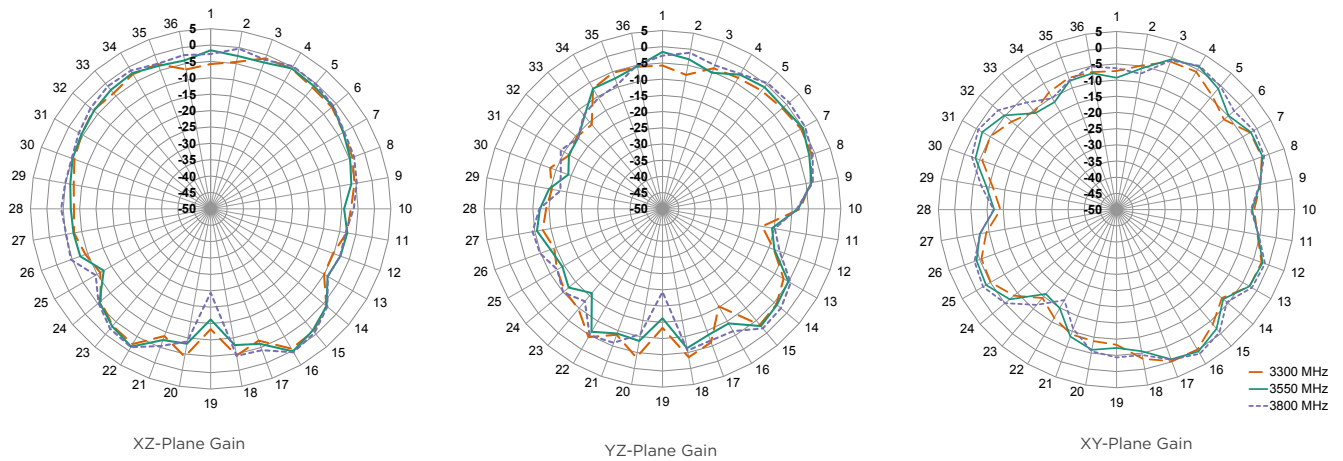

### 1550 MHZ TO 1610 MHZ (1580 MHZ)

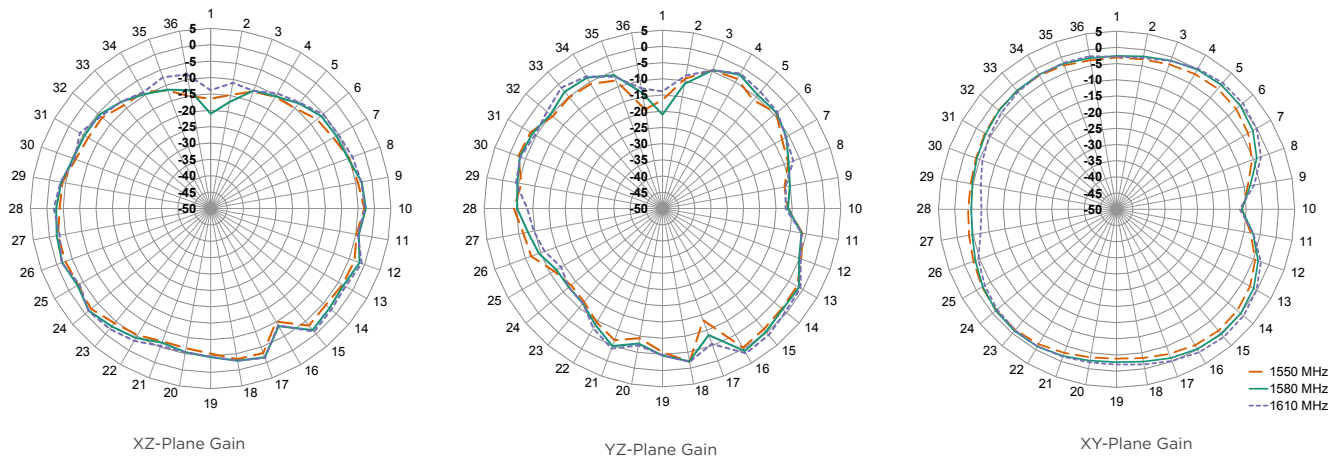

Figure 16: Radiation Patterns for MON-E on Edge of Ground Plane, Bent at 90 Degrees



---

## ANTENNA DEFINITIONS AND USEFUL FORMULAS

**VSWR** - Voltage Standing Wave Ratio. VSWR is a unitless ratio that describes the power reflected from the antenna back to the radio. A lower VSWR value indicates better antenna performance at a given frequency. VSWR is easily derived from Return Loss.

$$\text{VSWR} = \frac{10^{\left[\frac{\text{Return Loss}}{20}\right]} + 1}{10^{\left[\frac{\text{Return Loss}}{20}\right]} - 1}$$

**Return Loss** - Return loss represents the loss in power at the antenna due to reflected signals, measured in decibels. A lower return loss value indicates better antenna performance at a given frequency. Return Loss is easily derived from VSWR.

$$\text{Return Loss} = -20 \log_{10} \left[ \frac{\text{VSWR} - 1}{\text{VSWR} + 1} \right]$$

**Efficiency ( $\eta$ )** - The total power radiated from an antenna divided by the input power at the feed point of the antenna as a percentage.

**Total Radiated Efficiency** - (TRE) The total efficiency of an antenna solution comprising the radiation efficiency of the antenna and the transmitted (forward) efficiency from the transmitter.

$$\text{TRE} = \eta \cdot \left( 1 - \left( \frac{\text{VSWR} - 1}{\text{VSWR} + 1} \right)^2 \right)$$

**Gain** - The ratio of an antenna's efficiency in a given direction (G) to the power produced by a theoretical lossless (100% efficient) isotropic antenna. The gain of an antenna is almost always expressed in decibels.

$$G_{\text{db}} = 10 \log_{10}(G)$$

$$G_{\text{dBd}} = G_{\text{dBi}} - 2.51\text{dB}$$

**Peak Gain** - The highest antenna gain across all directions for a given frequency range. A directional antenna will have a very high peak gain compared to average gain.

**Average Gain** - The average gain across all directions for a given frequency range.

**Maximum Power** - The maximum signal power which may be applied to an antenna feed point, typically measured in watts (W).

**Reflected Power** - A portion of the forward power reflected back toward the amplifier due to a mismatch at the antenna port.

$$\left( \frac{\text{VSWR} - 1}{\text{VSWR} + 1} \right)^2$$

**decibel (dB)** - A logarithmic unit of measure of the power of an electrical signal.

**decibel isotropic (dBi)** - A comparative measure in decibels between an antenna under test and an isotropic radiator.

**decibel relative to a dipole (dBd)** - A comparative measure in decibels between an antenna under test and an ideal half-wave dipole.

**Dipole** - An ideal dipole comprises a straight electrical conductor measuring 1/2 wavelength from end to end connected at the center to a feed point for the radio.

**Isotropic Radiator** - A theoretical antenna which radiates energy equally in all directions as a perfect sphere.

**Omnidirectional** - Term describing an antenna radiation pattern that is uniform in all directions. An isotropic antenna is the theoretical perfect omnidirectional antenna. An ideal dipole antenna has a donut-shaped radiation pattern and other practical antenna implementations will have less perfect but generally omnidirectional radiation patterns which are typically plotted on three axes.

---

## TE TECHNICAL SUPPORT CENTER

USA:	+1 (800) 522-6752
Canada:	+1 (905) 475-6222
Mexico:	+52 (0) 55-1106-0800
Latin/S. America:	+54 (0) 11-4733-2200
Germany:	+49 (0) 6251-133-1999
UK:	+44 (0) 800-267666
France:	+33 (0) 1-3420-8686
Netherlands:	+31 (0) 73-6246-999
China:	+86 (0) 400-820-6015

## te.com

TE Connectivity, TE, TE connectivity (logo), Linx and Linx Technologies are trademarks owned or licensed by the TE Connectivity Ltd. family of companies. All other logos, products and/or company names referred to herein might be trademarks of their respective owners.

The information given herein, including drawings, illustrations and schematics which are intended for illustration purposes only, is believed to be reliable. However, TE Connectivity makes no warranties as to its accuracy or completeness and disclaims any liability in connection with its use. TE Connectivity's obligations shall only be as set forth in TE Connectivity's Standard Terms and Conditions of Sale for this product and in no case will TE Connectivity be liable for any incidental, indirect or consequential damages arising out of the sale, resale, use or misuse of the product. Users of TE Connectivity products should make their own evaluation to determine the suitability of each such product for the specific application.

TE Connectivity warrants to the original end user customer of its products that its products are free from defects in material and workmanship. Subject to conditions and limitations TE Connectivity will, at its option, either repair or replace any part of its products that prove defective because of improper workmanship or materials. This limited warranty is in force for the useful lifetime of the original end product into which the TE Connectivity product is installed. Useful lifetime of the original end product may vary but is not warranted to exceed one (1) year from the original date of the end product purchase.

©2022 TE Connectivity. All Rights Reserved.

11/22 Original