



■ Features

- Plastic housing with class II design
- Built-in active PFC function
- Class 2 power unit
- Standby power consumption <0.5W
- IP67 rating for indoor or outdoor installations
- Function: 3 in 1 dimming (dim-to-off)
- Typical lifetime >50000hours
- 5 years warranty

■ Applications

- LED panel lighting
- LED downlight
- LED decorative lighting
- LED tunnel lighting
- Moving sign
- Type “HL” for use in Class I, Division 2 hazardous (Classified) location

■ Description

NPF-60D series is a 60W AC/DC LED driver featuring the constant current mode output. NPF-60D operates from 90~305VAC and offers models with different rated voltage ranging between 12V and 54V. Thanks to the high efficiency up to 90%, with the fanless design, the entire series is able to operate for -40°C~+85°C case temperature under free air convection. The entire series is rated with IP67 ingress protection level and is suitable to work for a variety of applications at dry, damp or wet locations. NPF-60D is equipped with the 3 in 1 dimming function so as to provide the design flexibility for LED lighting system.

■ Model Encoding

NPF - 60 D - 24

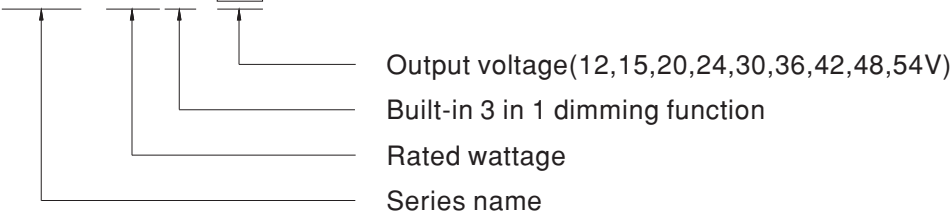

SPECIFICATION

| MODEL | | NPF-60D-12 <input type="checkbox"/> | NPF-60D-15 <input type="checkbox"/> | NPF-60D-20 <input type="checkbox"/> | NPF-60D-24 <input type="checkbox"/> | NPF-60D-30 <input type="checkbox"/> | NPF-60D-36 <input type="checkbox"/> | NPF-60D-42 <input type="checkbox"/> | NPF-60D-48 <input type="checkbox"/> | NPF-60D-54 <input type="checkbox"/> | |
|--------------|--|---|-------------------------------------|-------------------------------------|-------------------------------------|-------------------------------------|-------------------------------------|-------------------------------------|-------------------------------------|-------------------------------------|--|
| OUTPUT | RATED CURRENT | 5A | 4A | 3A | 2.5A | 2A | 1.67A | 1.43A | 1.25A | 1.12A | |
| | RATED POWER | 60W | 60W | 60W | 60W | 60W | 60.12W | 60.06W | 60W | 60.48W | |
| | CONSTANT CURRENT REGION | 7.2 ~ 12V | 9 ~ 15V | 12 ~ 20V | 14.4 ~ 24V | 18 ~ 30V | 21.6 ~ 36V | 25.2 ~ 42V | 28.8 ~ 48V | 32.4 ~ 54V | |
| | CURRENT RIPPLE | 5.0% max. @rated current | | | | | | | | | |
| | CURRENT TOLERANCE | ±5.0% | | | | | | | | | |
| | SET UP TIME <small>Note.3</small> | 500ms/115VAC, 230VAC | | | | | | | | | |
| INPUT | VOLTAGE RANGE <small>Note.2</small> | 90 ~ 305VAC 127 ~ 431VDC (Please refer to "STATIC CHARACTERISTIC" section) | | | | | | | | | |
| | FREQUENCY RANGE | 47 ~ 63Hz | | | | | | | | | |
| | POWER FACTOR (Typ.) | PF ≥ 0.97/115VAC, PF ≥ 0.95/230VAC, PF ≥ 0.92/277VAC@full load (Please refer to "POWER FACTOR (PF) CHARACTERISTIC" section) | | | | | | | | | |
| | TOTAL HARMONIC DISTORTION | THD < 20% (@load ≥ 60%/115VAC, 230VAC; @load ≥ 75%/277VAC) (Please refer to "TOTAL HARMONIC DISTORTION(THD)" section) | | | | | | | | | |
| | EFFICIENCY(Typ.) | 86% | 87% | 88% | 89% | 90% | 90% | 90% | 90% | 90% | |
| | AC CURRENT (Typ.) | 0.8A / 115VAC | | 0.4A / 230VAC | | 0.32A / 277VAC | | | | | |
| | INRUSH CURRENT(Typ.) | COLD START 50A(twidth=270μs measured at 50% Ipeak) at 230VAC; Per NEMA 410 | | | | | | | | | |
| | MAX. NO. of PSUs on 16A CIRCUIT BREAKER | 9 units (circuit breaker of type B) / 16 units (circuit breaker of type C) at 230VAC | | | | | | | | | |
| | LEAKAGE CURRENT | <0.25mA / 277VAC | | | | | | | | | |
| | STANDBY POWER CONSUMPTION | <0.5W | | | | | | | | | |
| PROTECTION | OVER CURRENT | 95 ~ 108% Constant current limiting, recovers automatically after fault condition is removed | | | | | | | | | |
| | SHORT CIRCUIT | Hiccup mode, recovers automatically after fault condition is removed | | | | | | | | | |
| | OVER VOLTAGE | 15 ~ 17V | 17.5 ~ 21V | 23 ~ 27V | 28 ~ 34V | 34 ~ 40V | 41 ~ 46V | 46 ~ 54V | 54 ~ 60V | 59 ~ 66V | |
| | | Shut down o/p voltage, re-power on to recover | | | | | | | | | |
| | OVER TEMPERATURE | Shut down o/p voltage, re-power on to recover | | | | | | | | | |
| ENVIRONMENT | WORKING TEMP. | Tcase=-40 ~ +85°C (Please refer to " OUTPUT LOAD vs TEMPERATURE" section) | | | | | | | | | |
| | MAX. CASE TEMP. | Tcase=+85°C | | | | | | | | | |
| | WORKING HUMIDITY | 20 ~ 95% RH non-condensing | | | | | | | | | |
| | STORAGE TEMP., HUMIDITY | -40 ~ +80°C, 10 ~ 95% RH | | | | | | | | | |
| | TEMP. COEFFICIENT | ±0.03%/°C (0 ~ 50°C) | | | | | | | | | |
| | VIBRATION | 10 ~ 500Hz, 5G 12min./1cycle, period for 72min. each along X, Y, Z axes | | | | | | | | | |
| SAFETY & EMC | SAFETY STANDARDS | UL8750(type"HL"), UL879(for 12V,24V only), CSA C22.2 No. 250.13-12, ENEC BS EN/EN61347-1, BS EN/EN61347-2-13, BS EN/EN62384 independent, EAC TP TC 004,GB19510.1,GB19510.14,IP67 approved ; Design refer to BS EN/EN60335-1 | | | | | | | | | |
| | WITHSTAND VOLTAGE | I/P-O/P:3.75KVAC | | | | | | | | | |
| | ISOLATION RESISTANCE | I/P-O/P:100M Ohms / 500VDC / 25°C / 70% RH | | | | | | | | | |
| | EMC EMISSION | Compliance to BS EN/EN55015, BS EN/EN61000-3-2 Class C (@ load ≥ 60%); BS EN/EN61000-3-3;GB17743 and GB17625.1,EAC TP TC 020 | | | | | | | | | |
| | EMC IMMUNITY | Compliance to BS EN/EN61000-4-2,3,4,5,6,8,11; BS EN/EN61547, light industry level(surge immunity Line-Line 2KV); EAC TP TC 020 | | | | | | | | | |
| OTHERS | MTBF | 1016.1K hrs min. Telcordia SR-332 (Bellcore) ; 314.05K hrs min. MIL-HDBK-217F (25°C) | | | | | | | | | |
| | DIMENSION | 150*53*35mm (L*W*H) | | | | | | | | | |
| | PACKING | 0.49Kg;30pcs/15.7Kg/1.0CUFT | | | | | | | | | |
| NOTE | <ol style="list-style-type: none"> All parameters NOT specially mentioned are measured at 230VAC input, rated current and 25°C of ambient temperature. De-rating may be needed under low input voltages. Please refer to "STATIC CHARACTERISTIC" sections for details. Length of set up time is measured at first cold start. Turning ON/OFF the driver may lead to increase of the set up time. The standby power consumption is specified for 230VAC. The driver is considered as a component that will be operated in combination with final equipment. Since EMC performance will be affected by the complete installation, the final equipment manufacturers must re-qualify EMC Directive on the complete installation again. This series meets the typical life expectancy of >50,000 hours of operation when Tcase, particularly (Ⓢ) point (or TMP, per DLC), is about 75°C or less. Please refer to the warranty statement on MEAN WELL's website at http://www.meanwell.com The ambient temperature derating of 3.5°C/1000m with fanless models and of 5°C/1000m with fan models for operating altitude higher than 2000m(6500ft). For any application note and IP water proof function installation caution, please refer our user manual before using. https://www.meanwell.com/Upload/PDF/LED_EN.pdf <p>※ Product Liability Disclaimer : For detailed information, please refer to https://www.meanwell.com/serviceDisclaimer.aspx</p> | | | | | | | | | | |

■ BLOCK DIAGRAM

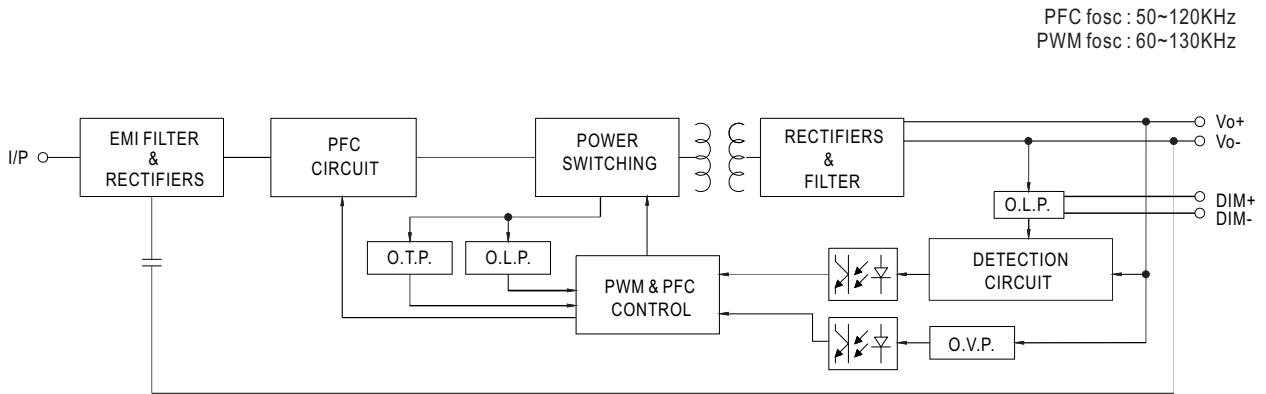

■ DRIVING METHODS OF LED MODULE

※ This series works in constant current mode to directly drive the LEDs.

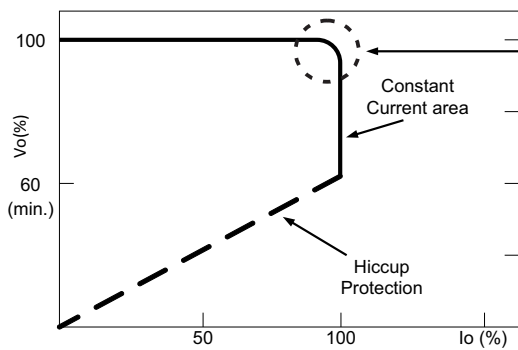

Typical LED power supply I-V curve

In the constant current region, the highest voltage at the output of the driver depends on the configuration of the end systems.

Should there be any compatibility issues, please contact MEAN WELL.

■ DIMMING OPERATION



※ **3 in 1 dimming function**

- Output constant current level can be adjusted by applying one of the three methodologies between DIM+ and DIM-: 0 ~ 10VDC, or 10V PWM signal or resistance.
- Direct connecting to LEDs is suggested. It is not suitable to be used with additional drivers.
- Dimming source current from power supply: 100μA (typ.)

◎ Applying additive 0 ~ 10VDC

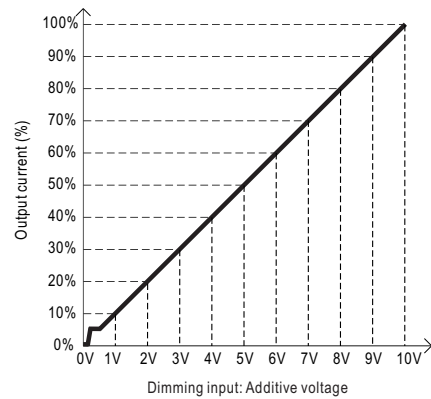
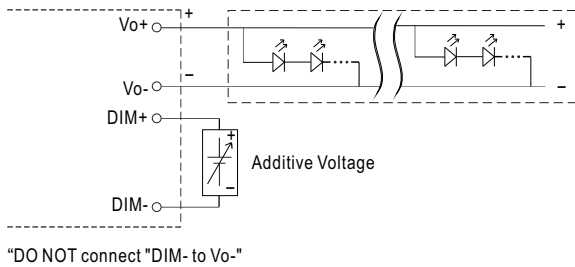

◎ Applying additive 10V PWM signal (frequency range 100Hz ~ 3KHz):

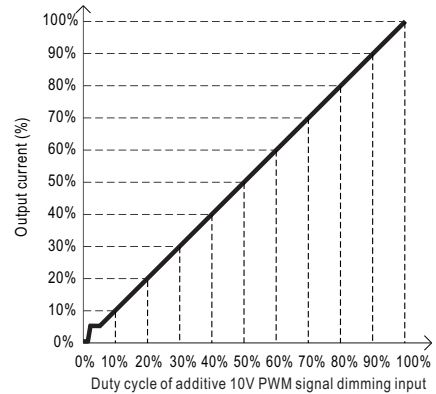
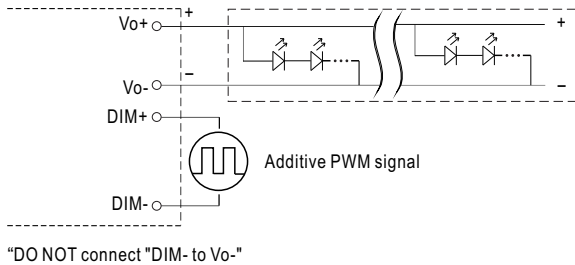

◎ Applying additive resistance:

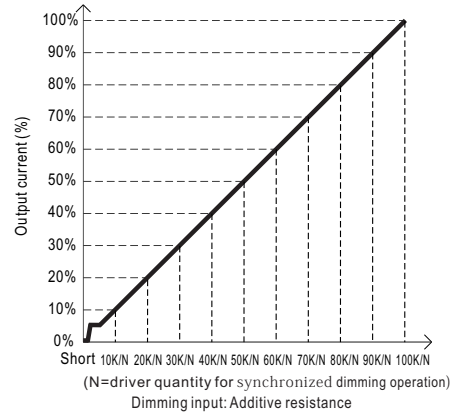
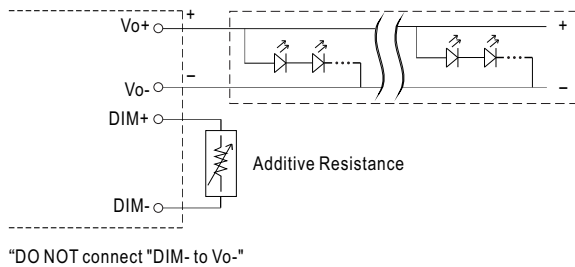

Note : 1. Min. dimming level is about 6% and the output current is not defined when 0% < Iout < 6%.

2. The output current could drop down to 0% when dimming input is about 0kΩ or 0Vdc, or 10V PWM signal with 0% duty cycle.

OUTPUT LOAD vs TEMPERATURE

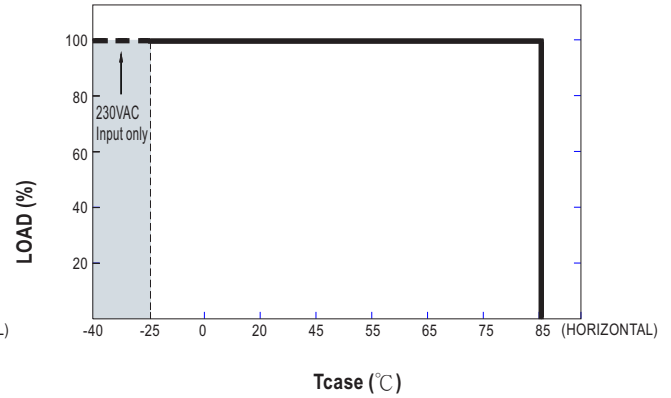
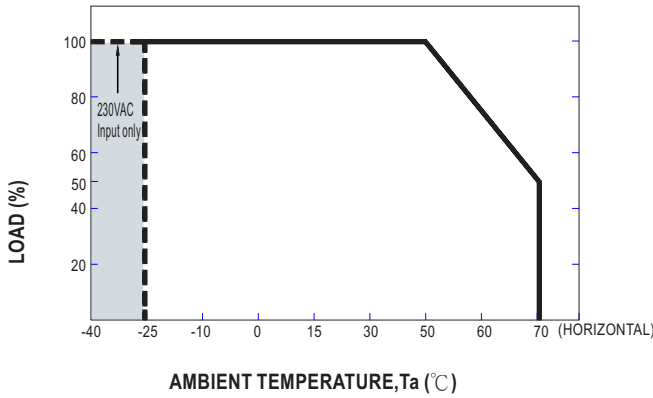

STATIC CHARACTERISTIC

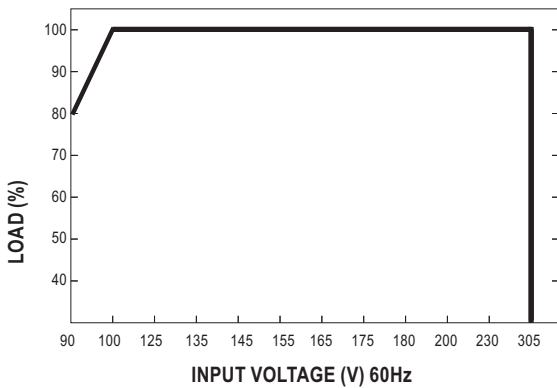

※ De-rating is needed under low input voltage.

POWER FACTOR (PF) CHARACTERISTIC

※ Tcase at 75°C

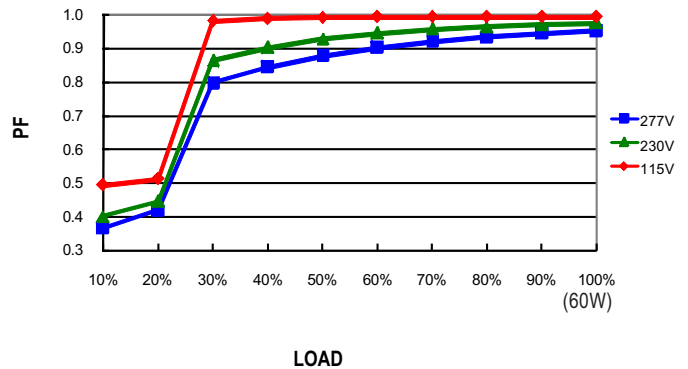

TOTAL HARMONIC DISTORTION (THD)

※ 48V Model, Tcase at 75°C

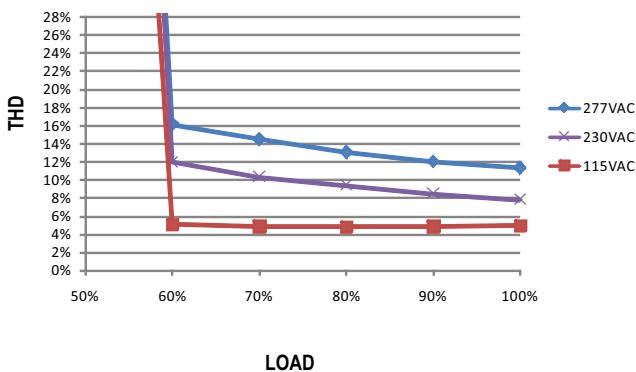

EFFICIENCY vs LOAD

NPF-60D series possess superior working efficiency that up to 90% can be reached in field applications.

※ 48V Model, Tcase at 75°C

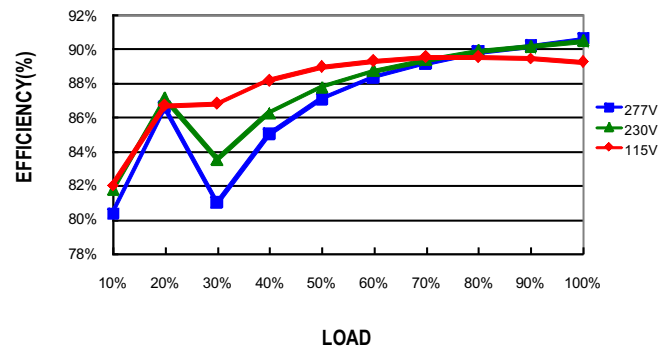

■ LIFE TIME

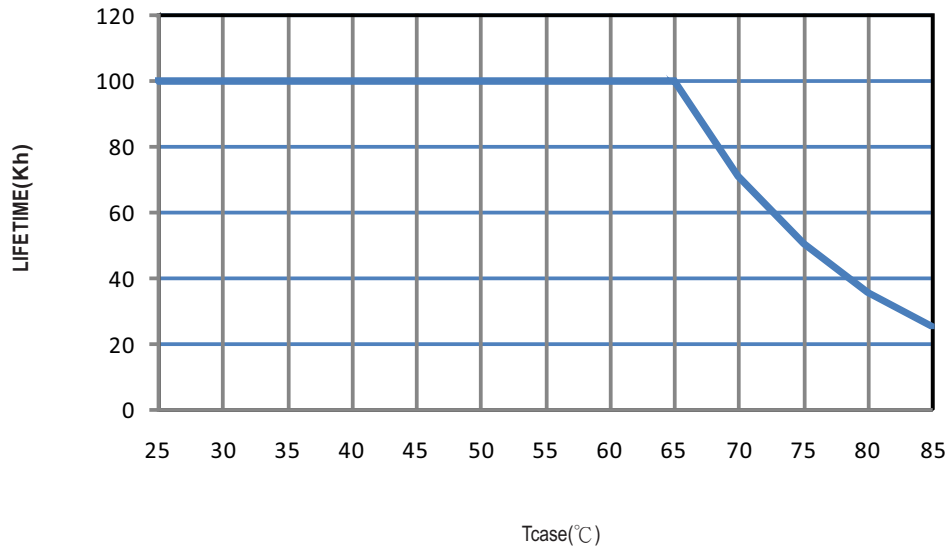

MECHANICAL SPECIFICATION

Case No. NPF-60A Unit:mm

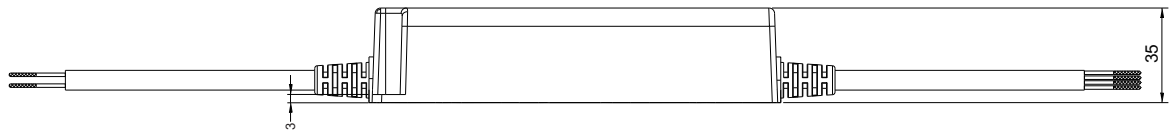
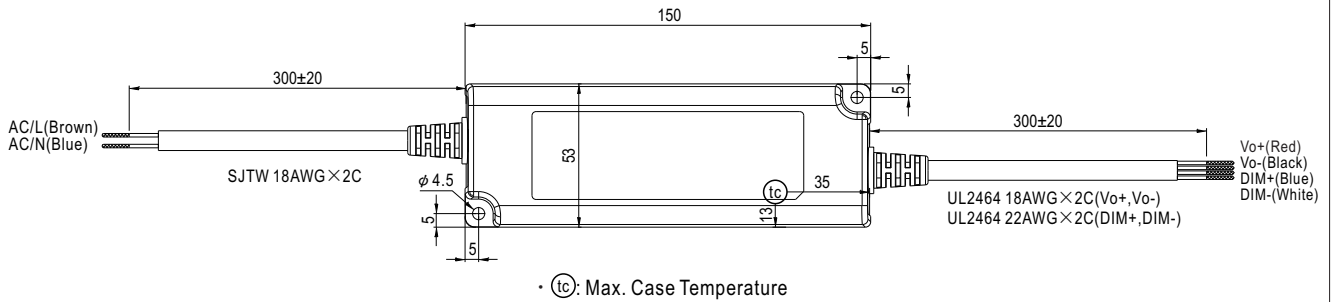

Recommend Mounting Direction

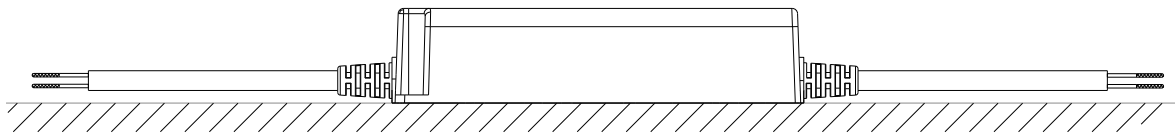

INSTALLATION MANUAL

Please refer to : <http://www.meanwell.com/manual.html>