

Data sheet | Item number: 2092-1125

1-conductor female connector; push-button; Push-in CAGE CLAMP®; 2.5 mm²; Pin spacing 5 mm; 5-pole; 2,50 mm²; light gray

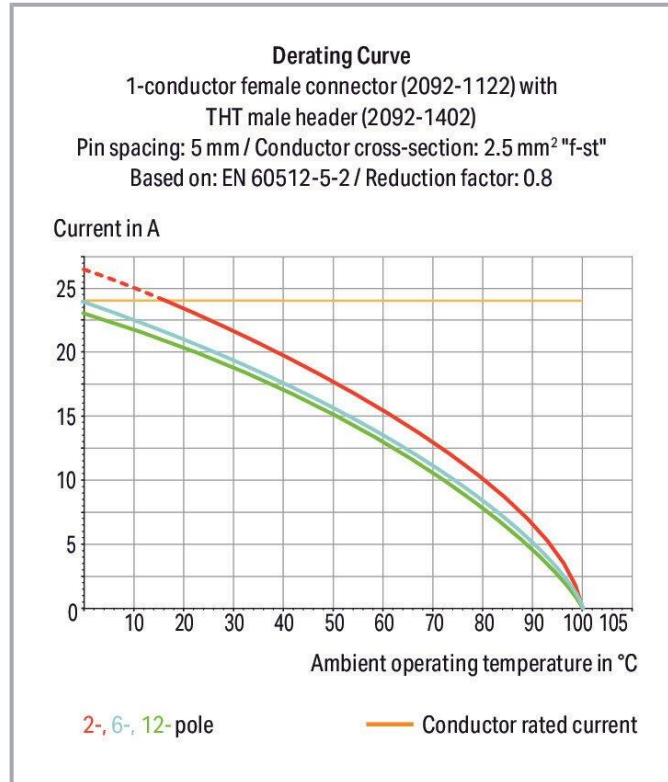

www.wago.com/2092-1125

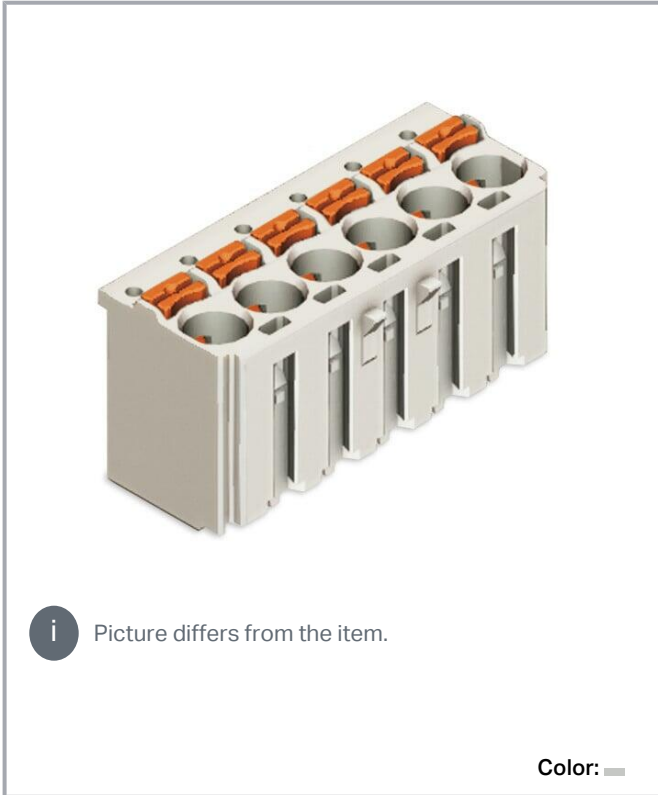

Subject to changes. Please also observe the further product documentation!

WAGO GmbH & Co. KG
Hansastr. 27
32423 Minden
Phone: +49571 887-0 | Fax: +49571 887-169
Email: info.de@wago.com | Web: www.wago.com

Do you have any questions about our products?
We are always happy to take your call at +49 (571) 887-44222.

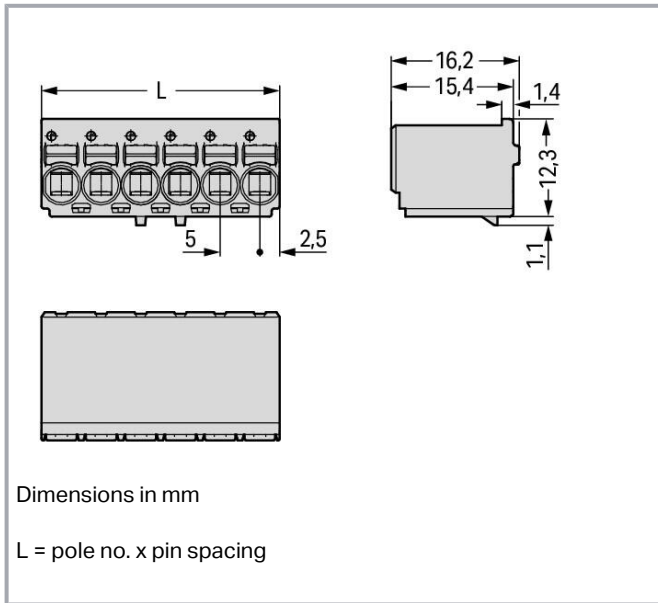

Item description

- Universal connection of all conductor types
- Simple, push-in termination of solid and ferruled conductors
- Easy-to-use design does not require special tools
- Ability to wire while mated or unmated
- Testing parallel to conductor entry – tip contact
- Also available with gripping plates
- Integrated locking latches prevent accidental disconnection

Data

Notes

Safety information

The **picoMAX® Pluggable Connection System** includes connectors without breaking capacity in accordance with DIN EN 61984. When used as intended, these connectors must not be connected /disconnected when live or under load. The circuit design should ensure header pins, which can be touched, are not live when unmated.

Variants:

Direct marking

Other versions (or variants) can be requested from WAGO Sales or configured at <https://configurator.wago.com/>.

Electrical data

Subject to changes. Please also observe the further product documentation!

WAGO GmbH & Co. KG
 Hansastr. 27
 32423 Minden
 Phone: +49571 887-0 | Fax: +49571 887-169
 Email: info.de@wago.com | Web: www.wago.com

Do you have any questions about our products?
 We are always happy to take your call at +49 (571) 887-44222.



Ratings per IEC/EN

| | |
|-------------------------------|---|
| Ratings per | IEC/EN 60664-1 |
| Nominal voltage (III/3) | 250 V |
| Rated impulse voltage (III/3) | 4 kV |
| Rated voltage (III/2) | 320 V |
| Rated impulse voltage (III/2) | 4 kV |
| Nominal voltage (II/2) | 630 V |
| Rated surge voltage (II/2) | 4 kV |
| Rated current | 16 A |
| Legend (ratings) | (III / 2) ≙ Overvoltage category III / Pollution degree 2 |

Ratings per UL 1059

| | |
|--------------------------------|---------|
| Approvals per | UL 1059 |
| Rated voltage UL (Use Group B) | 300 V |
| Rated current UL (Use Group B) | 15 A |
| Rated voltage UL (Use Group D) | 300 V |
| Rated current UL (Use Group D) | 10 A |

Connection data

| | |
|----------------------------|---|
| Connection points | 5 |
| Total number of potentials | 5 |
| Number of connection types | 1 |
| Number of levels | 1 |

Connection 1

| | |
|---|---|
| Connection technology | Push-in CAGE CLAMP® |
| Actuation type | Push-button |
| Actuation direction 1 | Operation parallel to conductor entry |
| Solid conductor | 0.2 ... 2.5 mm ² / 24 ... 12 AWG |
| Fine-stranded conductor | 0.2 ... 2.5 mm ² / 24 ... 12 AWG |
| Fine-stranded conductor; with insulated ferrule | 0.25 ... 1.5 mm ² |
| Fine-stranded conductor; with uninsulated ferrule | 0.25 ... 2.5 mm ² |
| Strip length | 9 ... 10 mm / 0.35 ... 0.39 inches |
| Pole number | 5 |

Subject to changes. Please also observe the further product documentation!



Physical data

| | |
|-------------|------------------------|
| Pin spacing | 5 mm / 0.197 inches |
| Width | 25 mm / 0.984 inches |
| Height | 16.2 mm / 0.638 inches |
| Depth | 13.4 mm / 0.528 inches |

Mechanical Data

| | |
|--------------------------|-----|
| Variable coding | Yes |
| Anti-rotation protection | Yes |

Plug-in connection

| | |
|--------------------------------------|-------------------------|
| Contact type (pluggable connector) | Female connector/socket |
| Connector (connection type) | for conductor |
| Mismating protection | No |
| Plugging without loss of pin spacing | Yes |
| Locking of plug-in connection | none |

Material Data

| | |
|-----------------------------|--|
| Note (material data) | Information on material specifications can be found here |
| Color | light gray |
| Material group | I |
| Insulation material | Polyphthalamide (PPA GF) |
| Flammability class per UL94 | V0 |
| Clamping spring material | Chrome-nickel spring steel (CrNi) |
| Contact material | Electrolytic copper (E _{Cu}) |
| Contact plating | Tin |
| Fire load | 0.098 MJ |
| Weight | 4.4 g |

Environmental requirements

| | |
|-------------------------|-----------------|
| Limit temperature range | -60 ... +100 °C |
| Processing temperature | -35 ... +60 °C |

Subject to changes. Please also observe the further product documentation!

WAGO GmbH & Co. KG
 Hansastr. 27
 32423 Minden
 Phone: +49571 887-0 | Fax: +49571 887-169
 Email: info.de@wago.com | Web: www.wago.com

Do you have any questions about our products?
 We are always happy to take your call at +49 (571) 887-44222.

Commercial data

| | |
|-----------------------|-------------------------|
| Product Group | 26 (picoMAX Connectors) |
| eCl@ss 10.0 | 27-14-11-06 |
| eCl@ss 9.0 | 27-14-11-06 |
| ETIM 8.0 | EC001284 |
| ETIM 7.0 | EC001284 |
| PU (SPU) | 200 pcs |
| Packaging type | box |
| Country of origin | DE |
| GTIN | 4050821163503 |
| Customs tariff number | 85366990990 |

Environmental Product Compliance

| | |
|------------------------|-------------------------|
| RoHS Compliance Status | Compliant, No Exemption |
|------------------------|-------------------------|

Approvals / Certificates











General approvals

| Logo | Approval | Additional Approval Text | Certificate name |
|--|--|--------------------------|------------------|
| | CB DEKRA Certification B.V. | IEC 61984 | NL-49737 /A1 |
|  | CSA DEKRA Certification B.V. | C22.2 No. 158 | 2362521 |
|  | CSA DEKRA Certification B.V. | C22.2 | 2362521 |
|  | cURus Underwriters Laboratories Inc. | UL 1059 | E45172 |
|  | KEMA/KEUR DEKRA Certification B.V. | EN 61984 | 71-102261 REV.2 |
| | UL Underwriters Laboratories Inc. | UL 1977 | E45171 |

Subject to changes. Please also observe the further product documentation!



Counterpart

| | | |
|--|--|--|
|  | Item no.2092-1405 THT male header; 1.4 mm Ø solder pin; straight; Pin spacing 5 mm; 5-pole; light gray | www.wago.com/2092-1405 |
|  | Item no.2092-1405/005-000 THT male header; 1.4 mm Ø solder pin; straight; clamping collar; Pin spacing 5 mm; 5-pole; light gray | www.wago.com/2092-1405/005-000 |
|  | Item no.2092-1405/205-000 THR male header; 1.4 mm Ø solder pin; straight; clamping collar; Pin spacing 5 mm; 5-pole; light gray | www.wago.com/2092-1405/205-000 |
|  | Item no.2092-1405/200-000 THR male header; 1.4 mm Ø solder pin; straight; Pin spacing 5 mm; 5-pole; light gray | www.wago.com/2092-1405/200-000 |
|  | Item no.2092-1425 THT male header; 1.4 mm Ø solder pin; angled; Pin spacing 5 mm; 5-pole; light gray | www.wago.com/2092-1425 |
|  | Item no.2092-1425/005-000 THT male header; 1.4 mm Ø solder pin; angled; clamping collar; Pin spacing 5 mm; 5-pole; light gray | www.wago.com/2092-1425/005-000 |
|  | Item no.2092-1425/200-000 THR male header; 1.4 mm Ø solder pin; angled; Pin spacing 5 mm; 5-pole; light gray | www.wago.com/2092-1425/200-000 |
|  | Item no.2092-1525/002-000 1-conductor male connector; Push-in CAGE CLAMP®; 2.5 mm ² ; Pin spacing 5 mm; 5-pole; Integrated release lever; 2,50 mm ² ; light gray | www.wago.com/2092-1525/002-000 |
|  | Item no.2092-1425/205-000 THR male header; 1.4 mm Ø solder pin; angled; clamping collar; Pin spacing 5 mm; 5-pole; light gray | www.wago.com/2092-1425/205-000 |
|  | Item no.2092-1505/002-000 1-conductor male connector; Push-in CAGE CLAMP®; 2.5 mm ² ; Pin spacing 5 mm; 5-pole; Gripping plate; 2,50 mm ² ; light gray | www.wago.com/2092-1505/002-000 |
|  | Item no.2092-1635/024-000 Panel feedthrough male connector; clamping collar; 2.5 mm ² ; 5-pole; Pin spacing 5 mm; light gray | www.wago.com/2092-1635/024-000 |

Subject to changes. Please also observe the further product documentation!

**Item no. 2092-1525/020-000**

1-conductor male connector; Push-in CAGE CLAMP®; 2.5 mm²; Pin spacing 5 mm; 5-pole; DIN-35 rail/panel mounting; Snap-in mounting feet; Integrated release lever; 2,50 mm²; light gray

www.wago.com/2092-1525/020-000

**Item no. 2092-1705**

THT male header; 1.4 mm Ø solder pin; straight; Pin spacing 5 mm; 5-pole; black

www.wago.com/2092-1705

**Item no. 2092-1725/200-000**

THR male header; 1.4 mm Ø solder pin; angled; Pin spacing 5 mm; 5-pole; black

www.wago.com/2092-1725/200-000

**Item no. 2092-1705/200-000**

THR male header; 1.4 mm Ø solder pin; straight; Pin spacing 5 mm; 5-pole; black

www.wago.com/2092-1705/200-000

**Item no. 2092-1725**

THT male header; 1.4 mm Ø solder pin; angled; Pin spacing 5 mm; 5-pole; black

www.wago.com/2092-1725

Optional accessories

Strain relief

Strain relief plate

**Item no.: 2092-1602/002-000**

Gripping plate with sliding connector release; for female and male connectors; 2 parts; Pin spacing 5 mm; light gray

www.wago.com/2092-1602/002-000

Testing and measuring

Testing accessories

**Item no.: 735-500**

WAGO Test pin; 1 mm Ø; 30 V AC / 60 V DC; CAT0; 1 A; 6 mm uninsulated; Test lead for soldering up to 0,5mm²

www.wago.com/735-500

Tool

Operating tool

**Item no.: 2092-1630**

Unlocking tool; orange

www.wago.com/2092-1630

**Item no.: 210-719**

Operating tool; Blade: 2.5 x 0.4 mm; with a partially insulated shaft

www.wago.com/210-719

Downloads

Documentation

Additional Information

Technical Section

2019 Apr 3

pdf
2.0 MB

Download

Technical explanations

Subject to changes. Please also observe the further product documentation!

WAGO GmbH & Co. KG

Hansastr. 27

32423 Minden

Phone: +49571 887-0 | Fax: +49571 887-169

Email: info.de@wago.com | Web: www.wago.com

Do you have any questions about our products?

We are always happy to take your call at +49 (571) 887-44222.

CAD/CAE-Data

CAD data

| | | |
|------------------------|---------------------|--------------------------|
| 2D/3D Models 2092-1125 | URL | Download |
|------------------------|---------------------|--------------------------|

CAE data

| | | |
|------------------------|---------------------|--------------------------|
| ZUKEN Portal 2092-1125 | URL | Download |
|------------------------|---------------------|--------------------------|

Environmental Product Compliance

Compliance Search

| | | |
|--|---------------------|--------------------------|
| Environmental Product Compliance 2092-1125 | URL | Download |
|--|---------------------|--------------------------|

1-conductor female connector; push-button; Push-in CAGE CLAMP®; 2.5 mm²; Pin spacing 5 mm; 5-pole; 2,50 mm²; light gray

Installation Notes

Locking system

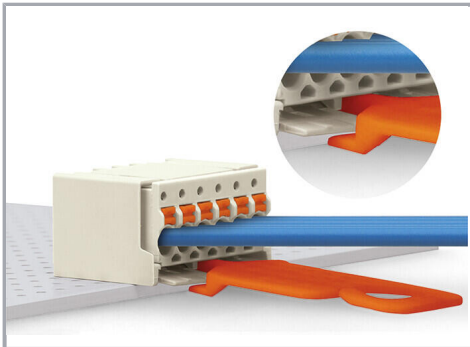

Disconnecting a female connector via unlocking tool. Plug unlocking tool into the male header's locking latch.

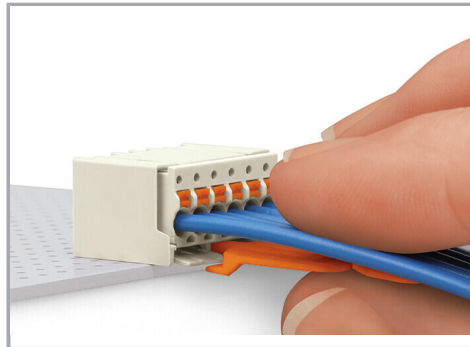

Insert unlocking tool until it hits the backstop. Wedge opens locking latches.

Subject to changes. Please also observe the further product documentation!

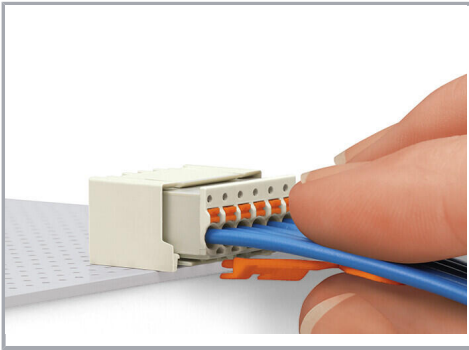

Pull on both unlocking tool and conductors to remove female connector from male header.

Conductor termination

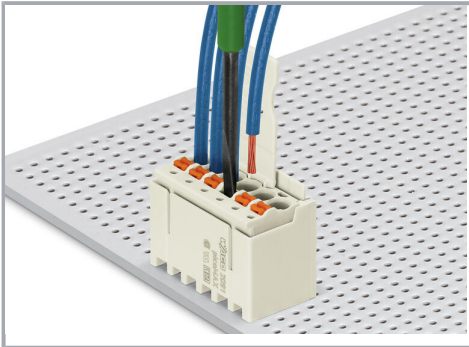

Inserting fine-stranded conductor into mated female connector via push-button.

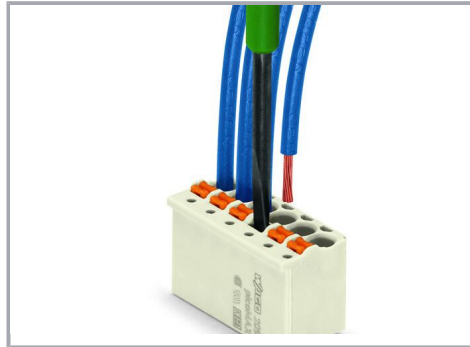

Inserting a fine-stranded conductor into an unmated female connector via push-button.

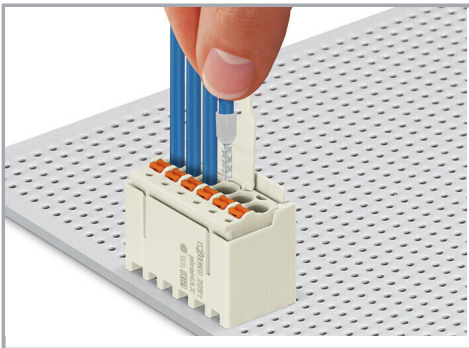

Inserting solid and ferruled conductors via push-in termination.

Marking

Subject to changes. Please also observe the further product documentation!



Pole marking via factory direct marking.

Coding

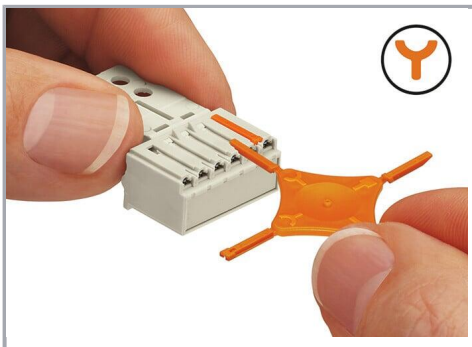

Coding a female connector (via coding key carrier and two keys for female connector, see symbol).

Testing

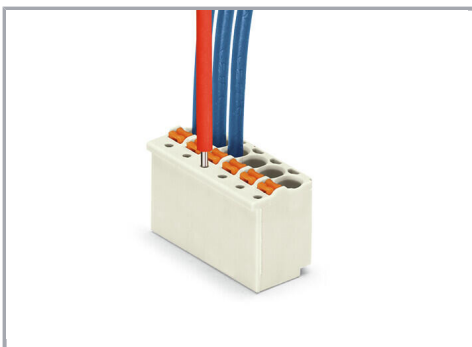

Testing via 1 mm Ø test pin – touch contact.

Subject to changes. Please also observe the further product documentation!