

ASSEMBLY INSTRUCTIONS:

1. PREPARE CABLE ENDS, CONNECT TO CONNECTOR
2. IF THE JACKSCREWS ARE NOT IN PLACE, DO NOT PUSH THEM IN, SCREW THEM INTO THE CONNECTOR
3. SELECT THE CABLE ENTRY PORT NEEDED, PLACE THE SLOT BLOCKING TABS IN THE OTHER TWO POSITIONS MAKING SURE THEY ARE FULLY SEATED
4. PLACE CABLE IN SELECTED STRAIN RELIEF RECESS AREA MAKING SURE CABLE JACKET IS BELOW STRAIN RELIEF. ENSURE THE CABLE IS PRESSED INTO THE STRAIN RELIEF RECESS AREA
5. PLACE CABLE CLAMP OVER CABLE. USING SCREWS PROVIDED, TIGHTEN CABLE CLAMP. CABLE CLAMP MAY BE INSTALLED UP SIDE DOWN FOR SMALLER CABLES
6. PLACE THE OTHER HALF OF THE HOOD ON TOP OF THE FIRST HALF, MAKING SURE NO WIRES ARE PINCHED
7. TIGHTEN THE TWO HALVES TOGETHER WITH THE SCREWS PROVIDED

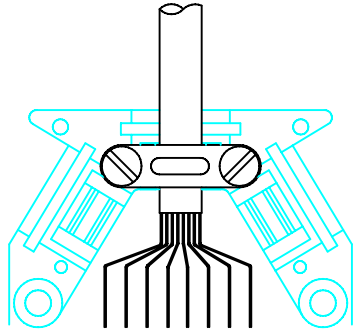
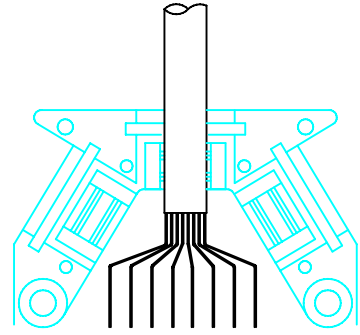
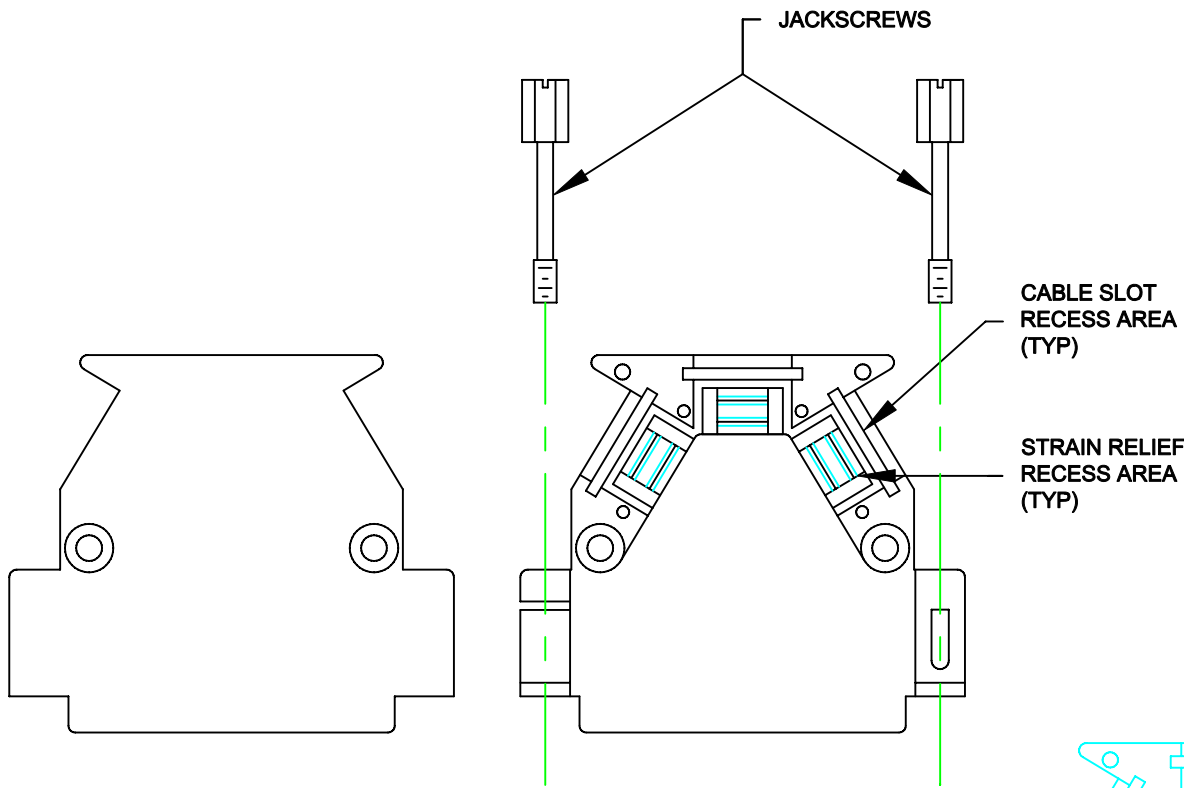

ITEM No. 4

ITEM No. 5

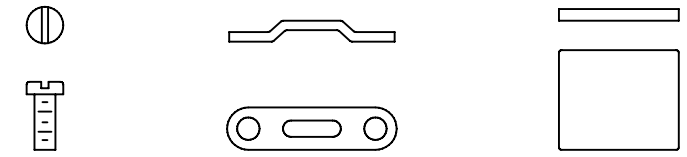

STRAIN RELIEF SCREW

STRAIN RELIEF CLAMP

CABLE SLOT BLOCK TAB

RoHS COMPLIANT

PLASTIC

	THESE DRAWINGS AND SPECIFICATIONS ARE THE PROPERTY OF NorComp AND SHALL NOT BE REPRODUCED, COPIED OR USED AS THE BASIS FOR THE MANUFACTURE OF SALE OF APPARATUS WITHOUT WRITTEN PERMISSION.		DRAWN: C. SMITH	DATE: 03-27-06
			CHECKED: X	DATE: X
NorComp		SCALE: N.T.S.	SHEET 1	OF 2
		REV 0		
		DWG NO. BACKSHELL - 975 SERIES		

ASSEMBLY INSTRUCTIONS:

1. PREPARE CABLE ENDS, CONNECT TO CONNECTOR
2. IF THE JACKSCREWS ARE NOT IN PLACE, DO NOT PUSH THEM IN, SCREW THEM INTO THE CONNECTOR
3. SELECT THE CABLE ENTRY PORT NEEDED, PLACE THE SLOT BLOCKING TABS IN THE OTHER TWO POSITIONS MAKING SURE THEY ARE FULLY SEATED
4. PLACE CABLE IN SELECTED STRAIN RELIEF RECESS AREA MAKING SURE CABLE JACKET IS BELOW STRAIN RELIEF. ENSURE THE CABLE IS PRESSED INTO THE STRAIN RELIEF RECESS AREA
5. IF CABLE IS SHIELDED, FOLD SHIELD AND/OR GROUND WIRE BACK OVER THE CLAMP AREA. CUT ANY EXCESS WIRE SO IT WILL NOT STICK OUT OF THE HOOD
6. PLACE CABLE CLAMP OVER CABLE. USING SCREWS PROVIDED, TIGHTEN CABLE CLAMP. CABLE CLAMP MAY BE INSTALLED UP SIDE DOWN FOR SMALLER CABLES
7. PLACE THE OTHER HALVE OF THE HOOD ON TOP OF THE FIRST HALF, MAKING SURE NO WIRES ARE PINCHED
8. TIGHTEN THE TWO HALVES TOGETHER WITH THE SCREWS PROVIDED

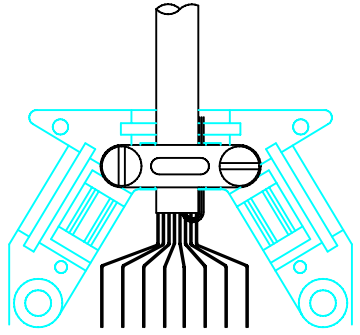
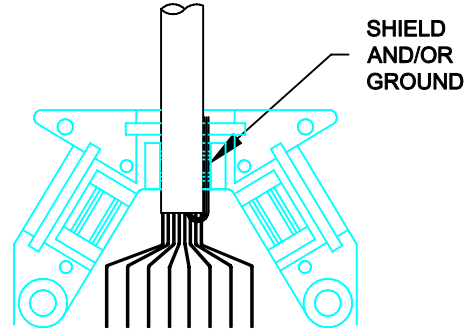
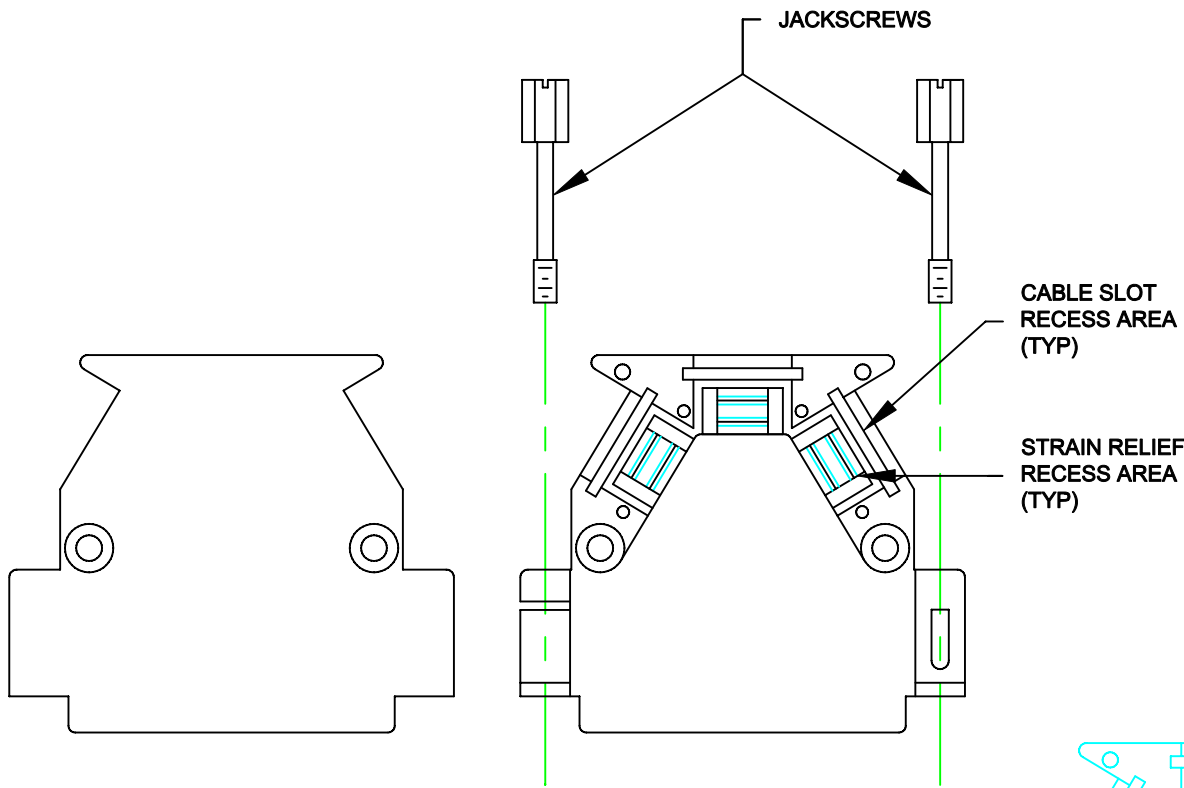

ITEM No. 4 & 5

ITEM No. 6

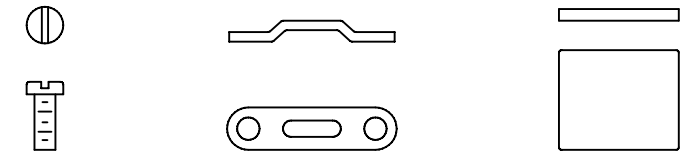

STRAIN RELIEF SCREW

STRAIN RELIEF CLAMP

CABLE SLOT BLOCK TAB

RoHS COMPLIANT

METALIZED PLASTIC

	THESE DRAWINGS AND SPECIFICATIONS ARE THE PROPERTY OF NorComp AND SHALL NOT BE REPRODUCED, COPIED OR USED AS THE BASIS FOR THE MANUFACTURE OF SALE OF APPARATUS WITHOUT WRITTEN PERMISSION.		DRAWN: C. SMITH	DATE: 03-27-06
			CHECKED: X	DATE: X
<h1>NorComp</h1>		SCALE: N.T.S.	SHEET 2 OF 2	REV 0
		DWG NO. BACKSHELL - 975 SERIES		