

## Main

Range of Product	Telemecanique Limit switches XC Standard
Series name	Standard format
Product or Component Type	Limit switch
Device short name	XCKJ
Sensor design	Form B CENELEC EN 50041
Body type	Plug-in body
Head type	Plunger head
Material	Metal
Body Material	Zamak
Head material	Zamak
Fixing Mode	By the body
Movement of operating head	Linear
Type of operator	Spring return plunger metal
Type of approach	Vertical approach, 1 direction
Cable entry	1 entry tapped for Pg 13.5 cable gland 0.35...0.47 in (9...12 mm)
Number of poles	1
Contacts type and composition	1 C/O
Contact operation	Snap action

## Complementary

Switch actuation	On end
Electrical connection	Screw-clamp terminals 1 x 0.75...2 x 1.5 mm <sup>2</sup>
Contacts insulation form	Zb
Number of steps	1
Positive opening	Without
Minimum force for tripping	20 N
Maximum actuation speed	1.64 ft/s (0.5 m/s)
Repeat accuracy	0.1 mm on the tripping points with 1 million operating cycles
[Ie] rated operational current	3 A 240 V, AC-15, A300 EN/IEC 60947-5-1 appendix A 0.27 A 250 V, DC-13, Q300 EN/IEC 60947-5-1 appendix A
[Ithe] conventional enclosed thermal current	10 A
[Ui] rated insulation voltage	300 VUL 508 500 V 3)IEC 60947-1 300 VCSA C22.2 No 14
Maximum resistance across terminals	25 MOhm IEC 60255-7 category 3
[Uimp] rated impulse withstand voltage	6 KV IEC 60664 6 kV IEC 60947-1
Short-circuit protection	10 A cartridge fuse gG
Electrical durability	5000000 Cycles, DC-13, inductive, 120 V, 4 W 60 cyc/mn 0.5 IEC 60947-5-1 appendix C 5000000 Cycles, DC-13, inductive, 24 V, 10 W 60 cyc/mn 0.5 IEC 60947-5-1 appendix C 5000000 cycles, DC-13, inductive, 48 V, 7 W 60 cyc/mn 0.5 IEC 60947-5-1 appendix C
Mechanical durability	30000000 cycles
Width	1.69 in (43 mm)

The information provided in this documentation contains general descriptions and/or technical characteristics of the performance of the products contained herein. This documentation is not intended as a substitute for and is not to be used for determining suitability or reliability of these products for specific user applications. It is the duty of any such user or integrator to perform the appropriate and complete risk analysis, evaluation and testing of the products with respect to the relevant specific application or use thereof. Neither Schneider Electric Industries SAS nor any of its affiliates or subsidiaries shall be responsible or liable for misuse of the information contained herein.

Height	3.31 in (84 mm)
Depth	1.42 in (36 mm)
Net Weight	0.95 lb(US) (0.43 kg)
Terminals description ISO n°1	(11-12)NC (13-14)NO

## Environment

Shock resistance	50 gn 11 ms IEC 60068-2-27
Vibration resistance	25 gn 10...500 Hz)IEC 60068-2-6
IP degree of protection	IP66 conforming to IEC 60529
IK degree of protection	IK07 EN 50102
Overvoltage category	Class I IEC 61140 Class I NF C 20-030
Ambient Air Temperature for Operation	-13...158 °F (-25...70 °C)
Ambient Air Temperature for Storage	-40...158 °F (-40...70 °C)
Protective treatment	TH
Product Certifications	CCC UL CSA
Standards	IEC 60947-5-1 CSA C22.2 No 14 EN 60204-1 CENELEC EN 50041 UL 508 EN 60947-5-1 IEC 60204-1



## Ordering and shipping details

Category	22411-LIMIT SWITCHES,IEC,XCKJ
Discount Schedule	T
GTIN	3389110645828
Nbr. of units in pkg.	1
Package weight(Lbs)	16.38 oz (464.5 g)
Returnability	No
Country of origin	FR

## Packing Units

Unit Type of Package 1	PCE
Package 1 Height	1.69 in (4.3 cm)
Package 1 width	2.68 in (6.8 cm)
Package 1 Length	5.04 in (12.8 cm)
Unit Type of Package 2	CAR
Number of Units in Package 2	1
Package 2 Weight	16.26 oz (461.0 g)
Package 2 Height	1.69 in (4.3 cm)
Package 2 width	2.68 in (6.8 cm)
Package 2 Length	5.04 in (12.8 cm)

## Offer Sustainability

Sustainable offer status	Green Premium product
California proposition 65	WARNING: This product can expose you to chemicals including: Diisononyl phthalate (DINP), which is known to the State of California to cause cancer, and Di-isodecyl phthalate (DIDP), which is known to the State of California to cause birth defects or other reproductive harm. For more information go to <a href="http://www.P65Warnings.ca.gov">www.P65Warnings.ca.gov</a>
REACH Regulation	 <a href="#">REACH Declaration</a>
EU RoHS Directive	Pro-active compliance (Product out of EU RoHS legal scope)  <a href="#">EU RoHS Declaration</a>
Mercury free	Yes

---

RoHS exemption information	 Yes
Environmental Disclosure	 Product Environmental Profile

---

**Contractual warranty**

---

Warranty	18 months
----------	-----------

---

Dimensions

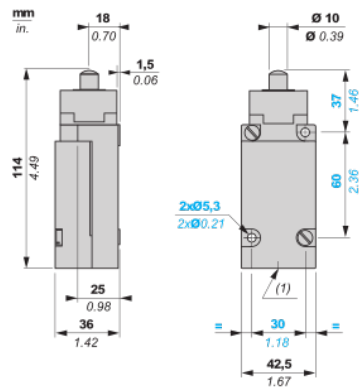

(1) 1 tapped entry Pg 13.5

---

## Mounting with Cable Entry

---

### Position of Cable Gland

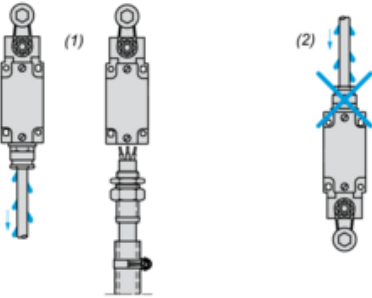

(1) Recommended

(2) To be avoided

---

## Wiring Diagram

---

### Single-pole CO Snap Action

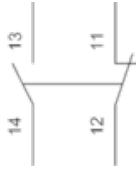

---

Characteristics of Actuation

---

Switch Actuation on End

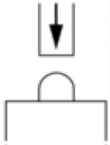

---

Functionnal Diagram

---

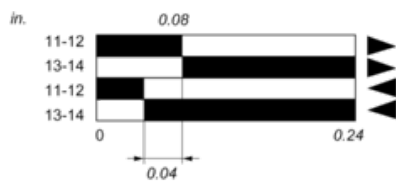
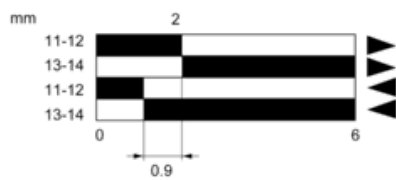

- (1)
- (2)
- ▶ (3)
- ◀ (4)

- (1) Closed
- (2) Open
- (3) Tripping
- (4) Resetting