

ENVISIONING • EMPOWERING • EXCELLING



**XR79206**  
**40V, 6A Synchronous Step**  
**Down COT Power Module**  
EVB User Manual

## Document Revision History

Document No.	Release Date	Change Description
1A	4/25/16	Initial release of document.
012UMR00	7/8/19	Complete re-write. Updated to MaxLinear format.

## Table of Contents

<b>Introduction</b> .....	<b>1</b>
Quick EVB Set Up and Start Up.....	1
Factory Settings .....	1
Quick Start Up .....	1
<b>Reference Documentation</b> .....	<b>2</b>
<b>Ordering Information</b> .....	<b>2</b>
<b>Evaluation Board Overview</b> .....	<b>3</b>
<b>I/O Test Points</b> .....	<b>3</b>
EN input.....	3
PGOOD output .....	3
FB and SS monitoring .....	3
<b>Set-Up Options</b> .....	<b>4</b>
Jumper J1.....	4
V <sub>OUT</sub> Selection .....	4
<b>XR79206EVB Schematic</b> .....	<b>5</b>
<b>XR79206EVB PCB Layers</b> .....	<b>6</b>
<b>XR79206EVB Bill of Materials</b> .....	<b>8</b>

## List of Figures

Figure 1: Monitoring $V_{IN}$ and $V_{OUT}$ .....	1
Figure 2: Top View of XR79206EVB, REV2.0.....	2
Figure 3: Block Diagram, XR79206EVB.....	3
Figure 4: J1 Jumper in Forced CCM Mode .....	4
Figure 5: J1 Jumper in DCM / CCM Mode .....	4
Figure 6: XR79206EVB Schematic .....	5
Figure 7: Assembly Top.....	6
Figure 8: Assembly Bottom .....	6
Figure 9: Top Layer .....	6
Figure 10: Bottom Layer.....	6
Figure 11: Layer 2 .....	7
Figure 12: Layer 3 .....	7
Figure 13: Layer 4 .....	7
Figure 14: Layer 5 .....	7

## List of Tables

Table 1: Evaluation Board Ordering Part Number .....	2
Table 2: Factory Settings.....	4
Table 3: Jumper J1 Options.....	4
Table 4: XR79206EVB Bill of Materials .....	8

## Introduction

The XR79206 evaluation board provides a platform to evaluate the features and performance of the XR79206 Synchronous Step Down COT Power Module. The XR79206 provides a maximum load current rating of 6A with a 5V to 40V input voltage range and is packaged in a 10mm x 10mm x 4mm QFN.

## Quick EVB Set Up and Start Up

### Factory Settings

In addition to utilizing the 5V to 40V input voltage range and 6A maximum load current rating of the Synchronous Step Down COT Power Module, each Evaluation Board has been set up with the factory default configurations shown below for quick set up and operation. **Do not exceed the EVB maximum load current rating.**

- $V_{IN}$  = 24V typical.
- $V_{OUT}$  = 3.3V. For a different  $V_{OUT}$  selection, see [V<sub>OUT</sub> Selection](#).
- 500kHz Switching Frequency.
- Forced CCM mode. For DCM / CCM mode, see [Jumper J1](#).
- Soft start time = 2.82ms.
- PGOOD is pulled up.

### Quick Start Up

To quickly see the regulator in operation:

1. Use the factory settings and default configuration. If other settings or components are desired, apply them before the next steps and see [Set-Up Options](#) for more.
2. Connect a turned-off power supply that is within the  $V_{IN}$  specification (5V to 40V, 24V typical) to  $V_{IN+}$  and  $V_{IN-}$  with short / thick leads. Use test pins T3 and T4 to monitor  $V_{IN+}$  and  $V_{IN-}$  respectively. See locations in [Figure 1](#) Note A.
3. Initially set to 0A, connect an electronic load that will be no more than the maximum  $I_{OUT}$  (6A) to  $V_{OUT+}$  and  $V_{OUT-}$  with short / thick leads. Use test pins T1 and T2 to monitor  $V_{OUT+}$  and  $V_{OUT-}$  respectively. See locations in [Figure 1](#) Note B.
4. Turn on the power supply and check  $V_{OUT}$ . The EVB should power up and regulate the output at 3.3V (factory default).
5. Set or vary the load (do not exceed the maximum  $I_{OUT}$ ) and check  $V_{OUT}$  and other desired performance levels such as regulation and efficiency. See [I/O Test Points](#) for more on monitoring.

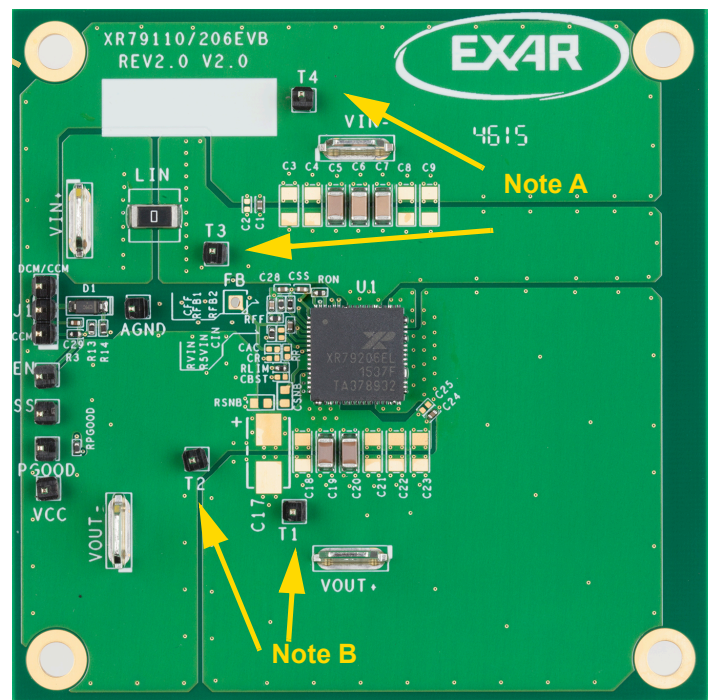

**Figure 1: Monitoring  $V_{IN}$  and  $V_{OUT}$**

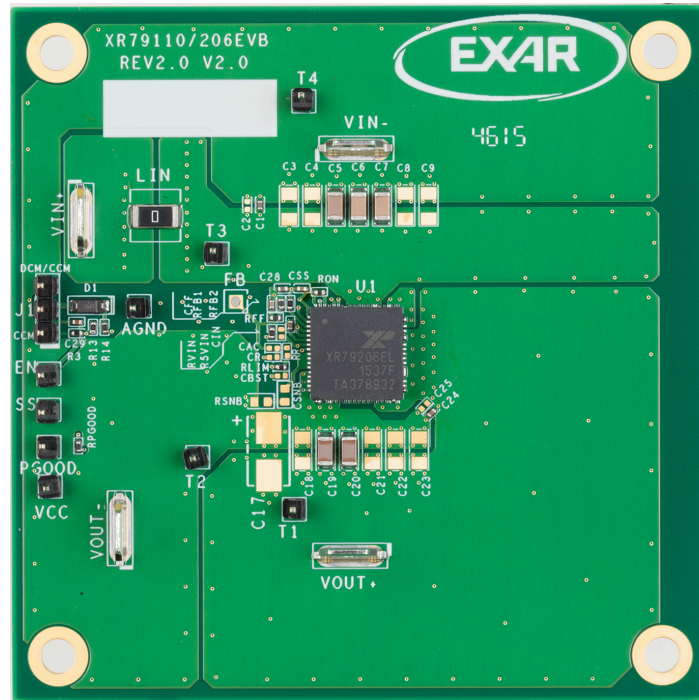

**Figure 2: Top View of XR79206EVB, REV2.0**

## Reference Documentation

Please refer to the [XR79206 Data Sheet](#) for additional information, including a full list of IC features, pinout, pin descriptions, typical performance characteristics and external component calculations. This manual is meant to be used in conjunction with the datasheet. Refer to [ANP-47](#) for EMI considerations.

This manual provides EVB schematics ([XR79206EVB Schematic](#)), PCB Layout ([XR79206EVB PCB Layers](#)) and bill of materials ([XR79206EVB Bill of Materials](#)) that can be utilized to assist in your design. The schematics are also available on the power module's product page.

## Ordering Information

**Table 1: Evaluation Board Ordering Part Number<sup>(1)</sup>**

Power Module	Evaluation Board	IC Current Rating	Board Description
<a href="#">XR79206</a>	XR79206EVB	6A	<a href="#">XR79206</a> Evaluation Board

1. Refer to [www.maxlinear.com/XR79206](http://www.maxlinear.com/XR79206) for most up-to-date Ordering Information.

## Evaluation Board Overview

The block diagram shown in [Figure 3](#) illustrates the connection points for the VIN and VOUT pins, location of the J1 DCM/CCM jumper and monitoring I/O test points for the XR79206EVB.

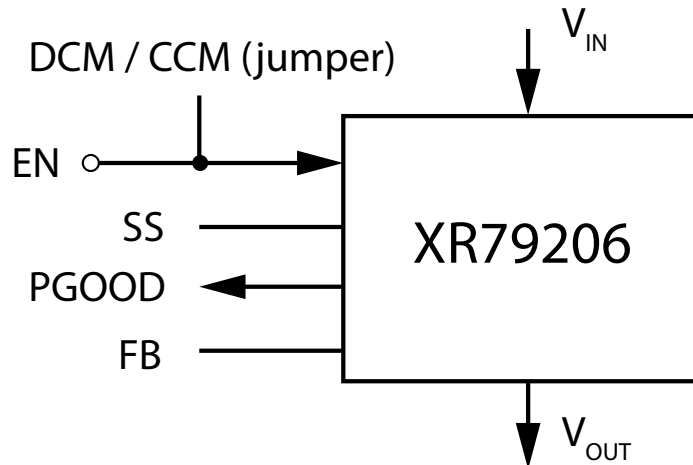

**Figure 3: Block Diagram, XR79206EVB**

## I/O Test Points

### EN input

The EN input can be used to monitor the voltage on the EN/MODE pin. On board circuitry provides voltage to the EN pin.

### PGOOD output

The PGOOD output can be used to monitor the IC's PGOOD open drain output. It is tied to VCC through a 10k $\Omega$  resistor. VCC also has a test point that can be monitored. The PGOOD output can be used externally.

### FB and SS monitoring

A test point is provided for the FB and SS signals of the IC. The test points are also called FB and SS, respectively. A 47nF capacitor is factory installed on each board for  $C_{SS}$ . Using this capacitor value and the datasheet equation, this calculates into a soft-start time of 2.82ms.



## Set-Up Options

A jumper is factory installed per [Table 2](#) to configure the EVB for operation. Jumper options are next described. Refer to the [XR79206](#) product datasheet for additional information.

**Table 2: Factory Settings**

Jumper	Factory Setting	Description
J1	Jumper 1-2	Forced CCM

## Jumper J1

**Table 3: Jumper J1 Options**

Jumper Options	Description	Position
Jumper 1-2	Forced CCM mode (factory setting).	<a href="#">Figure 4</a>
Jumper 2-3	DCM / CCM mode. The regulator will operate in DCM at light load.	<a href="#">Figure 5</a>

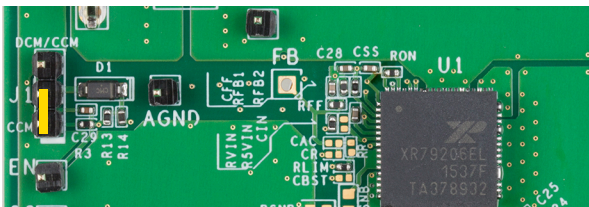

**Figure 4: J1 Jumper in Forced CCM Mode**

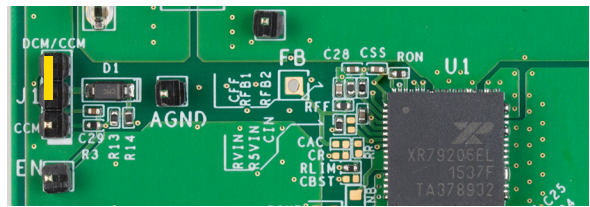

**Figure 5: J1 Jumper in DCM / CCM Mode**

## V<sub>OUT</sub> Selection

The factory installed configuration of V<sub>OUT</sub> is 3.3V. The V<sub>OUT</sub> can be modified by changing RFB1 according to:

$$RFB1 = RFB2 \times \left( \frac{V_{OUT}}{0.6} - 1 \right)$$

Where RFB2 has a nominal value of 2kΩ.

As explained in the datasheet, R<sub>ON</sub> must be set correspondingly in order to get the desired frequency.

# XR79206EVB Schematic

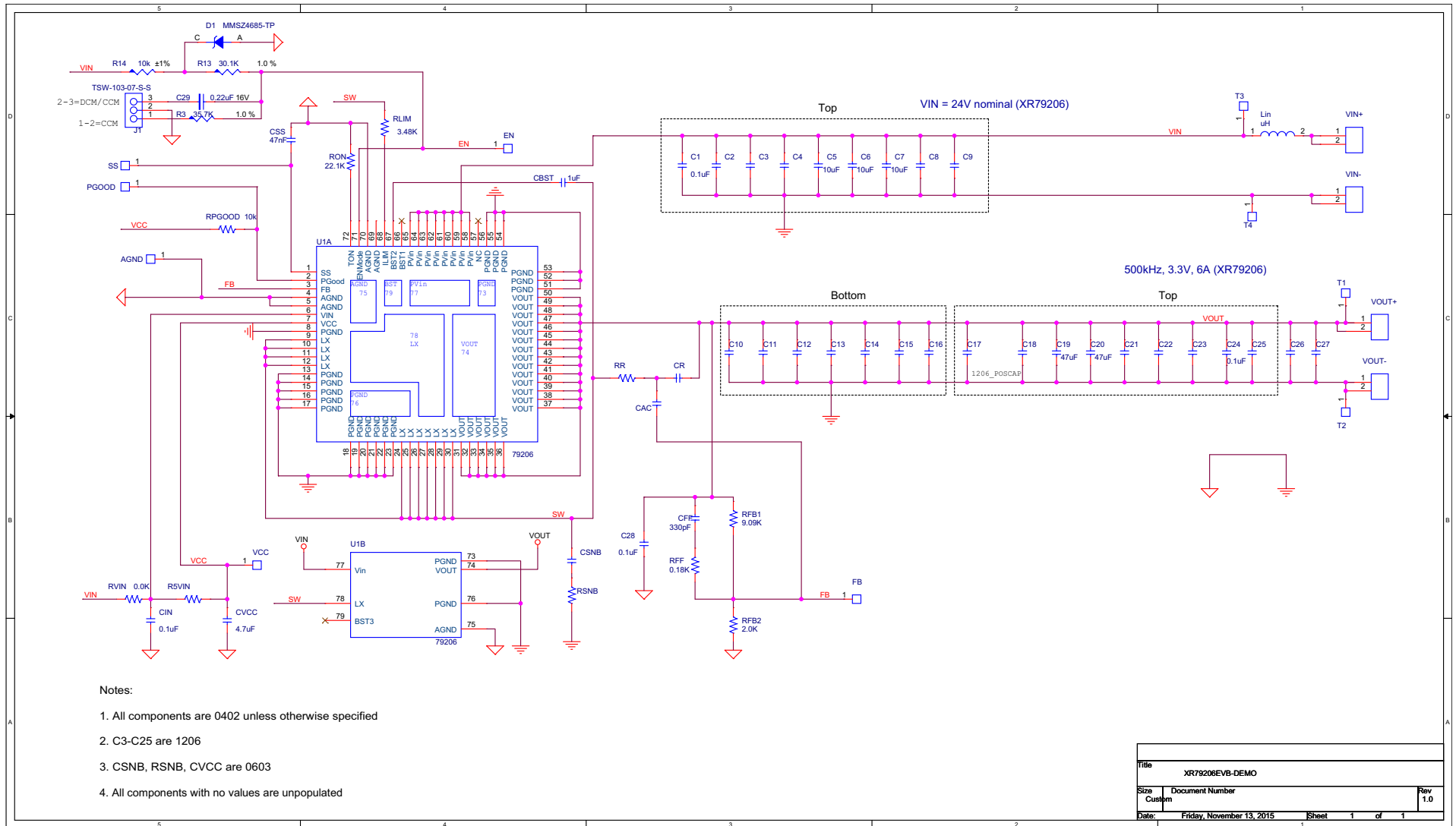

Figure 6: XR79206EV B Schematic

# XR79206EVB PCB Layers

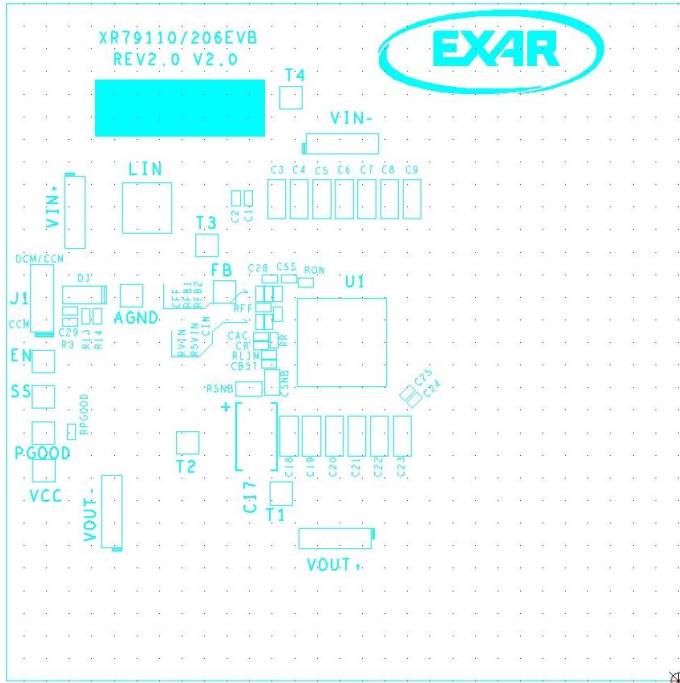

Figure 7: Assembly Top

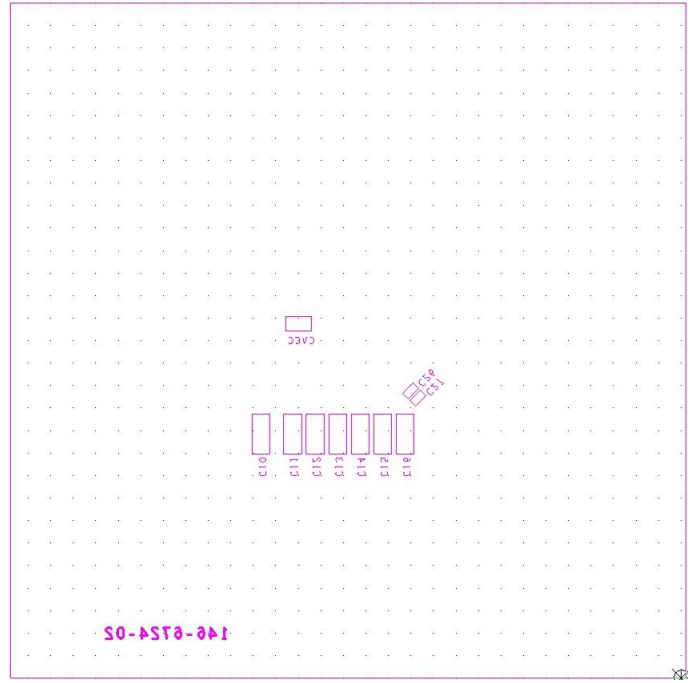

Figure 8: Assembly Bottom

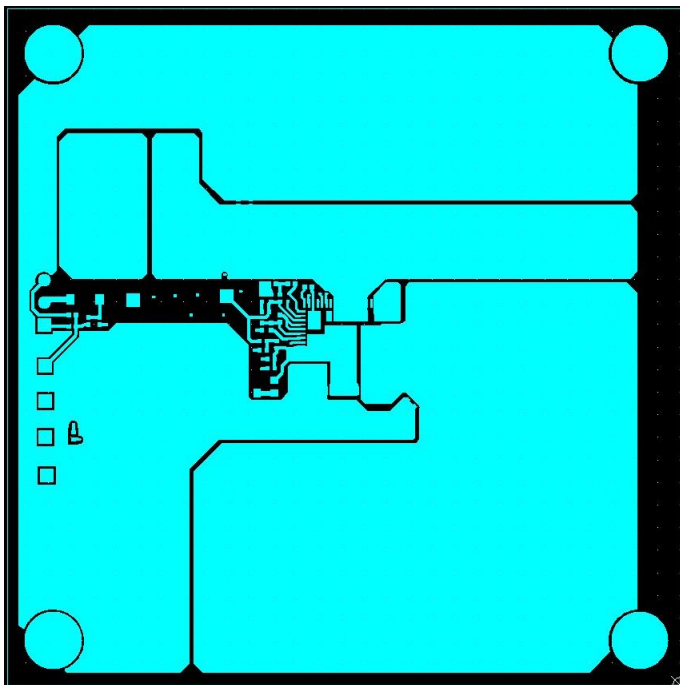

Figure 9: Top Layer

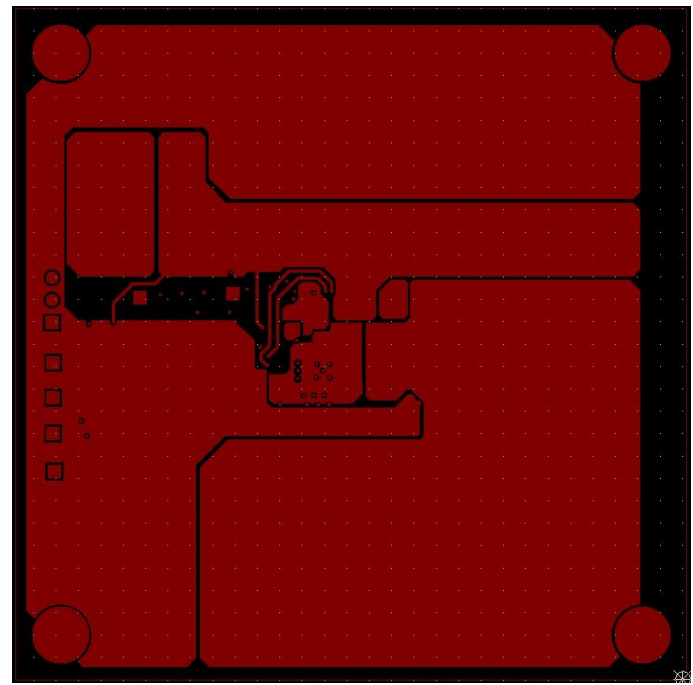

Figure 10: Bottom Layer

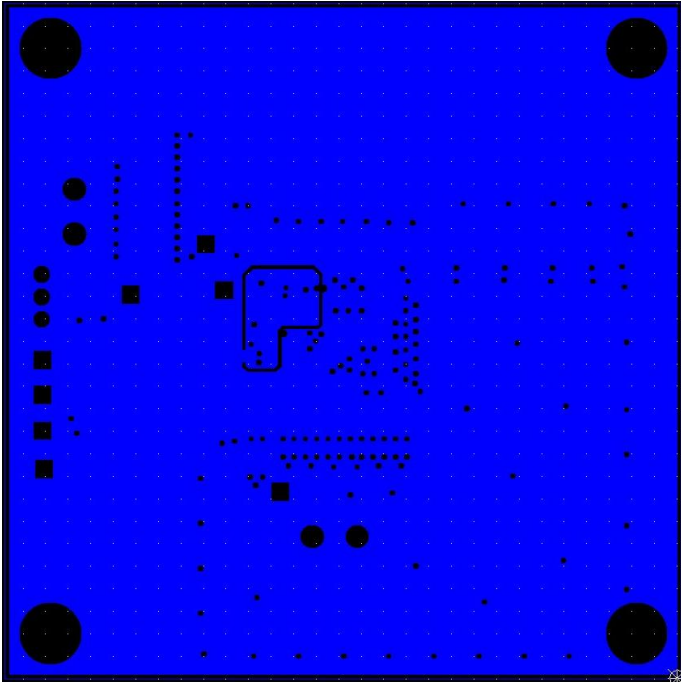

Figure 11: Layer 2

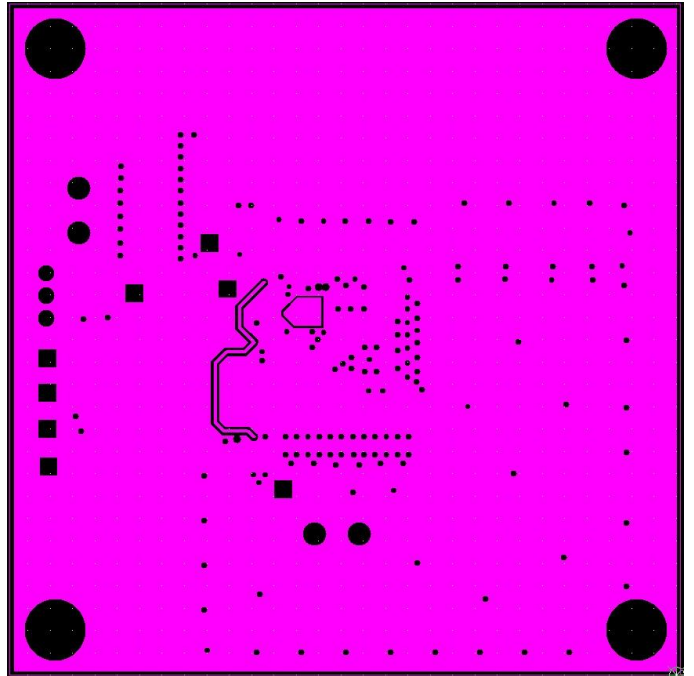

Figure 12: Layer 3

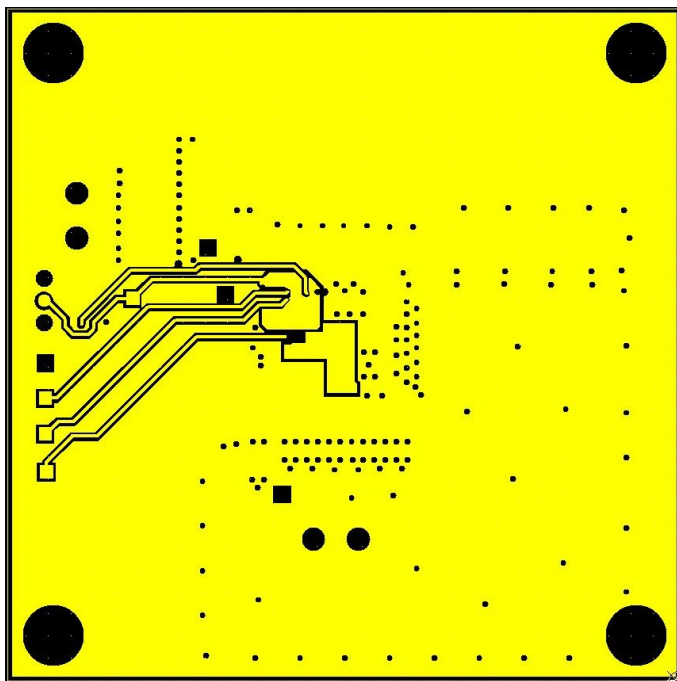

Figure 13: Layer 4

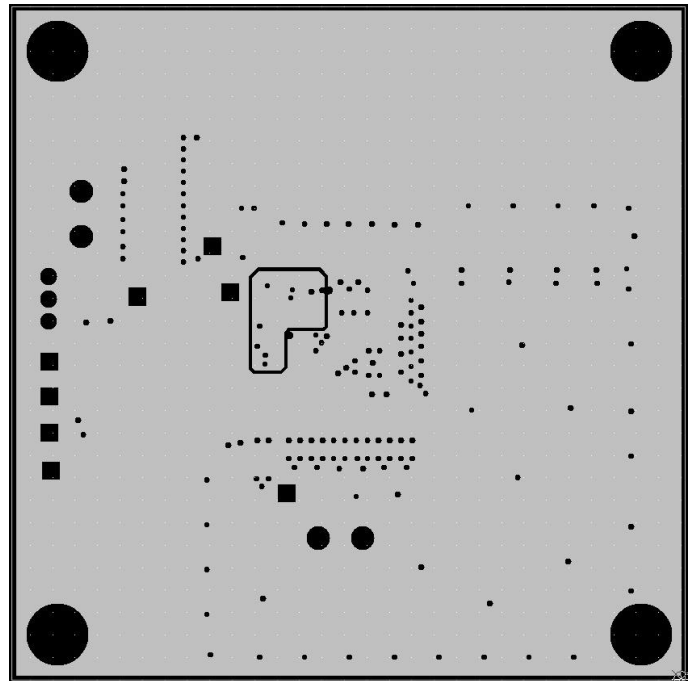

Figure 14: Layer 5

## XR79206EVB Bill of Materials

**Table 4: XR79206EVB Bill of Materials**

Item	Qty	Reference Designator	Component	Manufacturer / Part Number	Package Size
1	1	PCB	XR79206 Evaluation Board	MaxLinear	
2	1	U1	XR79206	MaxLinear	10mm x 10mm
3	1	D1	Diode Zener 3.6V, 500mW, SOD123	ON Semi MMSZ4685T1G	SOD-123
4	3	C5, C6, C7	CERAMIC CAP. 10 $\mu$ F, 50V, X5R, 10%	Murata GRM31CR61H106KA12L	1206
5	2	C19, C20	CERAMIC CAP. 47 $\mu$ F, 10V, X5R, 10%	Murata GRM31CR61A476KE15L	1206
6	4	C1N, C1, C24, C28	CERAMIC CAP. 0.1 $\mu$ F, 50V, X7R, 10%	Murata GRM155R71H104KE14D	0402
7	1	CVCC	CERAMIC CER. 4.7 $\mu$ F, 10V, X5R, 10%	Murata GRM188R61A475KE15D	0603
8	1	C29	CERAMIC CAP. 0.22 $\mu$ F, 16V, X7R, 10%	Murata GRM155R71C224KA12D	0402
9	1	CSS	CERAMIC CAP. 47nF, 50V, X7R, 10%	Murata GRM155R71H473KE14D	0402
10	1	CFF	CERAMIC CAP. 330pF, 50V, X7R, 10%	Murata GRM155R71H331KA01D	0402
11	1	R3	Resistor 35.7k $\Omega$ , 1/10W, 1%, SMD	Panasonic ERJ-2RKF3572X	0402
12	1	RFB1	Resistor 9.09k $\Omega$ , 1/10W, 1%, SMD	Panasonic ERJ-2RKF9091X	0402
13	1	RFB2	Resistor 2.0k $\Omega$ , 1/10W, 1%, SMD	Panasonic ERJ-2RKF2001X	0402
14	1	RVIN	Resistor 0.0 $\Omega$ , Jumper, 1/10W, SMD	Panasonic ERJ-2GE0R00X	0402
15	2	RPGOOD, R14	Resistor 10.0k $\Omega$ , 1/10W, 1%, SMD	Panasonic ERJ-2RKF1002X	0402
16	1	R13	Resistor 30.1k $\Omega$ , 1/10W, 1%, SMD	Panasonic ERJ-2RKF3012X	0402
17	1	RLIM	Resistor 3.48k $\Omega$ , 1/10W, 1%, SMD	Panasonic ERJ-2RKF3481X	0402
18	1	RFF	Resistor 180 $\Omega$ , 1/10W, 1%, SMD	Panasonic ERJ-2RKF1801X	0402
19	1	RON	Resistor 22.1k $\Omega$ , 1/10W, 1%, SMD	Panasonic ERJ-2RKF2212X	0402
20	1	LIN	Resistor 0.0 $\Omega$ , Jumper, 3/4W, SMD	Vishay / Dale CRCW12100000Z0EAHP	2010
21	10	T1, T2, T3, T4, VCC, PGOOD, SS, EN, AGND, FB	Header 1 pin	Würth Elektronik 6130011121	2.54mm
22	1	J1	Header 3 pin	Würth Elektronik 6130031121	2.54mm
23	4	VIN+, VOUT+, VIN-, VOUT-	Mounting Tab WA-MTAB	Würth Elektronik 7471287	
24	1	J1 - Jumper	Header Jumper	Würth Elektronik 60900213421	2.54mm



MaxLinear, Inc.  
5966 La Place Court, Suite 100  
Carlsbad, CA 92008  
760.692.0711 p.  
760.444.8598 f.  
[www.maxlinear.com](http://www.maxlinear.com)

The content of this document is furnished for informational use only, is subject to change without notice, and should not be construed as a commitment by MaxLinear, Inc. MaxLinear, Inc. assumes no responsibility or liability for any errors or inaccuracies that may appear in the informational content contained in this guide. Complying with all applicable copyright laws is the responsibility of the user. Without limiting the rights under copyright, no part of this document may be reproduced into, stored in, or introduced into a retrieval system, or transmitted in any form or by any means (electronic, mechanical, photocopying, recording, or otherwise), or for any purpose, without the express written permission of MaxLinear, Inc.

MaxLinear, Inc. does not recommend the use of any of its products in life support applications where the failure or malfunction of the product can reasonably be expected to cause failure of the life support system or to significantly affect its safety or effectiveness. Products are not authorized for use in such applications unless MaxLinear, Inc. receives, in writing, assurances to its satisfaction that: (a) the risk of injury or damage has been minimized; (b) the user assumes all such risks; (c) potential liability of MaxLinear, Inc. is adequately protected under the circumstances.

MaxLinear, Inc. may have patents, patent applications, trademarks, copyrights, or other intellectual property rights covering subject matter in this document. Except as expressly provided in any written license agreement from MaxLinear, Inc., the furnishing of this document does not give you any license to these patents, trademarks, copyrights, or other intellectual property.

MaxLinear, the MaxLinear logo, and any MaxLinear trademarks, MxL, Full-Spectrum Capture, FSC, G.now, AirPHY and the MaxLinear logo are all on the products sold, are all trademarks of MaxLinear, Inc. or one of MaxLinear's subsidiaries in the U.S.A. and other countries. All rights reserved. Other company trademarks and product names appearing herein are the property of their respective owners.