

Sensor/actuator cable - SAC-HZ-3P-10,0-542/FSSHSCO BK - 1409498

Please be informed that the data shown in this PDF Document is generated from our Online Catalog. Please find the complete data in the user's documentation. Our General Terms of Use for Downloads are valid (<http://phoenixcontact.com/download>)



Sensor/actuator cable, 3-position, PVC, yellow, shielded, free cable end, on Socket straight M12, coding: A, cable length: 10 m



Key Commercial Data

| | |
|------------------------|---|
| Packing unit | 1 pc |
| Minimum order quantity | 10 pc |
| GTIN |  4 055626 017624 |
| GTIN | 4055626017624 |

Technical data

Dimensions

| | |
|-----------------|------|
| Length of cable | 10 m |
|-----------------|------|

Ambient conditions

| | |
|---------------------------------|----------------------------------|
| Ambient temperature (operation) | -25 °C ... 90 °C (Plug / socket) |
| | -25 °C ... 90 °C (Plug / socket) |
| Degree of protection | IP65 |
| | IP67 |

General

| | |
|-----------------------|---|
| Note | These cable assemblies are UL/cUL listed for use in Class I, Division 2 (CID2) hazardous locations. |
| Rated current at 40°C | 4 A |
| Rated voltage | 48 V AC 60 V DC |
| Number of positions | 3 |
| Insulation resistance | ≥ 100 MΩ |
| Coding | A - standard |
| Standards/regulations | M12 connector IEC 61076-2-101 |

Sensor/actuator cable - SAC-HZ-3P-10,0-542/FSSHSCO BK - 1409498

Technical data

General

| | |
|------------------------------|------------------------|
| Status display | No |
| Protective circuit/component | unwired |
| Degree of pollution | 3 |
| Insertion/withdrawal cycles | ≥ 100 |
| Torque | 0.4 Nm (M12 connector) |

Material

| | |
|--|---|
| Flammability rating according to UL 94 | HB |
| Contact material | CuSn |
| Contact surface material | Ni/Au |
| Contact carrier material | TPU GF |
| Material of grip body | TPU, hardly inflammable, self-extinguishing |
| Material, knurls | Zinc die-cast, nickel-plated |
| Sealing material | NBR |

Standards and Regulations

| | |
|--|------------------------------------|
| Standards/specifications | M12 connector IEC 61076-2-101 |
| Flammability rating according to UL 94 | HB |
| UL, USA/Canada | Class I, Div. 2, Groups A, B, C, D |

Cable

| | |
|---|------------------------------|
| Cable type | PVC yellow 105 °C |
| Cable type (abbreviation) | 542 |
| UL AWM style | 2517 (105 °C / 300 V) |
| AWG signal line | 22 |
| Conductor structure signal line | 30x 1.30 mm |
| Core diameter including insulation | 1.27 mm ±0.03 mm |
| Wire colors | brown, blue, black |
| Overall twist | 3 wires, twisted |
| Shielding | Tinned copper braided shield |
| Optical shield covering | 85 % |
| External sheath, color | yellow |
| External cable diameter D | 5.2 mm ±0.2 mm |
| Minimum bending radius, flexible installation | 12 x D |
| Cable weight | 40 kg/km |
| Outer sheath, material | PVC |
| Material conductor insulation | PVC |
| Conductor material | Tin-plated Cu litz wires |
| Insulation resistance | ≥ (550 M Ohms/m @ 500V) |
| Conductor resistance | max. 50.5 Ω/km (20 °C) |
| Nominal voltage, cable | 300 V |
| Special properties | UL standards PLTC and ITC |

Sensor/actuator cable - SAC-HZ-3P-10,0-542/FSSHSCO BK - 1409498

Technical data

Cable

| | |
|---------------------------------|---|
| Other resistance | UV resistant |
| Flame resistance | FT4 |
| Ambient temperature (operation) | -30 °C ... 105 °C (cable, fixed installation) |
| | -5 °C ... 105 °C (cable, flexible installation) |

Environmental Product Compliance

| | |
|------------|---|
| China RoHS | Environmentally Friendly Use Period = 50 years |
| | For details about hazardous substances go to tab "Downloads", Category "Manufacturer's declaration" |

Drawings

Schematic diagram

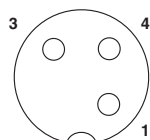

Pin assignment M12 socket, 3-pos., A-coded, view female side

Cable cross section

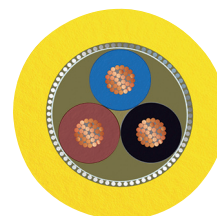

PVC yellow 105 °C [542]

Dimensional drawing

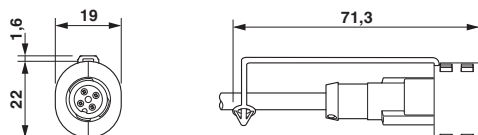

EXCLIP mounted plug

Circuit diagram

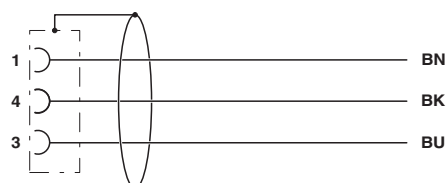

Contact assignment of the M12 socket

Sensor/actuator cable - SAC-HZ-3P-10,0-542/FSSHSCO BK - 1409498

Dimensional drawing

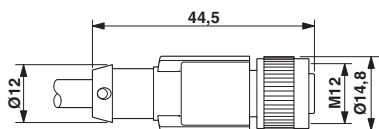

M12 x 1 socket, straight, shielded

Dimensional drawing

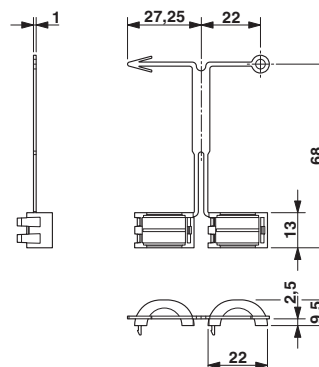

EXCLIP socket

Classifications

eCl@ss

| | |
|---------------|----------|
| eCl@ss 10.0.1 | 27060311 |
| eCl@ss 11.0 | 27060311 |
| eCl@ss 4.0 | 27060300 |
| eCl@ss 4.1 | 27060300 |
| eCl@ss 5.0 | 27061800 |
| eCl@ss 5.1 | 27061800 |
| eCl@ss 6.0 | 27279200 |
| eCl@ss 7.0 | 27279218 |
| eCl@ss 9.0 | 27060311 |

ETIM

| | |
|----------|----------|
| ETIM 4.0 | EC001855 |
| ETIM 6.0 | EC001855 |
| ETIM 7.0 | EC001855 |

UNSPSC

| | |
|-------------|----------|
| UNSPSC 13.2 | 31251501 |
| UNSPSC 19.0 | 31251501 |
| UNSPSC 20.0 | 31251501 |
| UNSPSC 21.0 | 31251501 |

Approvals

Approvals

Approvals

EAC-RoHS

Sensor/actuator cable - SAC-HZ-3P-10,0-542/FSSHSCO BK - 1409498

Approvals

Ex Approvals

UL Listed / cUL Listed / cULus Listed

Approval details

| | | |
|----------|--|--------------------------|
| EAC-RoHS | | RU D- DE.HB35.B.00387 |
|----------|--|--------------------------|

Accessories

Accessories

Plug for cable screw gland

Screw plug - PROT-M12 MS-PA-CHAIN - 1430899

M12 sealing cap with fixing band, for sensor cables, for free M12 sockets



Safety locking

Locking clip - SAC-M12-EXCLIP-F - 1558991



Locking clip for the socket side of sensor/actuator cables with M12 connector and M12 connectors for assembly, for knurl diameter: 15 mm or for Allen key with a wrench size of 14 mm, prevents the disconnection of plug-in connections without tools

Screwdriver tools

Adapter insert - TSD-M SAC-BIT ADAPTER - 1212600



Adapter bit for TSD-M...torque tools, E6.3-1/4" drive with 4 mm hexagon to accommodate SAC bits

Sensor/actuator cable - SAC-HZ-3P-10,0-542/FSSHSCO BK - 1409498

Accessories

Tool - SAC BIT M12-D15 - 1208432



Nut for assembling sensor/actuator cables with M12 connector and M12 connectors for assembly, with a knurl diameter of 15 mm, for 4 mm hexagonal drive

Torque tool

Torque screwdriver - TSD 04 SAC - 1208429



Torque screwdriver, with preset torque of 0.4 Nm and 4 mm hexagonal drive for M12 connectors

Torque screwdriver - TSD-M 1,2NM - 1212224



Torque screw driver, accuracy as per EN ISO 6789 standard, adjustable from 0.3 - 1.2 Nm

Phoenix Contact 2021 © - all rights reserved
<http://www.phoenixcontact.com>

PHOENIX CONTACT GmbH & Co. KG
Flachsmarktstr. 8
32825 Blomberg
Germany
Tel. +49 5235 300
Fax +49 5235 3 41200
<http://www.phoenixcontact.com>