

**Contact Information**

**525-P.C. Tail, High Point - Tail LG.=.190(4.83)**

**.156" (3.96mm) Contact Spacing x .200" (5.08mm) Row Spacing**

THIS IS A C.A.D. GENERATED DRAWING  
DO NOT MAKE MANUAL REVISIONS TO MASTER.



ISSUE NUMBER

ORIGINAL ①

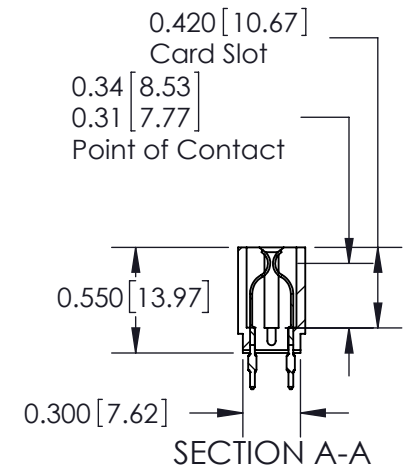
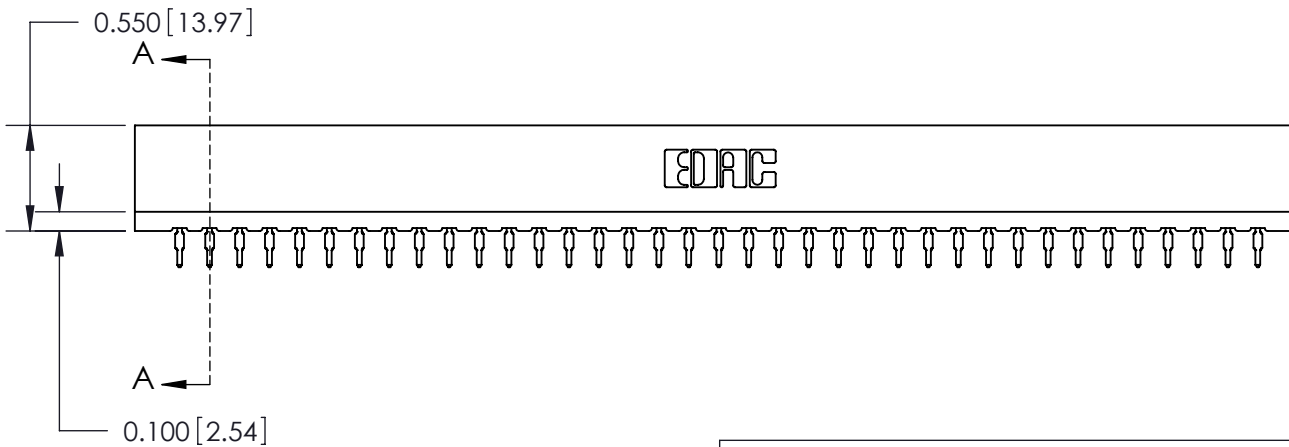
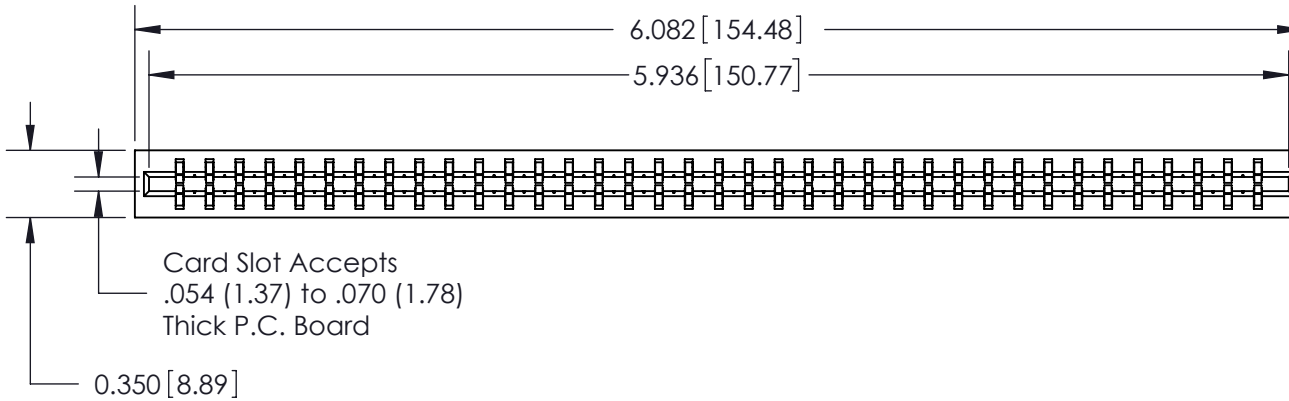

**Note:**  
**MBB switching contacts assembled in specified positions are available on request.**

717 Series Ultra-Mate Card Edge Connector - Press Fit

Part Number: 717-074-525-201



YOUR CONNECTION TO QUALITY & SERVICE

EDAC INC  
TORONTO, ONTARIO  
CANADA

THESE DRAWINGS AND SPECIFICATIONS ARE THE PROPERTY OF EDAC INC. AND SHALL NOT BE REPRODUCED, OR COPIED OR USED AS THE BASIS FOR THE MANUFACTURE OR SALE OF APPARATUS WITHOUT WRITTEN PERMISSION.

ACAD REFERENCE NO.	717-ENG MASTER	
DRAWN:	J.LEE	DATE: AUG.28/09
CHECKED:	DATE:	
SCALE:	SHEET 1 OF 1	
DRAWING NUMBER	717-ENG MASTER	ISSUE
		1