

Tri band Wi-Fi Flexible Printed Antenna (2.4/5/6 GHz)



AFG4507W2

Request Samples



Check Inventory



45.0 x 7.8 x 0.2 mm
RoHS/RoHS II Compliant
MSL Level = N/A

Features

- Compact
- High Efficiency
- High Gain
- Flexible antenna
- Easy installation using peel-and-stick.
- Fully customizable cable and connector options for RF connection

Applications

- IoT
- M2M
- Wearables
- Home Automation
- Medical Devices

Product Image



Tri band Wi-Fi Flexible Printed Antenna (2.4/5/6 GHz)



AFG4507W2

Request Samples



Check Inventory



45.0 x 7.8 x 0.2 mm
RoHS/RoHS II Compliant
 MSL Level = N/A

Part Number Builder

AFG4507W2 -

Color	
Code	Description
S (Standard)	Black

Cable length in 'mm'	
Cable length supported: Ø1.13 mm, Ø1.37 or Ø0.81 mm (30 mm to 500 mm)	
Code	Description
0200 (Standard)	200 mm
Other Examples:	
0030	30 mm
0500	500 mm

Cable Type & Connector Type		
Code	Cable Type	Connector Type
S (Standard)	Ø1.13 mm	IPEX-1 (F)
A		IPEX-4 (F)
B	Ø1.37 mm	IPEX-1 (F)
C		IPEX-4 (F)
D	Ø0.81 mm	IPEX-3 (F)

Example Configurations :

Part Number	Color	Cable length	Cable Type / Connector Type
AFG4507W2 S-0200S	Black	0200 mm	Ø1.13 mm with IPEX-1 (F) (Standard)
AFG4507W2 S-0050A	Black	0050 mm	Ø1.13 mm with IPEX-4 (F)

Note :

- For the standard part number (AFG4507W2**S-0200S**), please refer to the packaging at the end of the document.
- For custom configurations (AFG4507W2-), MOQs, pricing and packaging changes may be applicable.

Tri band Wi-Fi Flexible Printed Antenna (2.4/5/6 GHz)



AFG4507W2

Request Samples



Check Inventory



45.0 x 7.8 x 0.2 mm
RoHS/RoHS II Compliant
 MSL Level = N/A

Electrical Specification

Parameter	Specification			Unit
	Min	Typ	Max	
Operating Frequency	2400		2500	MHz
	5150		5850	
	5925		7125	
VSWR			3.0	
Peak gain	@2400 MHz	6.62		dBi
	@2450 MHz	6.01		
	@2500 MHz	6.61		
	@5160 MHz	7.68		
	@5500 MHz	8.12		
	@5840 MHz	6.91		
Impedance		50		Ω
Polarization	Linear			
Radiation Pattern	Omni-directional			

Mechanical Specification

Parameter	Specification
Antenna Dimensions	45.0 x 7.8 x 0.2 mm
Antenna Type	Flexible Printed Circuit
Mounting Type	Adhesive / Connector
RF Connector	IPEX-1 (F)
RF Cable Type	RF \varnothing 1.13 mm
Cable Length	200 \pm 10 mm

Note :

- Do not install the antenna on a metal surface.
- The antenna was tested on an ABS plastic surface of thickness 2mm. Frequency detuning may occur with change in dielectric material and thickness of the mounting surface.

Environmental Specification

Parameter	Specification
Operating Temperature	-40°C to +85°C
Storage Temperature	-40°C to +85°C
ROHS Compliant	Yes
PB Free	Yes
ESD Sensitive	No
MSL Level	N/A



5101 Hidden Creek Ln Spicewood TX 78669
 Phone: 512-371-6159 | Fax: 512-351-8858
 For terms and conditions of sales, please visit:
www.abracon.com

REVISED: 09-14-22

ABRACON IS
 ISO9001-2015
 CERTIFIED

Tri band Wi-Fi Flexible Printed Antenna (2.4/5/6 GHz)



AFG4507W2

Request Samples



Check Inventory



45.0 x 7.8 x 0.2 mm
RoHS/RoHS II Compliant
MSL Level = N/A

Product Dimension

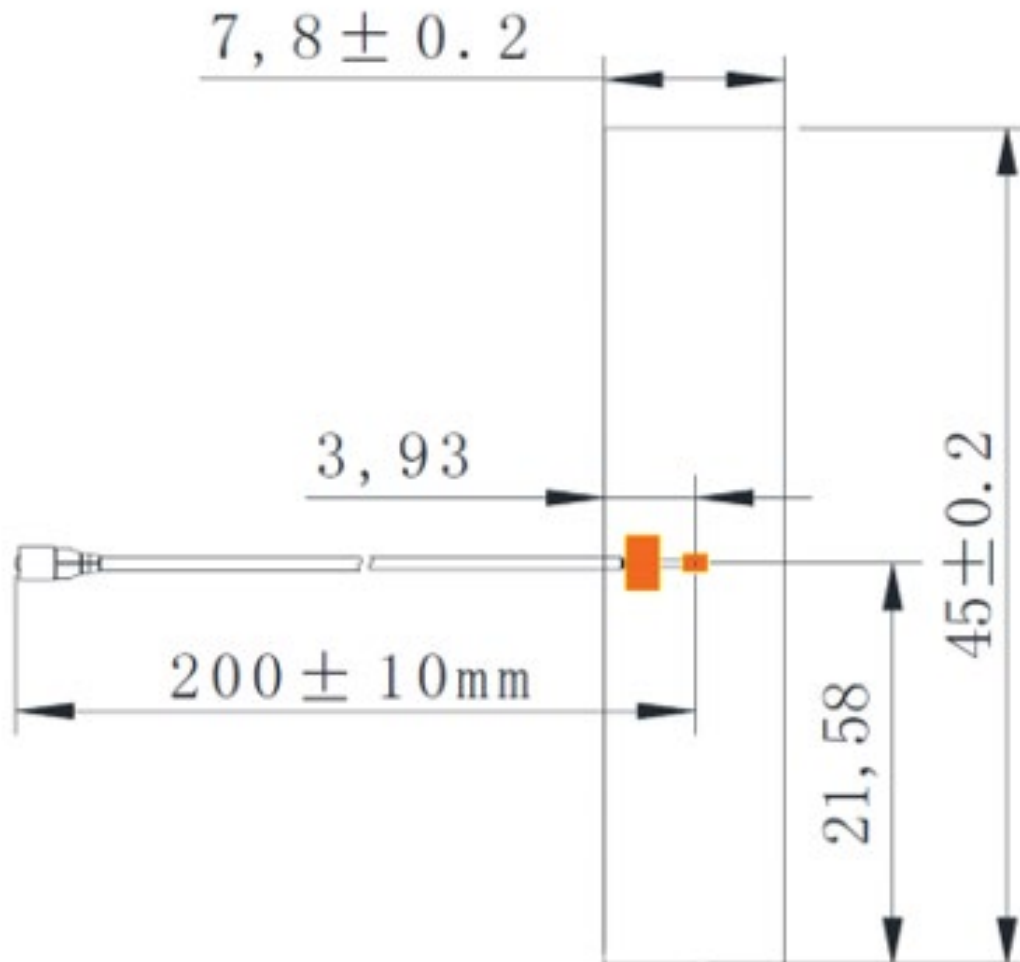

Unit : mm

Tri band Wi-Fi Flexible Printed Antenna (2.4/5/6 GHz)



AFG4507W2

Request Samples



Check Inventory



45.0 x 7.8 x 0.2 mm
RoHS/RoHS II Compliant
MSL Level = N/A

Return Loss

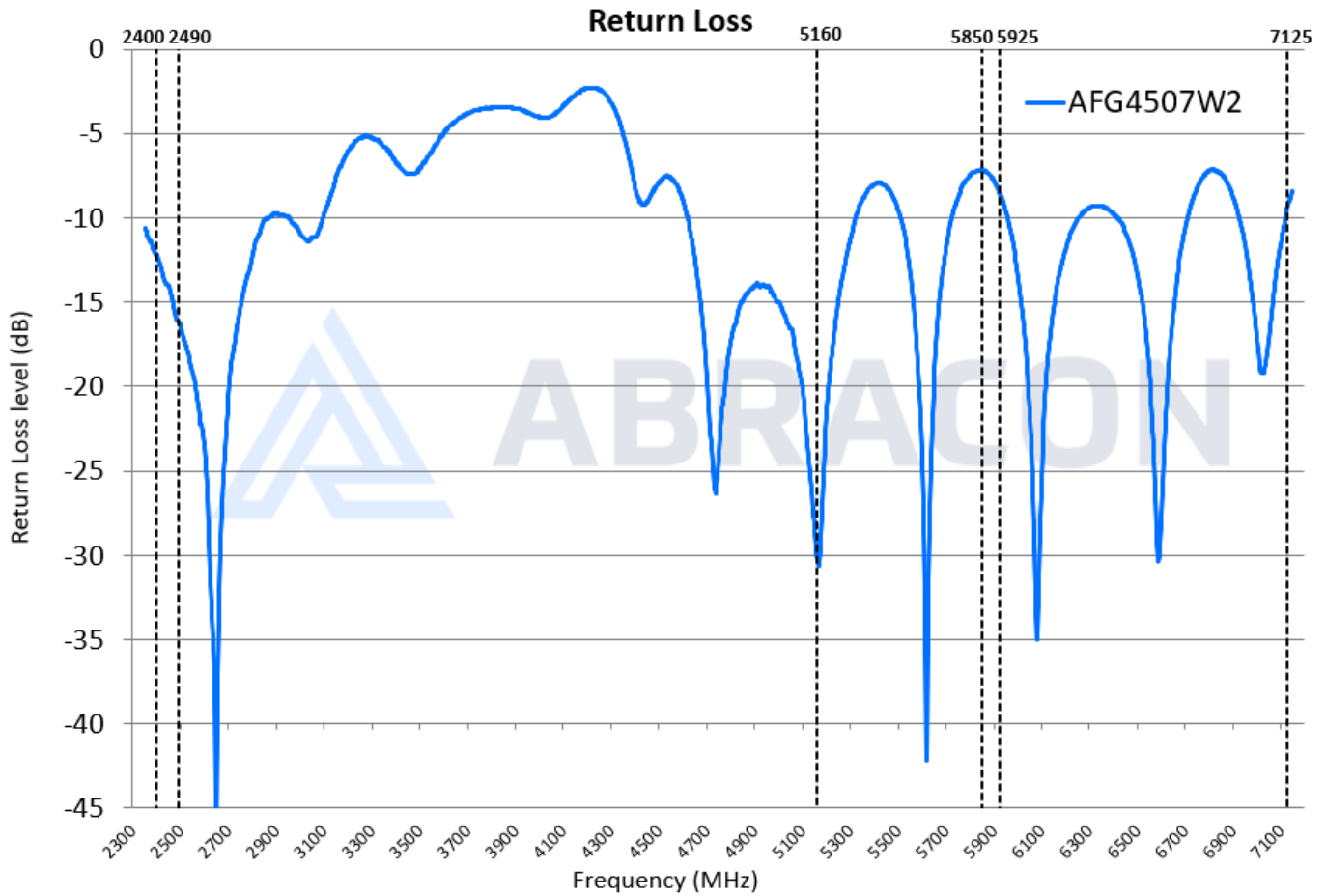

Tri band Wi-Fi Flexible Printed Antenna (2.4/5/6 GHz)



AFG4507W2

Request Samples



Check Inventory



45.0 x 7.8 x 0.2 mm
 RoHS/RoHS II Compliant
 MSL Level = N/A

Radiation Characteristics

2.40 GHz Band

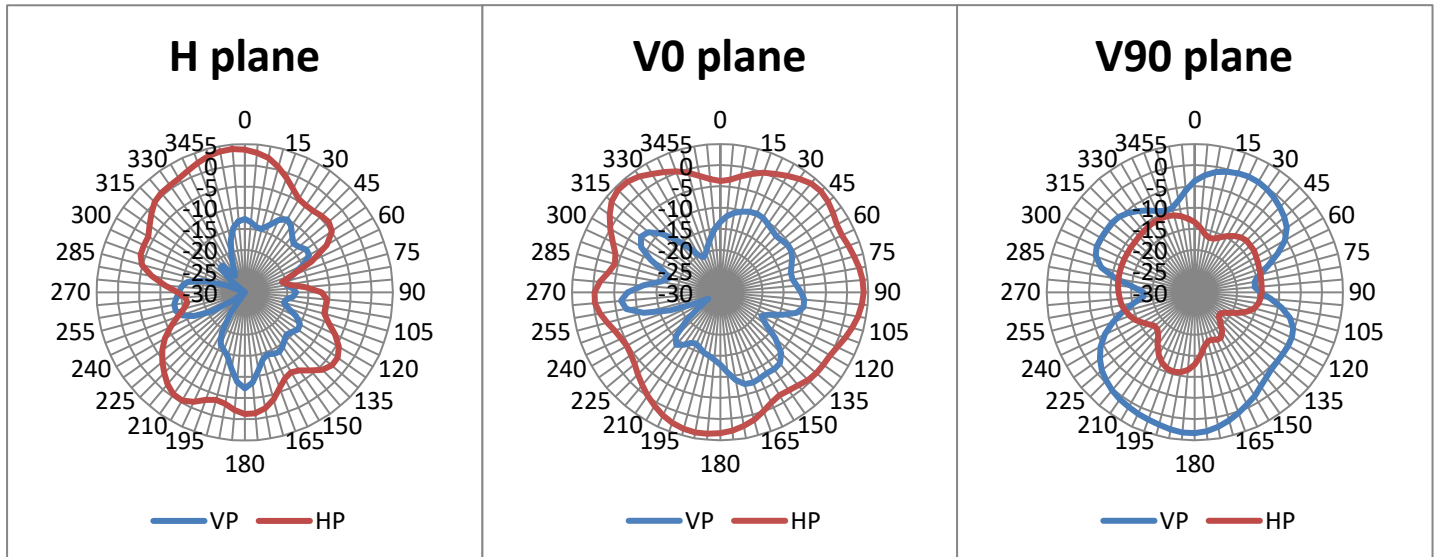

2.45 GHz Band

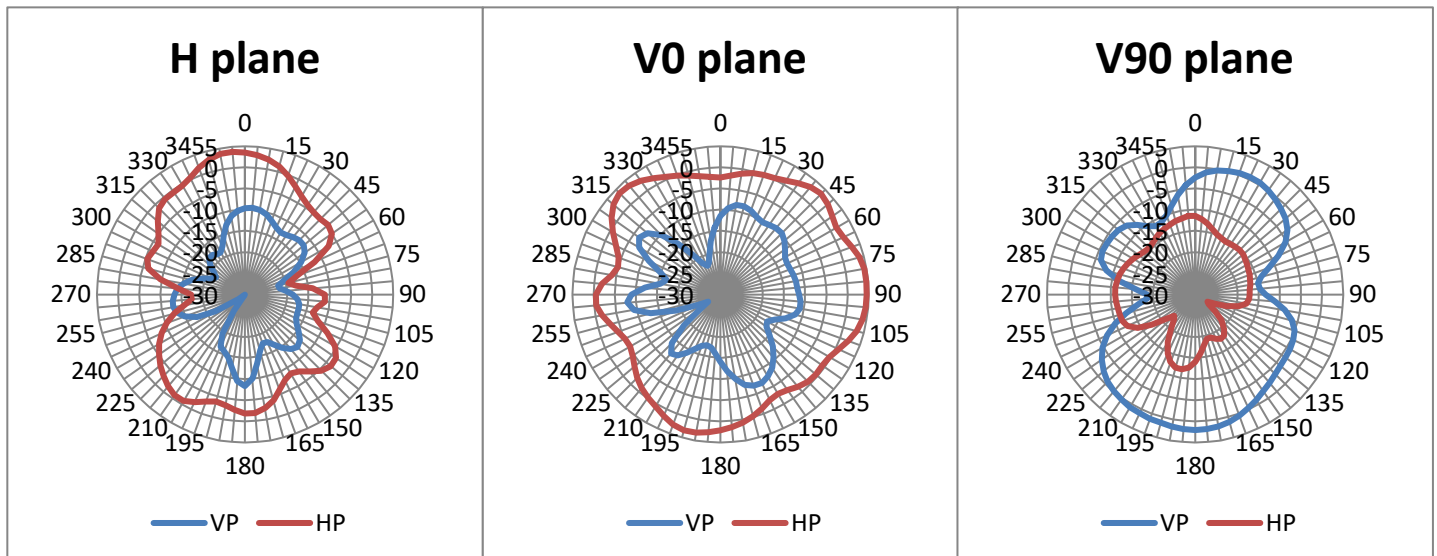

Tri band Wi-Fi Flexible Printed Antenna (2.4/5/6 GHz)



AFG4507W2

Request Samples



Check Inventory



45.0 x 7.8 x 0.2 mm
RoHS/RoHS II Compliant
MSL Level = N/A

2.49 GHz Band

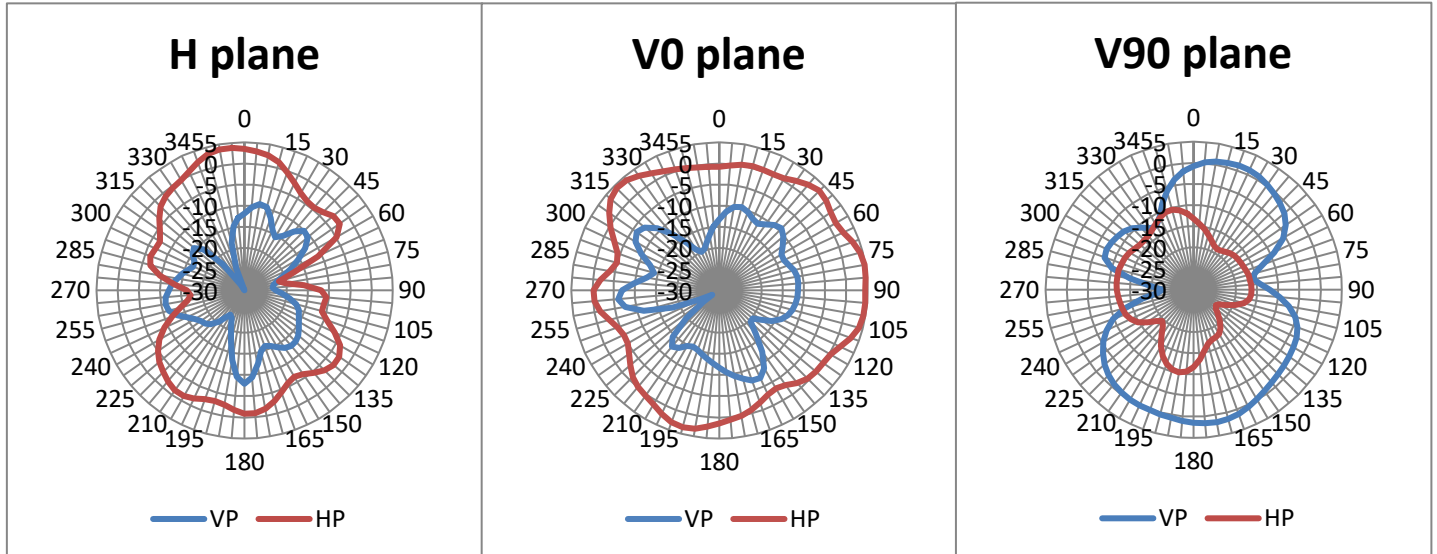

5.15 GHz Band

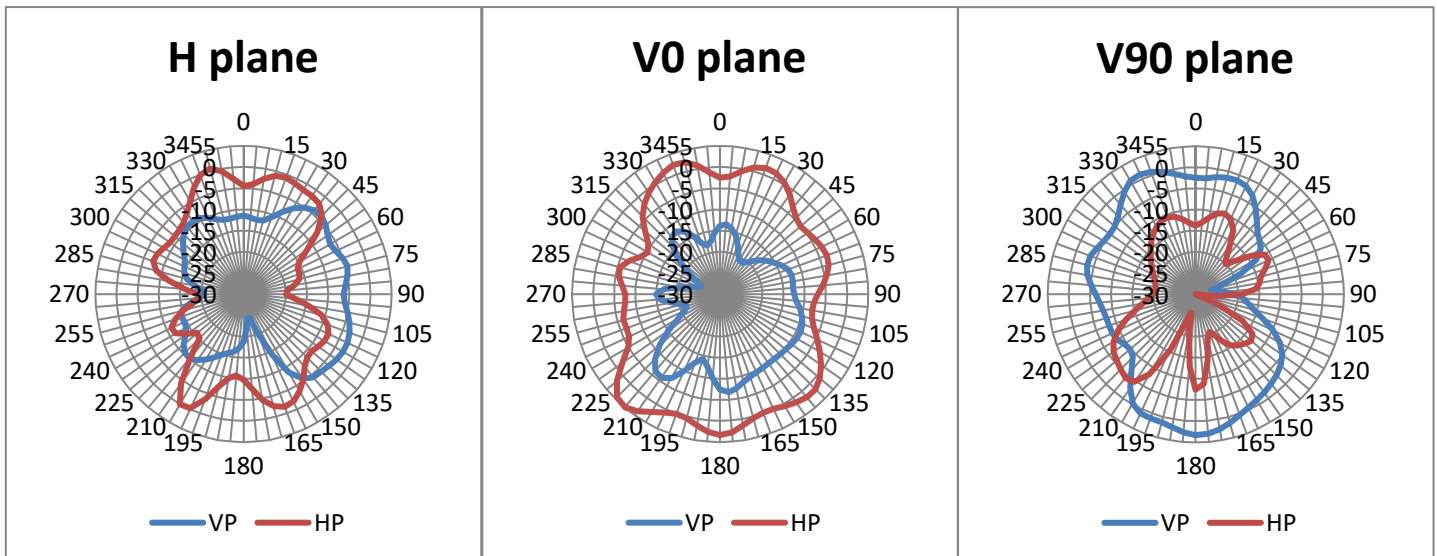

Tri band Wi-Fi Flexible Printed Antenna (2.4/5/6 GHz)



AFG4507W2

Request Samples



Check Inventory



45.0 x 7.8 x 0.2 mm
RoHS/RoHS II Compliant
 MSL Level = N/A

5.5 GHz Band

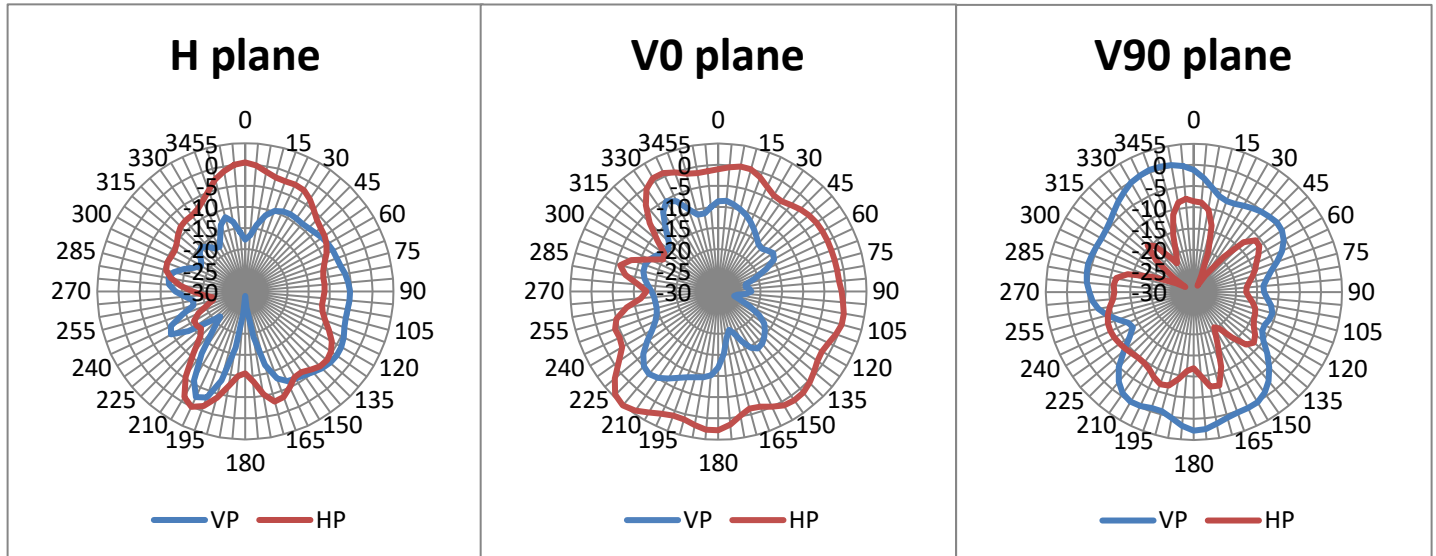

5.85 GHz Band

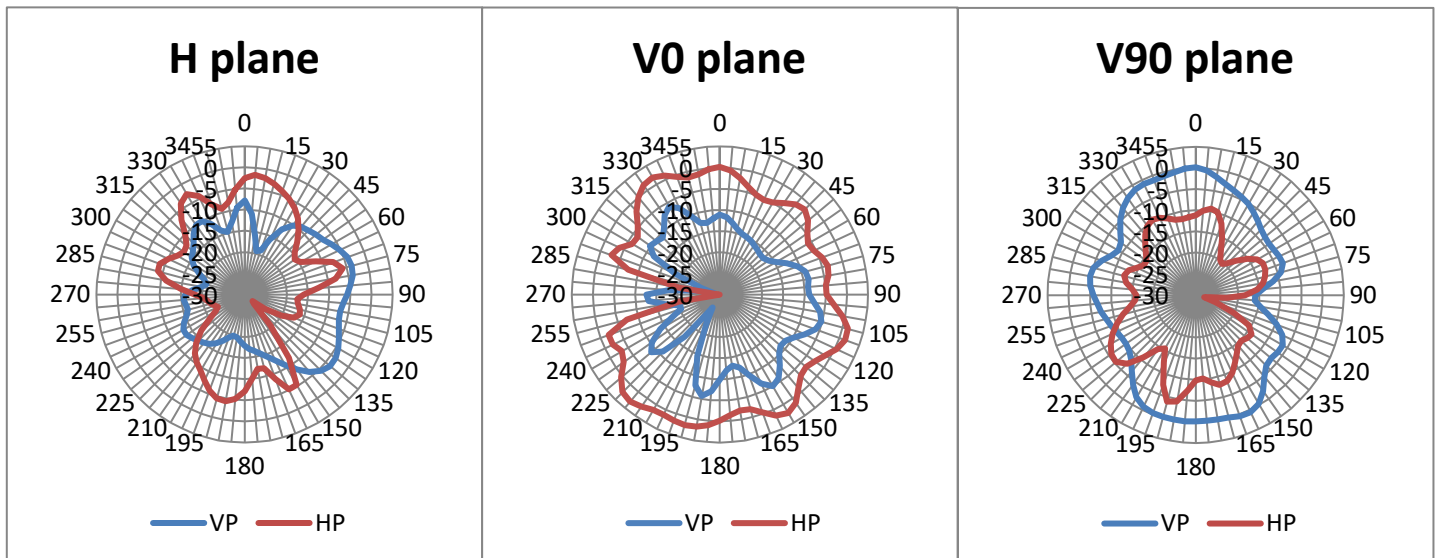

Tri band Wi-Fi Flexible Printed Antenna (2.4/5/6 GHz)



AFG4507W2

Request Samples



Check Inventory



45.0 x 7.8 x 0.2 mm
RoHS/RoHS II Compliant
MSL Level = N/A

5.925 GHz Band

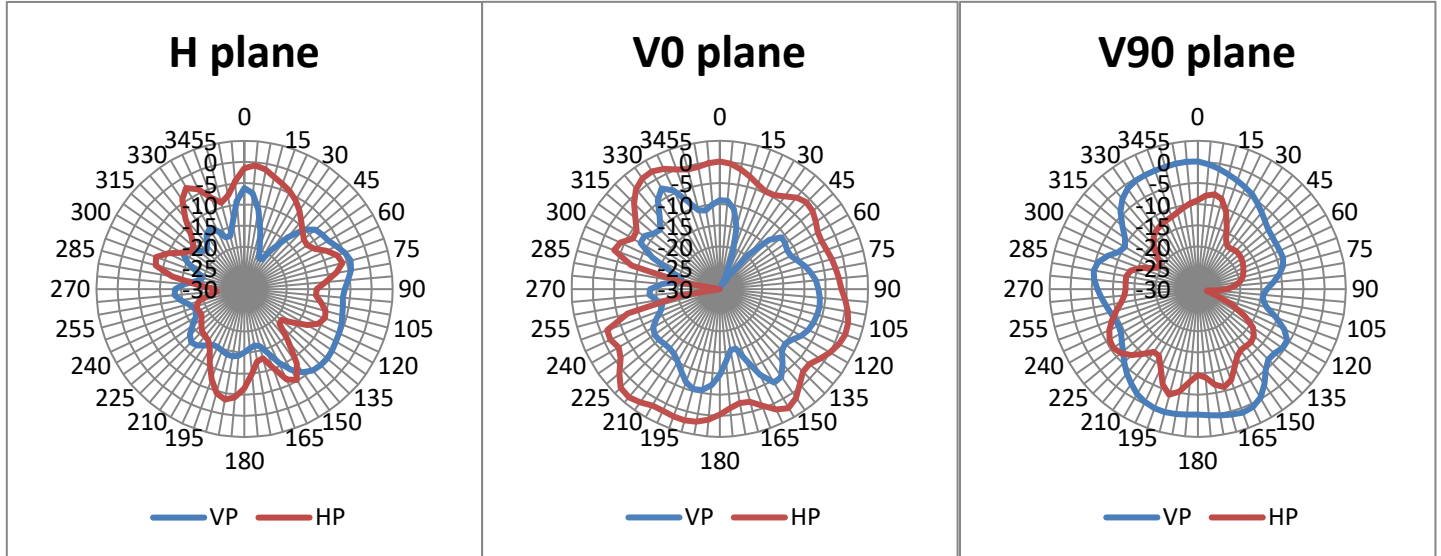

6.425 GHz Band

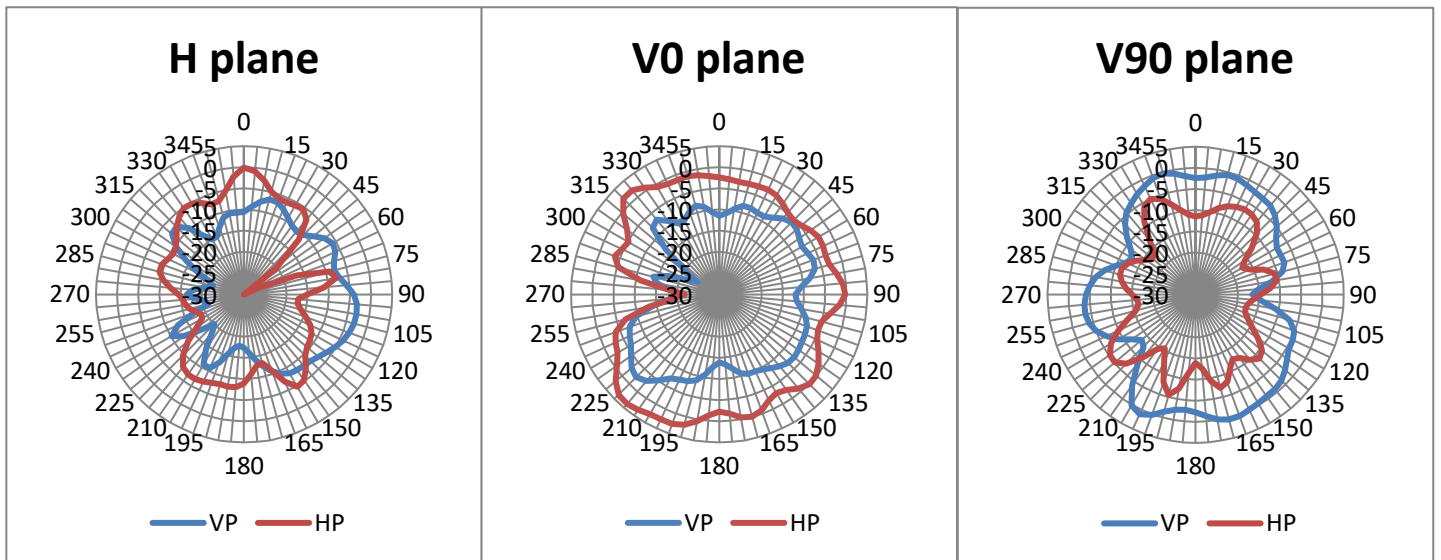

Tri band Wi-Fi Flexible Printed Antenna (2.4/5/6 GHz)



AFG4507W2

Request Samples



Check Inventory



45.0 x 7.8 x 0.2 mm
RoHS/RoHS II Compliant
MSL Level = N/A

6.525 GHz Band

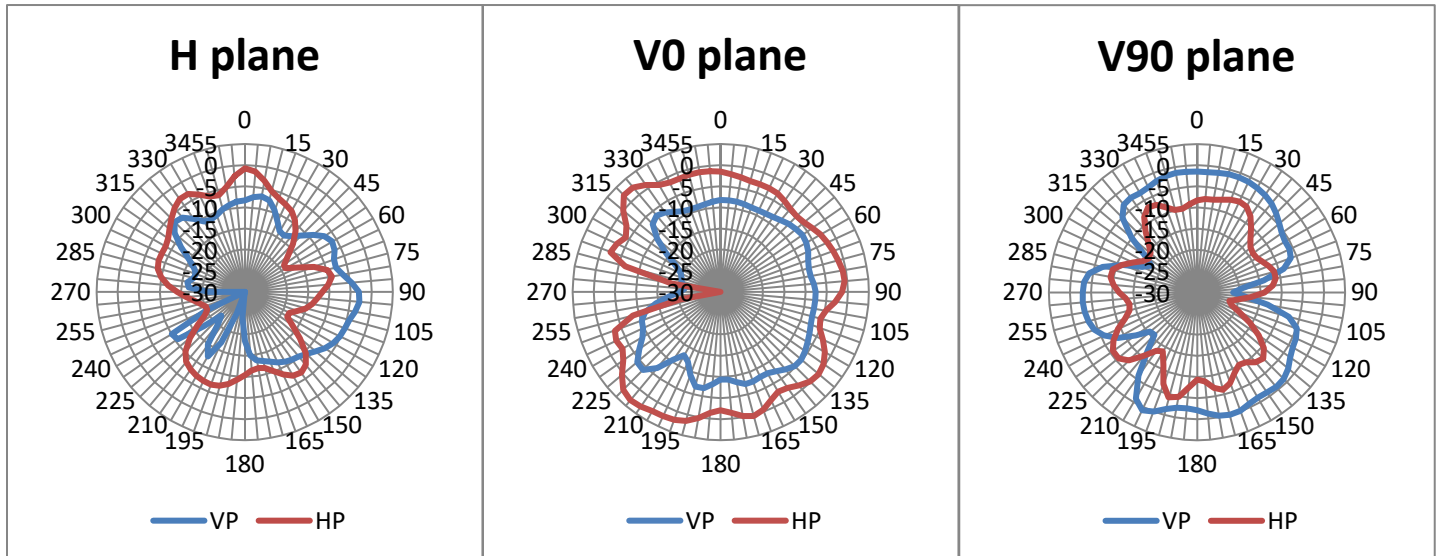

6.875 GHz Band

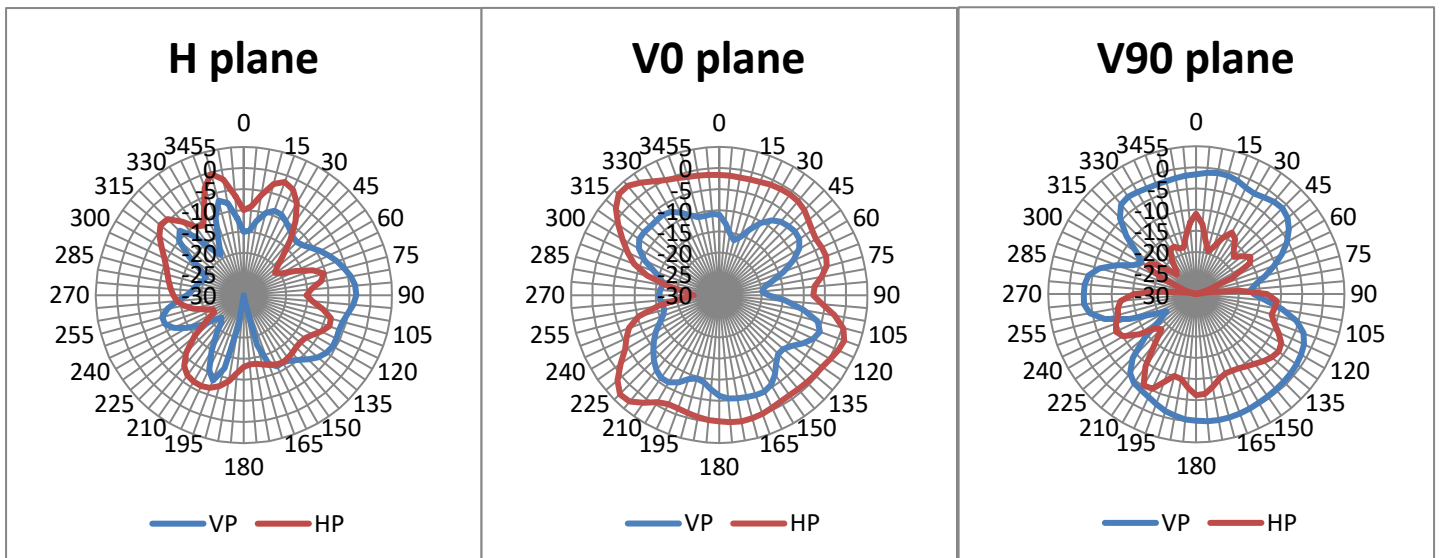

Tri band Wi-Fi Flexible Printed Antenna (2.4/5/6 GHz)



AFG4507W2

Request Samples



Check Inventory



45.0 x 7.8 x 0.2 mm
RoHS/RoHS II Compliant
MSL Level = N/A

7.125 GHz Band

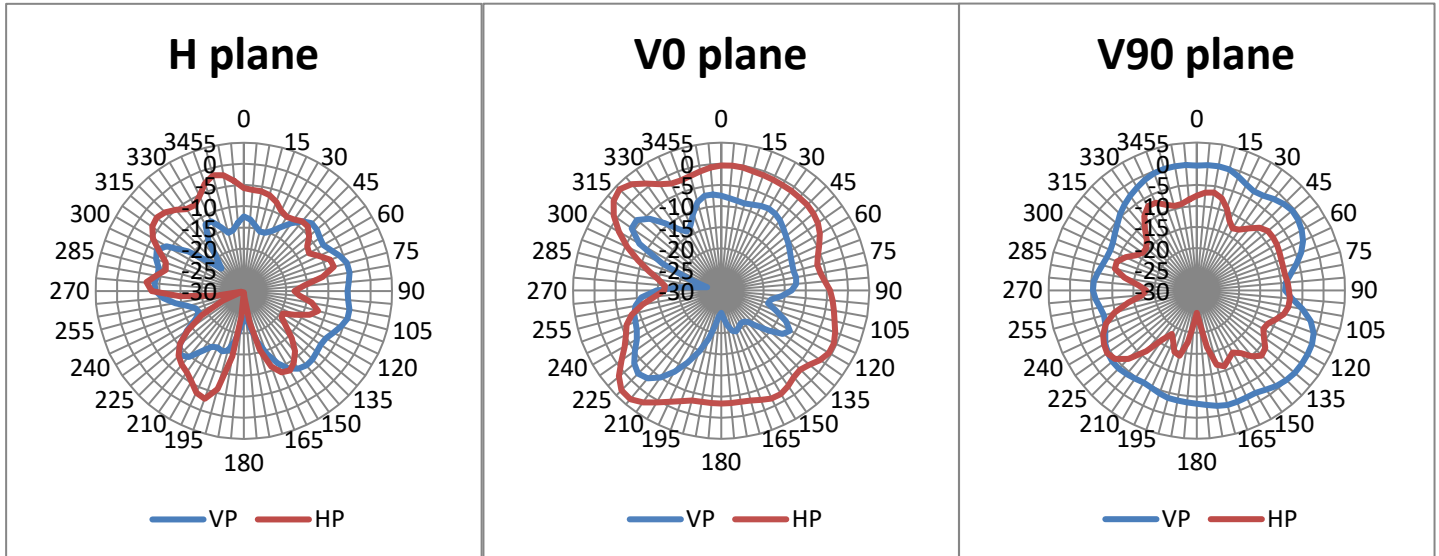

Tri band Wi-Fi Flexible Printed Antenna (2.4/5/6 GHz)



AFG4507W2

Request Samples



Check Inventory



45.0 x 7.8 x 0.2 mm
RoHS/RoHS II Compliant
MSL Level = N/A

Efficiency

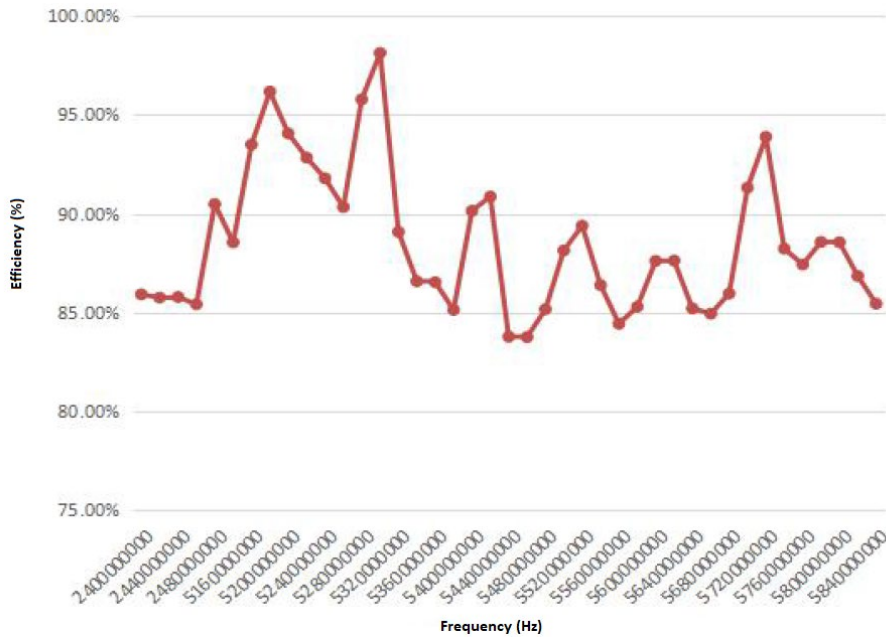

Packaging Information

Number of Antenna/ Carton: 1000 pcs

Dimension of the Carton: 630 x 460 x 105mm

ATTENTION: Abracon LLC's products are COTS – Commercial-Off-The-Shelf products; suitable for Commercial, Industrial and, where designated, Automotive Applications. Abracon's products are not specifically designed for Military, Aviation, Aerospace, Life-dependent Medical applications or any application requiring high reliability where component failure could result in loss of life and/or property. For applications requiring high reliability and/or presenting an extreme operating environment, written consent and authorization from Abracon LLC is required. Please contact Abracon LLC for more information.



5101 Hidden Creek Ln Spicewood TX 78669
Phone: 512-371-6159 | Fax: 512-351-8858
For terms and conditions of sales, please visit:
www.abracon.com

REVISED: 09-14-22

ABRACON IS
ISO9001-2015
CERTIFIED