

Data sheet | Item number: 890-284

Socket; 4-pole; Cod. B; 1,50 mm²; pink

www.wago.com/890-284

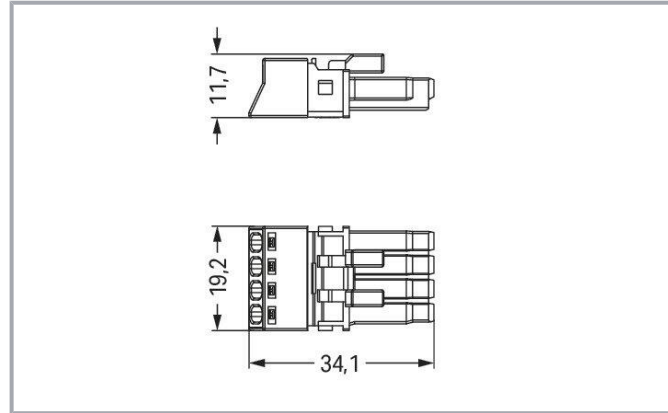
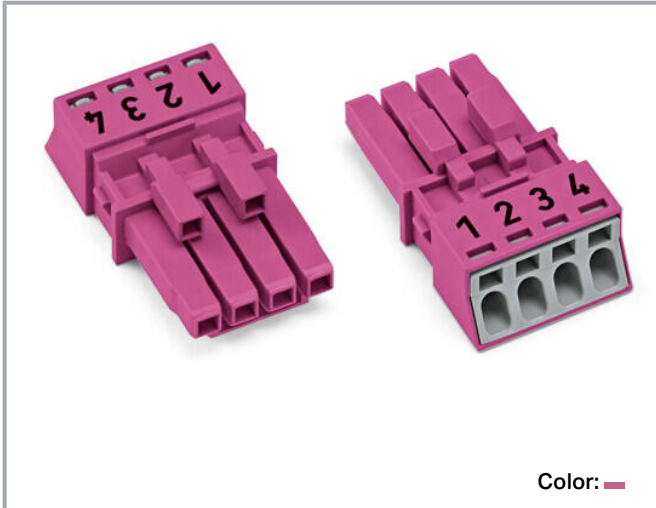

Item description

Female connector/socket *WAGOSTA*® MINI with protection type IP20

For signal and power transmission: The *WAGOSTA*® MINI female connector/socket rated current 16 A. Whether on PCBs, in control cabinets or for connecting lights – pluggable installation connectors from WAGO allow you to establish connections according to various requirements in seconds. The mechanical coding and color coding of the pluggable installation connector ensure error-free installation of the individual components – including protection against mismatching. Pluggable installation connectors with B coding from the *WAGOSTA*® MINI line are available in pink, light green, or gray, allowing you to distinguish different circuits, for example for light, pumps or, sun blinds. Customer-specific pole marking is possible as well. If only limited space is available, our smallest pluggable connection system, *WAGOSTA*® MINI, conveniently displays its strengths. It is very compact, and, thanks to Push-in CAGE CLAMP® spring pressure connection technology, it additionally saves time, since the installation is low-maintenance and requires no screw connections.

Push-in CAGE CLAMP® spring pressure connection technology – pluggable installation instead of laborious screw connections!

The *WAGOSTA*® Pluggable Connection System is ideally tailored to the very strict requirements of building installation. It makes electrical installation pluggable, and thus faster, even more reliable, and error-free. Using this pre-assembled system decreases assembly times and installation errors at the construction site. Now you can also cut installation expenses without compromising safety and quality: The *WAGOSTA*® MINI pluggable installation

Subject to changes. Please also observe the further product documentation!

WAGO GmbH & Co. KG
Hansastr. 27
32423 Minden
Phone: +49571 887-0 | Fax: +49571 887-169
Email: info.de@wago.com | Web: www.wago.com

Do you have any questions about our products?
We are always happy to take your call at +49 (571) 887-44222.



connector with marking reduces the need for servicing and prevents unnecessary downtime.

- effective protection against mismatching
- consistent IP40 protection
- with B coding for use in automation of processes, such as lighting technology
- ready for immediate use
- rapid, structured electrical installation

Data

Notes

Variants:

Other pole markings

Other versions (or variants) can be requested from WAGO Sales or configured at <https://configurator.wago.com/>.

Electrical data

Ratings per IEC/EN

Ratings per	IEC/EN 60664-1
Nominal voltage (III/3)	400 V
Rated impulse voltage (III/3)	6 kV
Rated current	16 A
Note (rated current)	13 A for 3-pole load 10 A for 4-pole load
Legend (ratings)	(III / 3) ≙ Overvoltage category III / Pollution degree 3

Ratings per UL 1977

Note for the US market

Some versions may also be used for current interruption in accordance with the UL certificate in select applications with currents below 5 A and voltages up to 600 V. For further information, please contact your local sales office.

Rated voltage (UL 1977)	600 V
Rated current UL 1977	12 A

General

Note on contact resistance

approx. 1 mΩ of contact resistance
approx. 0.25 mΩ contact transition plug/socket

Subject to changes. Please also observe the further product documentation!

WAGO GmbH & Co. KG

Hansastr. 27

32423 Minden

Phone: +49571 887-0 | Fax: +49571 887-169

Email: info.de@wago.com | Web: www.wago.com

Do you have any questions about our products?

We are always happy to take your call at +49 (571) 887-44222.



Connection data

Connection points	4
Total number of potentials	4

Connection 1

Connection technology	Push-in CAGE CLAMP®
Actuation type	Operating tool Push-in
Nominal cross-section	1.5 mm ² / 16 AWG
Solid conductor	0.25 ... 1.5 mm ² / 22 ... 16 AWG
Solid conductor; push-in termination	0.75 ... 1.5 mm ² / 20 ... 16 AWG
Stranded conductor	0.25 ... 1 mm ² / 22 ... 18 AWG
Fine-stranded conductor	0.25 ... 1.5 mm ² / 22 ... 16 AWG
Fine-stranded conductor; with insulated ferrule	0.25 ... 0.75 mm ² / 22 ... 20 AWG
Fine-stranded conductor; with uninsulated ferrule	0.25 ... 0.75 mm ² / 22 ... 20 AWG
Fine-stranded conductor; with ferrule; push-in termination	0.75 mm ² / 20 AWG
Strip length	9 mm / 0.35 inches
Pole number	4
Conductor entry direction to mating direction	0°

Physical data

Pin spacing	4.4 mm / 0.173 inches
Width	19.2 mm / 0.756 inches
Height	11.7 mm / 0.461 inches
Depth	34.1 mm / 1.343 inches

Mechanical Data

Application	Control technology
Coding	B
Variable coding	No
Marking	1 2 3 4
Potential marking	1 2 3 4
Mating force of a plug-in connection	approx. 20 ... 70 N (depending on pole number)
Retention force of a plug-in connection	Locked: > 80 N
Unmating force of a plug-in connection	Unlocked: approx. 20 ... 70 N (depending on pole number)
Number of mating cycles	200, without resistive load

Subject to changes. Please also observe the further product documentation!



Protection type	IP20; IP40 with strain relief housing
-----------------	---------------------------------------

Plug-in connection

Contact type (pluggable connector)	Female connector/socket
Connector (connection type)	for conductor
Mismating protection	Yes
Note on mismating protection	All <i>WINSTA</i> [®] components are 100% protected against mismating when: a.) plugging different numbers of poles b.) plugging while rotated 180 c.) plugging while laterally staggered d.) plugging one pole
Locking lever	Can be retrofitted
Locking of plug-in connection	locking lever
Note on locking system	All connectors for mounted installations (snap-in versions for lighting fixtures or devices, all types of PCB and distribution connectors) are factory-equipped with locking levers to ensure plugs and sockets are securely locked. Additional locking levers are only required for flying leads (plug/socket).

Material Data

Note (material data)	Information on material specifications can be found here
Color	pink
Cover color	gray
Material group	I
Insulation material	Polyamide (PA66)
Flammability class per UL94	V0
Clamping spring material	Chrome-nickel spring steel (CrNi)
Contact material	Copper or copper alloy; surface-treated
Contact plating	Tin
Fire load	0.033 MJ
Weight	4.9 g

Environmental requirements

Processing temperature	-5 ... +40 °C
Continuous operating temperature	-35 ... +85 °C
Note on continuous operating temperature	Insulating parts for temperatures ≤ 105 °C

Subject to changes. Please also observe the further product documentation!

WAGO GmbH & Co. KG
Hansastr. 27
32423 Minden
Phone: +49571 887-0 | Fax: +49571 887-169
Email: info.de@wago.com | Web: www.wago.com

Do you have any questions about our products?
We are always happy to take your call at +49 (571) 887-44222.

Commercial data



Product Group	20 (Winsta)
eCl@ss 10.0	27-44-06-05
eCl@ss 9.0	27-44-06-05
ETIM 8.0	EC002560
ETIM 7.0	EC002560
PU (SPU)	50 pcs
Packaging type	box
Country of origin	PL
GTIN	4055143523646
Customs tariff number	85366990990

Environmental Product Compliance

RoHS Compliance Status	Compliant, No Exemption
------------------------	-------------------------

Approvals / Certificates

General approvals

Logo	Approval	Additional Approval Text	Certificate name
	CB DEKRA Certification B.V.	IEC 61984	NL-64351
	CB DEKRA Certification B.V.	EN 61984	71-112993
	cURus Underwriters Laboratories Inc.	UL 1977	E45171
	KEMA/KEUR DEKRA Certification B.V.	EN 60320	2148952.04

Declarations of conformity and manufacturer's declarations



Logo	Approval	Additional Approval Text	Certificate name
	EU-Declaration of Conformity WAGO GmbH & Co. KG	-	-

Subject to changes. Please also observe the further product documentation!







UK-Declaration of Conformity
WAGO GmbH & Co. KG

Approvals for marine applications

Logo	Approval	Additional Approval Text	Certificate name
	DNV GL Det Norske Veritas, Germanischer Lloyd	-	TAE00001Z6
	LR Lloyds Register	EN 61535	08/20047 (E2)

Counterpart

	Item no.890-1633 T-distribution connector; 4-pole; Cod. B; 1 input; 2 outputs; 2 locking levers; pink	www.wago.com/890-1633
	Item no.890-1683 h-distribution connector; 4-pole; Cod. B; 1 input; 2 outputs; outputs on one side; 2 locking levers; pink	www.wago.com/890-1683
	Item no.890-1783 h-distribution connector; 4-pole; Cod. B; 1 input; 2 outputs; outputs on one side; 3 locking levers; for flying leads; pink	www.wago.com/890-1783
	Item no.890-1736 3-way distribution connector; 4-pole; Cod. B; 1 input; 3 outputs; pink	www.wago.com/890-1736
	Item no.890-1733 T-distribution connector; 4-pole; Cod. B; 1 input; 2 outputs; 3 locking levers; for flying leads; pink	www.wago.com/890-1733

Subject to changes. Please also observe the further product documentation!

WAGO GmbH & Co. KG
Hansastr. 27
32423 Minden
Phone: +49571 887-0 | Fax: +49571 887-169
Email: info.de@wago.com | Web: www.wago.com

Do you have any questions about our products?
We are always happy to take your call at +49 (571) 887-44222.



Item no.890-294
Plug; 4-pole; 1,50 mm²; pink

www.wago.com/890-294



Item no.890-794
Snap-in plug; 4-pole; Cod. B; 1,50 mm²; pink

www.wago.com/890-794



Item no.890-894
Plug for PCBs; straight; 4-pole; Cod. B; pink

www.wago.com/890-894



Item no.890-894/011-000
Plug for PCBs; angled; 4-pole; Cod. B; pink

www.wago.com/890-894/011-000

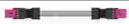

Item no.891-8994/005-107
pre-assembled interconnecting cable; Eca; Socket/plug; 4-pole; Cod. B; Control cable 4 x 1.0 mm²; 1 m; 1,00 mm²; pink

www.wago.com/891-8994/005-107



Item no.891-8994/205-107
pre-assembled connecting cable; Eca; Plug/open-ended; 4-pole; Cod. B; Control cable 4 x 1.0 mm²; 1 m; 1,00 mm²; pink

www.wago.com/891-8994/205-107

Required accessories

Locking levers

Locking system



Item no.: 890-111
Locking lever; for flying leads; for tool operation; black

www.wago.com/890-111



Item no.: 890-101
Locking lever; for manual operation; black

www.wago.com/890-101



Item no.: 890-121
Locking lever; for manual operation; white

www.wago.com/890-121



Item no.: 890-131
Locking lever; for flying leads; for tool operation; white

www.wago.com/890-131

Strain relief

Strain relief housing



Item no.: 890-504
Strain relief housing; 4-pole; with locking clip; for 1 cable; 6.5 ... 10.5 mm; 45 mm; black

www.wago.com/890-504

Subject to changes. Please also observe the further product documentation!



Item no.: 890-514

Strain relief housing; 4-pole; with locking clip; for 1 cable; 6.5 ... 10.5 mm; 45 mm; white

www.wago.com/890-514

Optional accessories

Cover

Cover



Item no.: 897-2003

Protective cap; Type2; for sockets and plugs; PVC; red

www.wago.com/897-2003

Mounting

Mounting accessories



Item no.: 890-310

Mounting carrier; 2- to 5-pole; for flying leads; black

www.wago.com/890-310



Item no.: 890-311

Mounting carrier; 2- to 5-pole; for flying leads; white

www.wago.com/890-311

Tool

Operating tool



Item no.: 210-719

Operating tool; Blade: 2.5 x 0.4 mm; with a partially insulated shaft

www.wago.com/210-719



Item no.: 890-384

Operating tool; 4-way; green

www.wago.com/890-384

Downloads

Documentation

Bid Text

890-284 X81 - Datei	2019 Feb 19	xml 3.0 kB	Download
890-284 doc - Datei	2015 Jun 8	doc 24.1 kB	Download

Subject to changes. Please also observe the further product documentation!

CAD/CAE-Data

CAD data

2D/3D Models 890-284	URL	Download
----------------------	-----	----------

CAE data

ZUKEN Portal 890-284	URL	Download
----------------------	-----	----------

WSCAD Universe 890-284	URL	Download
------------------------	-----	----------

Environmental Product Compliance

Compliance Search

Environmental Product Compliance 890-284	URL	Download
--	-----	----------

Socket; 4-pole; Cod. B; 1,50 mm²; pink

Installation Notes

Conductor termination

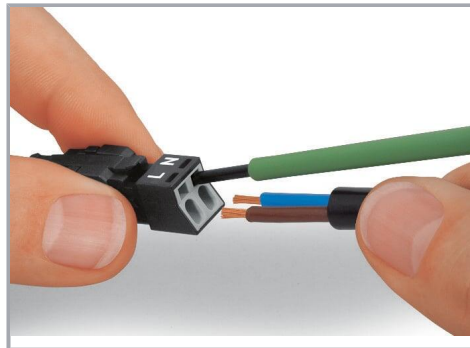
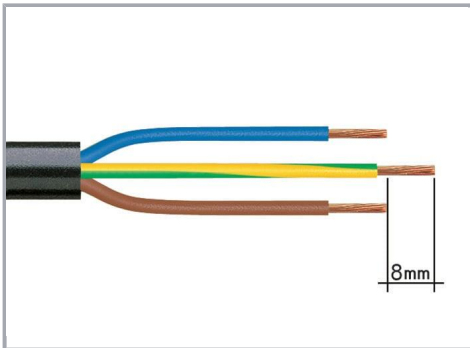

1. Strip length, outer insulation = 30 mm (2-pole), 37 mm (3-pole), 45 mm (4- and 5-pole)

2. Strip length = 9 mm

3. Extended ground conductor = 8 mm

To terminate fine-stranded conductors, open the clamping unit via screwdriver – 2.5 mm blade width – and insert a stripped conductor until it hits the backstop.

Terminate solid conductors by simply pushing them in.

Subject to changes. Please also observe the further product documentation!

WAGO GmbH & Co. KG

Hansastr. 27

32423 Minden

Phone: +49571 887-0 | Fax: +49571 887-169

Email: info.de@wago.com | Web: www.wago.com

Do you have any questions about our products?

We are always happy to take your call at +49 (571) 887-44222.

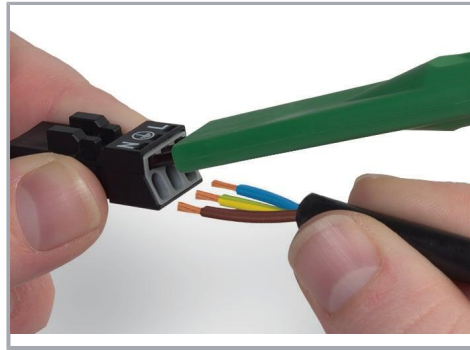
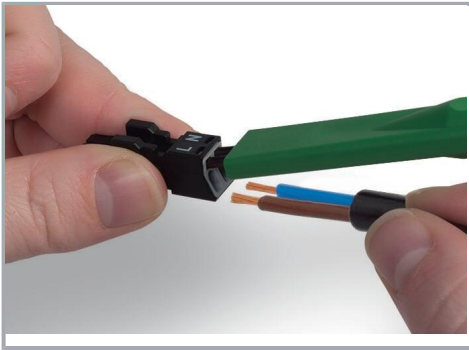

To terminate fine-stranded conductors, open clamping units via operating tool (890-382) and insert stripped conductors until they hit backstop.

To terminate fine-stranded conductors, open clamping units via operating tool (890-383) and insert stripped conductors until they hit backstop.

Terminate solid conductors by simply pushing them in.

Terminate solid conductors by simply pushing them in.

Installation

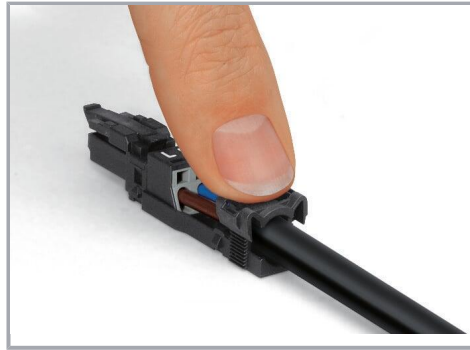
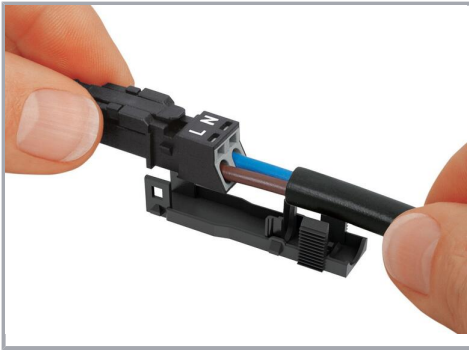

Latch the wired connector into the base of the strain relief housing.

Push down strain relief clamp by hand.

Subject to changes. Please also observe the further product documentation!



Push down strain relief clamp with 2.5 mm screwdriver alternately on both sides.

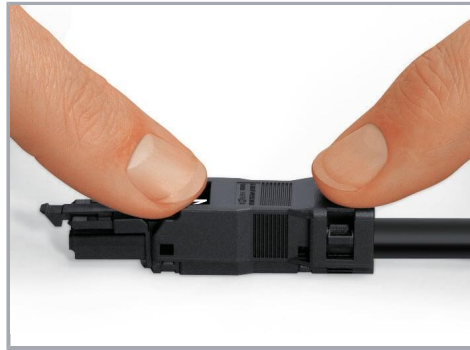

Latch the top of the strain relief housing.



The printed marking of the connector is clearly visible in the openings of the strain relief housing.

Mismatching protection

Subject to changes. Please also observe the further product documentation!

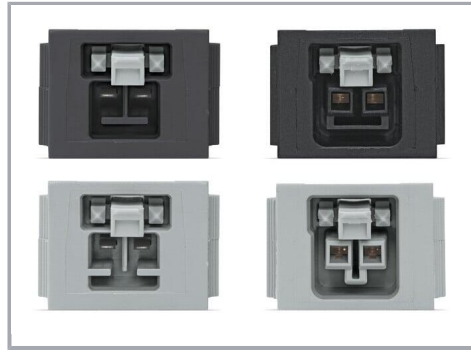
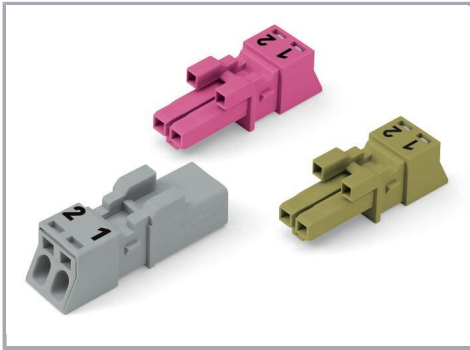

B-coded connectors with different colors can be plugged together.

Important note:

Different colors and/or pole markings are used for circuit identification.

Only connectors of the same color and same pole marking must be plugged together.

B-coded connectors (shown in gray) not only differ in color, but also in their design, making them incompatible with other coded connectors.



Product family

WINSTA® MINI

[Show all products from the family](#)

Subject to changes. Please also observe the further product documentation!