



GlobalTech Display

A Professional LCD Displays Provider

TFT LCD Display Specification

PN: GLT0701024600IS4-CTP

Overview:

- 7.0" Diagonal
- IPS, Full View Angle
- Driver: HX8282-A11+HX8696-A01
- 16.7M Colors
- 900 Nits
- 1024 x 600 Pixels
- Transmissive/Normally Black
- 24-bit RGB Interface
- Capacitive Touch Panel
- RoHS Compliant

9825 Widmer Road, Lenexa, KS 66215, USA | Tel: 913-828-5685 Fax: 913-273-4397

Email: sales@gtdisplays.com Website: www.gtdisplays.com

Table of Contents

1. Record of Revision.....	2
2. General Specifications	3
3. Input / Output Terminals	4
4. Absolute Maximum Rating	5
5. Electrical Characteristics.....	5
6. Interface Timing.....	7
7. Optical Characteristics	11
8. Environmental / Reliability Tests.....	14
9. Mechanical Drawing.....	15
10. Packing	16
11. TFT- LCD Module Inspection Criteria	17
12. Precautions for Use of LCD modules	23

1. Record of Revision

Rev	Issued Date	Description	Editor
1.0	5/8/2020	First Release	ZWF

2. General Specifications

	Feature	Spec
Characteristics	Size	7 inch
	Resolution	1024(horizontal) x 600(Vertical)
	Interface	24-bit RGB
	Connect type	Connector
	Display Colors	16.7M
	Technology type	a-Si
	Pixel pitch (mm)	0.150 x 0.143
	Pixel Configuration	R.G.B.-Stripe
	Display Mode	Normally Black
	LCD Driver IC	HX8282-A11+HX8696-A01
	CTP Driver IC	GT911
	Viewing Direction	Full view
Mechanical	LCM (W x H x D) (mm)	175.80 x 109.24 x 7.68
	Active Area(mm)	154.21 x 85.92
	With /Without TSP	With CTP
	Weight (g)	~225g
	LED Numbers	30 LEDs

Note 1: Requirements on Environmental Protection: RoHs

Note 2: LCM weight tolerance: +/- 5%

3. Input / Output Terminals

3.1 LCD Pin Assignment

No.	Symbol	Description
1-2	LED+	LED Anode
3-4	LED-	LED Cathode
5	GND	Ground
6	VCOM	Common Voltage
7	DVDD	Power Voltage for digital circuit
8	MODE	DE / SYNC mode select under TTL mode. Normally pull high H: DE mode. L: HSD/VSD mode.
9	DE	Data enable input. Active high to enable the input data bus under "DE Mode."
10	VS	Vertical sync input. Negative polarity.
11	HS	Horizontal sync input. Negative polarity.
12-19	B7-B0	Data bus
20-27	G7-G0	Data bus
28-35	R7-R0	Data bus
36	GND	Ground
37	DCLK	Dot clock signal input. Latching input data at its rising edge.
38	GND	Ground
39	L/R	Horizontal inversion (Note 1)
40	U/D	Vertical inversion (Note 1)
41	VGH	Gate ON Voltage
42	VGL	Gate oFF Voltage Power supply
43	AVDD	Power for Analog Circuit
44	RESET	Global reset pin
45	NC	No connection
46	VCOM	Common Voltage
47	DITHB	Dithering function enable control
48	GND	Ground
49	NC	No connection
50	NC	No connection

Note 1: when L/R=0 set right to left scan direction
when L/R=1 set left to right scan direction
when U/D=0 set top to bottom scan direction
when U/D=1 set bottom to top scan direction

3.2 CTP Pin Assignment

Pin	Signal	Description
1	GND	Ground
2	VDD	Power supply
3	SDA	I2C data input and output
4	SCL	I2C clock input
5	RST	Reset Pin for CTP
6	INT	Interrupt request to the host
7	Test-NC	No connection
8	VSS-GND	Ground

4. Absolute Maximum Rating

Item	Symbol	MIN	TYP	MAX	Unit	Remark
Supply Voltage	VDD	-0.3	-	5	V	-
Operating Temperature	TOPR	-20	-	70	°C	-
Storage Temperature	TSTG	-30	-	80	°C	

5. Electrical Characteristics

5.1 Driving TFT LCD Panel

Item	Symbol	MIN	TYP	MAX	Unit	Remark
Power supply for LCD	VDD	3.0	3.3	3.6	V	
	AVDD	9.0	9.8	10.5	V	
	VGH	16.0	18.0	20	V	
	VGL	-7.5	-6.0	-5.0	V	
	VCOM	2.9	3.25	3.5	V	

5.2 CTP Electrical Characteristics

FPC Design	Item	Description	Remark
COF	IC solution on TP Model	GT911	
	Touch Count Max	5 point	
	Display Resolution	1024 x 600	
	Interface Type	I2C	
	I2C Slave Address	0x28	
	Origin of Coordinate	Top left corner	

Parameter	Min	TYP	Max	Unit
Interface Signal Voltage	-	3.3	-	V
Power Voltage	VDD	3.3	-	V

5.3 LED Driving Conditions

Item	Symbol	MIN	TYP	MAX	Unit	Remark
Forward Current	I_F	-	400	-	mA	
Forward Voltage	V_F	8.4	9.6	10.8	V	
Backlight Power consumption	W_{BL}	-	3.84	-	W	
LED Lifetime		-	30000	-	Hrs	

Note 1: Each LED: $I_F = 40\text{mA}$, $V_F = 3.2\text{V} \pm 0.4\text{V}$.

Note 2: Optical performance should be evaluated at $T_a = 25^\circ\text{C}$ only.

Note 3: If LED is driven by high current, high ambient temperature & humidity condition. The life Time of LED will be reduced. Operating life means brightness goes down to 50% initial brightness. Typical operating life time is estimated data.

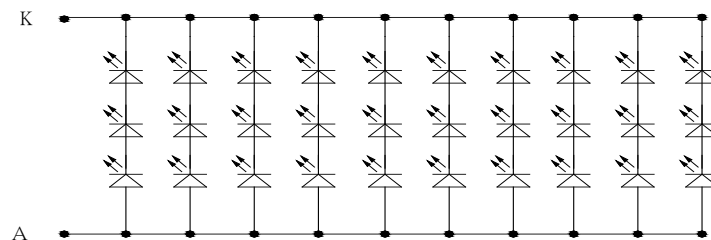
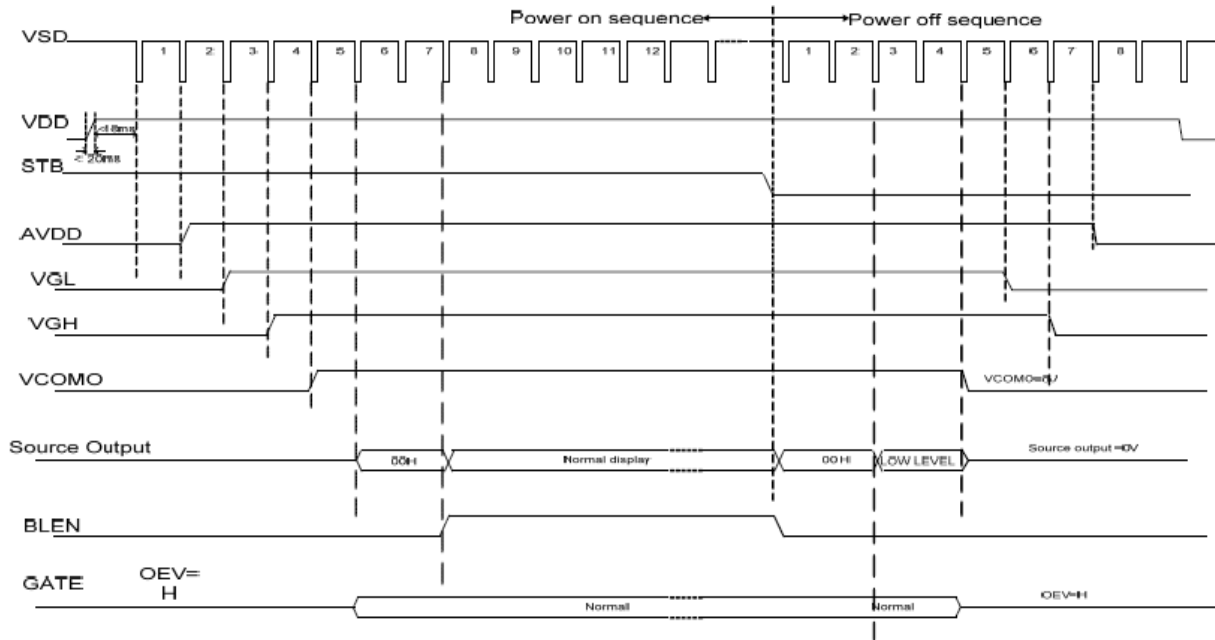

Figure: LED connection of backlight (Constant Current)

6. Interface Timing

6.1 Power-On/Off Timing Sequence



6.2 Power On/Off timing chart

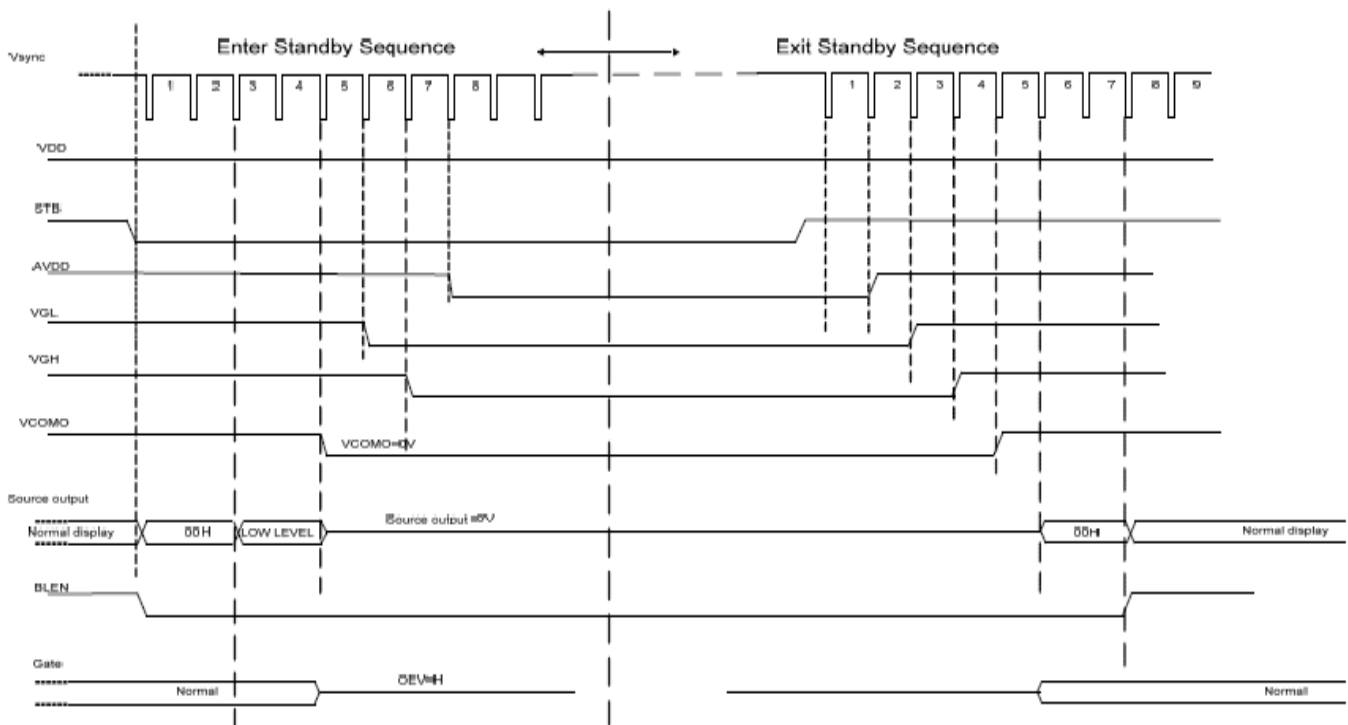

6.3 Vertical input timing

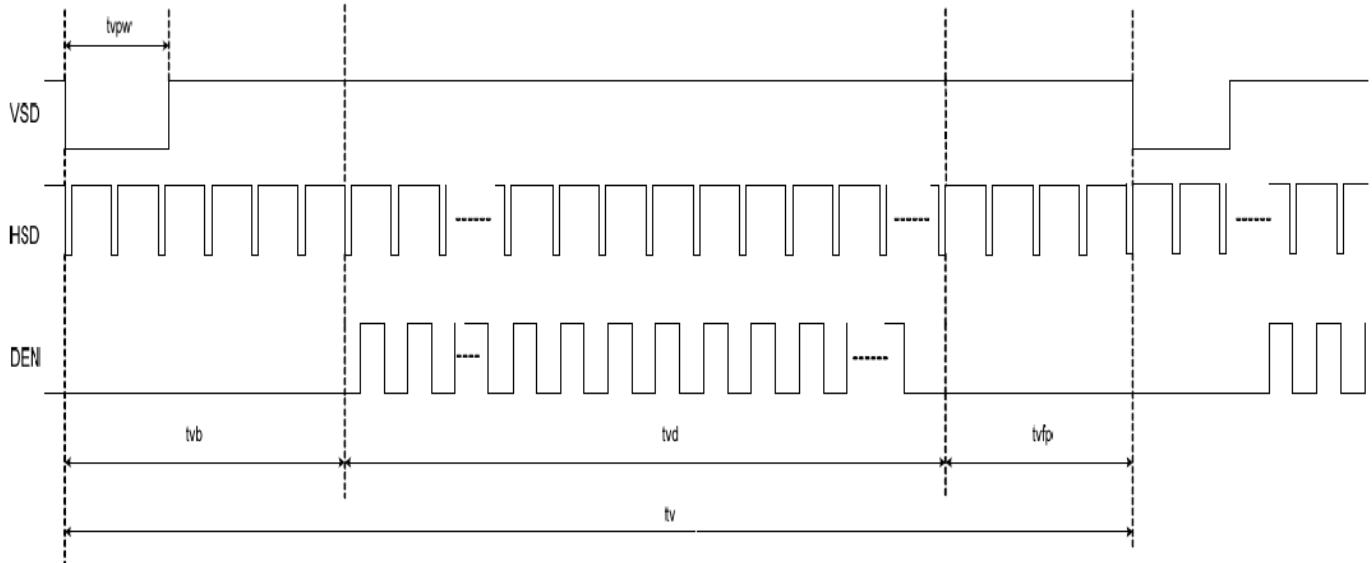

6.4 Horizontal input timing

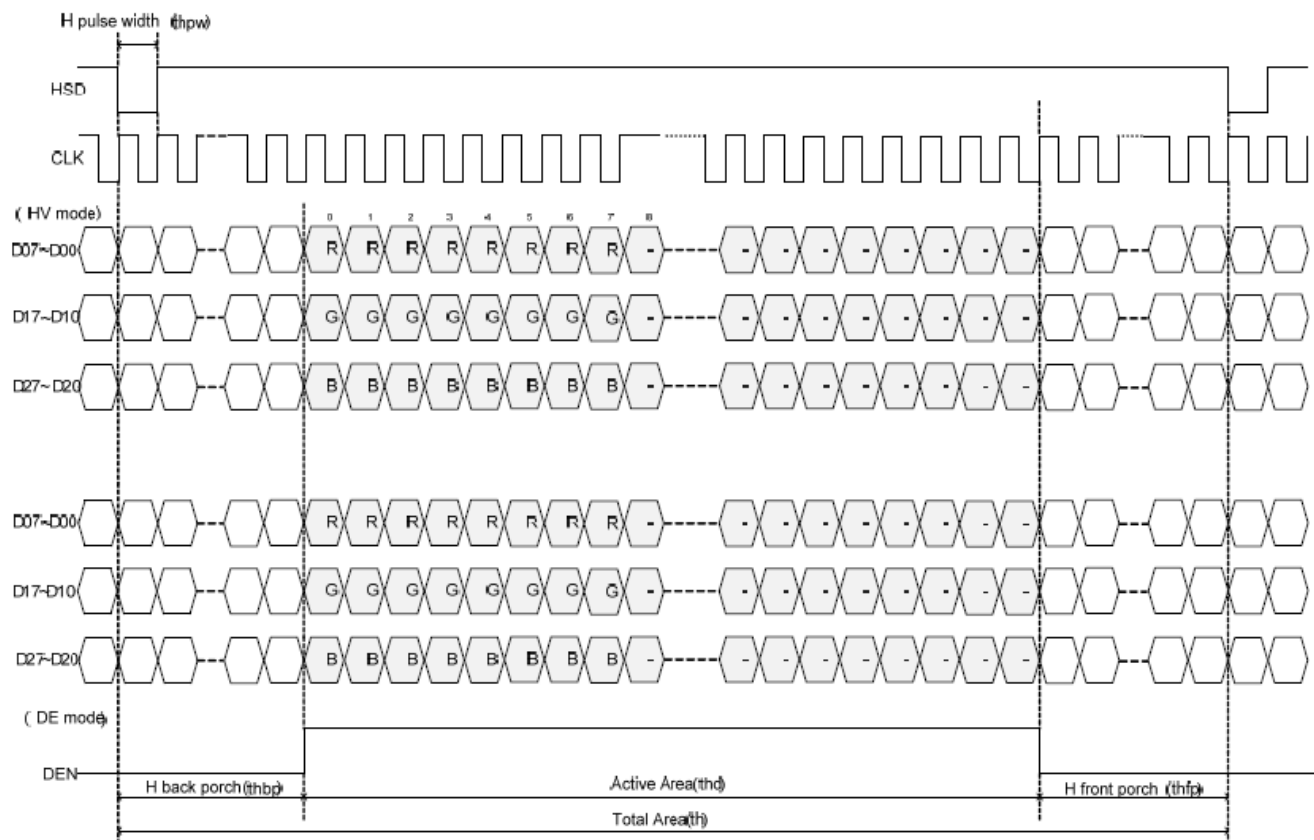

6.5 AC Electrical Characteristics

DE mode

DE mode					
Parameter	Symbol	Value			Unit
		Min.	Typ.	Max.	
DCLK frequency @Frame rate=60hz	fclk	40.8	51.2	67.2	Mhz
Horizontal display area	thd	1024			DCLK
HSYNC period time	th	1114	1344	1400	DCLK
HSYNC blanking	thb+thfp	90	320	378	DCLK
Vertical display area	tvd	600			H
VSYNC period time	tv	610	635	800	H
VSYNC blanking	tvb+tvfp	10	35	200	H

HV mode(1)

HV mode					
Horizontal input timing					
Parameter	Symbol	Value			Unit
Horizontal display area	thd	1024			DCLK
DCLK frequency@ Frame rate=60hz	fclk	Min.	Typ.	Max.	Mhz
		44.9	51.2	63	
1 Horizontal Line	th	1200	1344	1400	DCLK
HSYNC pulse width	thpw	Min.	1		
		Typ.	-		
		Max.	140		
HSYNC back porch	thbp	160	160	160	
HSYNC front porch	thfp	16	160	216	

HV mode(2)

Vertical input timing					
Parameter	Symbol	Value			Unit
		Min.	Typ.	Max.	
Vertical display area	tvd	600			H
VSYNC period time	tv	624	635	750	H
VSYNC pulse width	tvpw	1	-	20	H
VSYNC back porch	tvb	23	23	23	H
VSYNC front porch	tvfp	1	12	127	H

6.6 Capacitive touch panel Specification

I2C

The I2C is always configured in the Slave mode. The data transfer format is shown in Figure 2-4.

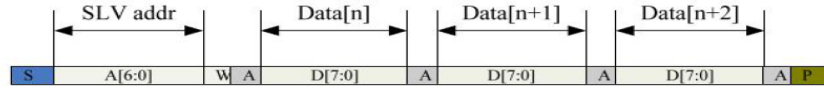
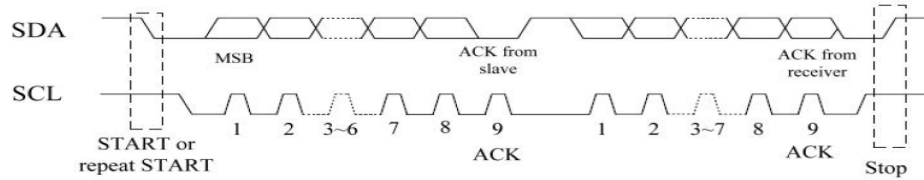

Figure 2-5 I2C master write, slave read

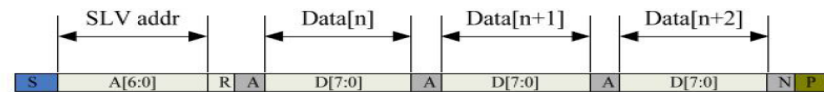

Figure 2-6 I2C master read, slave write

Table 2-1 lists the meanings of the mnemonics used in the above figures.

Table 2-1 Mnemonics Description

Mnemonics	Description
S	I2C Start or I2C Restart
A[6:0]	Slave address A[6:4]: 3'b011 A[3:0]: data bits are identical to those of I2CCON[7:4] register.
W	1'b0: Write
R	1'b1: Read
A(N)	ACK(NACK)
P	STOP: the indication of the end of a packet (if this bit is missing, S will indicate the end of the current packet and the beginning of the next packet)

I2C Interface Timing Characteristics is shown in Table 2-2.

Table 2-2 I2C Timing Characteristics

Parameter	Unit	Min	Max
SCL frequency	KHz	0	400
Bus free time between a STOP and START condition	us	4.7	\
Hold time (repeated) START condition	us	4.0	\
Data setup time	ns	250	\
Setup time for a repeated START condition	us	4.7	\
Setup Time for STOP condition	us	4.0	\

7. Optical Characteristics

Items	Symbol	Condition	Min.	Typ.	Max.	Unit	Remark	Note
Response time	Tr+Tf	-	-	30	40	ms	FIG.1	Note4
Contrast Ratio	CR		500	800	-	-	FIG.2	Note1
Surface luminance	LV	$\theta = 0^\circ$	750	900	-	cd/m2	FIG.2	Note2
Luminance uniformity	Yu	$\theta = 0^\circ$	70	-	-	%	FIG.2	Note3
NTSC	-	$\theta = 0^\circ$	-	50	-	%	FIG.2	Note5
Viewing angle	θ_T	Center CR \geq 10	-	85	-	deg	FIG.3	Note6
	θ_B		-	85	-	deg	FIG.3	
	θ_L		-	85	-	deg	FIG.3	
	θ_R		-	85	-	deg	FIG.3	
Chromaticity	Red	R _X	0.549	0.599	0.649	-	FIG.2 CIE1931	Note5
		R _Y	0.288	0.338	0.388	-		
	Green	G _X	0.249	0.299	0.349	-		
		G _Y	0.500	0.550	0.600	-		
	Blue	B _X	0.089	0.139	0.189	-		
		B _Y	0.081	0.131	0.183	-		
	White	W _X	0.275	0.325	0.375	-		
		W _Y	0.310	0.360	0.410	-		

Note1. Definition of contrast ratio

Contrast ratio (Cr) is defined mathematically by the following formula. For more information see FIG.2.

$$\text{Contrast ratio} = \frac{\text{Luminance measured when LCD on the "White" state}}{\text{Luminance measured when LCD on the "Black" state}}$$

For contrast ratio, Surface Luminance, Luminance uniformity and CIE, the testing data is based on TOPCON's BM-5 or BM-7 photo detector or compatible.

Note2. Definition of surface luminance

Surface luminance is the luminance with all pixels displaying white. For more information see FIG.2.

L_v = Average Surface Luminance with all white pixels (P1,P2,P3,, Pn)

Note3. Definition of luminance uniformity

The luminance uniformity in surface luminance is determined by measuring luminance at each test position 1 through n, and then dividing the maximum luminance of n points luminance by minimum luminance of n points luminance. For more information see FIG.2.

$$YU = \frac{\text{Minimum surface luminance with all white pixels (P1,P2,P3,.....,Pn)}}{\text{Maximum surface luminance with all white pixels (P1,P2,P3,.....,Pn)}}$$

Note4. Definition of response time

The response time is defined as the LCD optical switching time interval between “White” state and “Black” state. Rise time (Tr) is the time between photo detector output intensity changed from 90% to 10%. And fall time (Tf) is the time between photo detector output intensity changed from 10% to 90%. For additional information see FIG1.

Note5. Definition of color chromaticity (CIE1931)

CIE (x,y) chromaticity, The x,y value is determined by screen active area center position P5. For more information see FIG.2.

Note6. Definition of viewing angle

Viewing angle is the angle at which the contrast ratio is greater than 10. Angles are determined for the horizontal or x axis and the vertical or y axis with respect to the z axis which is normal to the LCD surface. For more information see FIG.3.

For viewing angle and response time testing, the testing data is base on Autronic-Melchers’s ConoScope or DMS series Instruments or compatible.

FIG.1. The definition of response Time

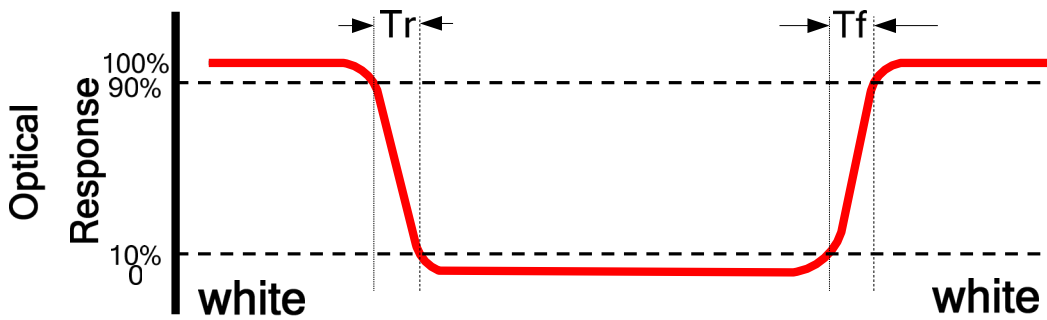

FIG.2. Measuring method for contrast ratio, surface luminance, luminance uniformity, CIE (x,y) chromaticity

Size: $S \leq 5"$ (see Figure a) A : 5mm B: 5mm
 H,V: Active area
 Light spot size $\phi = 5\text{mm}$ (BM-5) or $\phi = 7.7\text{mm}$ (BM-7) 50cm distance or compatible distance from the LCD surface to detector lens.
 test spot position : see Figure a.
 measurement instrument : TOPCON’s luminance meter BM-5 or BM-7 or compatible (see Figure c).

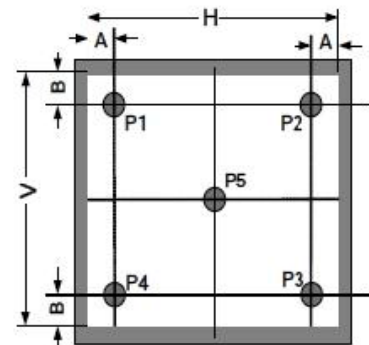

Figure a

Size: $5" < S \leq 12.3"$ (see Figure b) H,V : Active area
 Light spot size $\phi = 5\text{mm}$ (BM-5) or $\phi = 7.7\text{mm}$ (BM-7) 50cm distance or compatible distance from the LCD surface to detector lens.
 test spot position : see Figure b.
 measurement instrument : TOPCON’s luminance meter BM-5 or BM-7 or compatible (see Figure c).

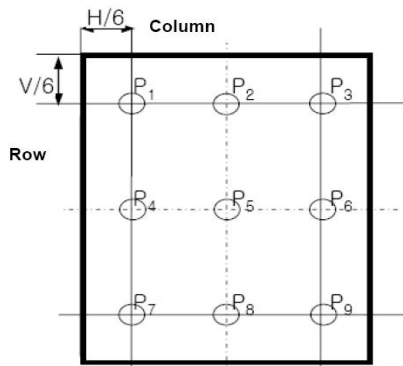

Figure b

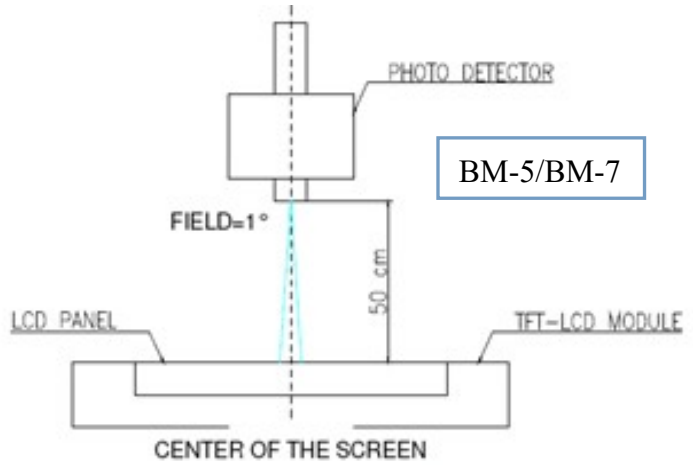
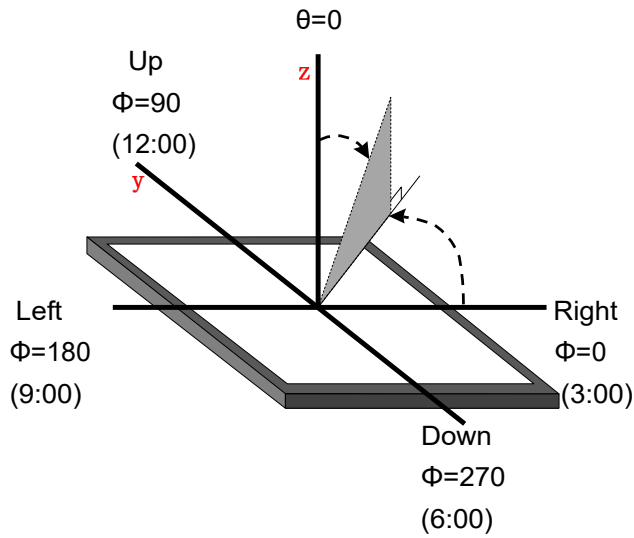

Figure c

FIG.3. The definition of viewing angle



8. Environmental / Reliability Tests

No	Test Item	Condition	Remarks
1	High Temperature Operation	Ts= +70°C, 96hrs	Note 1 IEC60068-2-2, GB2423. 2-89
2	Low Temperature Operation	Ta= -20°C, 96hrs	Note 2 IEC60068-2-1 GB2423.1-89
3	High Temperature Storage	Ta= +80°C, 96hrs	IEC60068-2-2 GB2423. 2-89
4	Low Temperature Storage	Ta= -30°C, 96hrs	IEC60068-2-1 GB/T2423.1-89
5	High Temperature & Humidity Storage	Ta= +60°C, 90% RH max, 96 hours	IEC60068-2-3 GB/T2423.3-2006
6	Thermal Shock (Non-operation)	-20°C 30 min ~ +60°C 30 min Change time: 5min, 30 Cycle	Start with cold temperature, end with high temperature IEC60068-2-14, GB2423.22-87
7	Electro Static Discharge (Operation)	C=150pF, R=330 Ω, 5 points/panel Air:±8KV, 5 times; Contact: ±4KV, 5 times; (Environment: 15°C ~ 35°C, 30% ~ 60%, 86Kpa ~ 106Kpa)	IEC61000-4-2 GB/T17626.2-1998
8	Vibration (Non-operation)	Frequency range: 10~55Hz, Stroke: 1.mm Sweep: 10Hz~55Hz~10Hz 2 hours for each direction of X .Y. Z. (package condition)	IEC60068-2-6 GB/T2423.5-1995
9	Shock (Non-operation)	60G 6ms, ± X, ±Y , ± Z 3 times for each direction	IEC60068-2-27 GB/T2423.5-1995
10	Package Drop Test	Height: 80 cm, 1 corner, 3 edges, 6 surfaces	IEC60068-2-32 GB/T2423.8-1995

Note: 1. Ts is the temperature of panel's surface.
2. Ta is the ambient temperature of sample.
3. The size of sample is 5pcs.

9. Mechanical Drawing

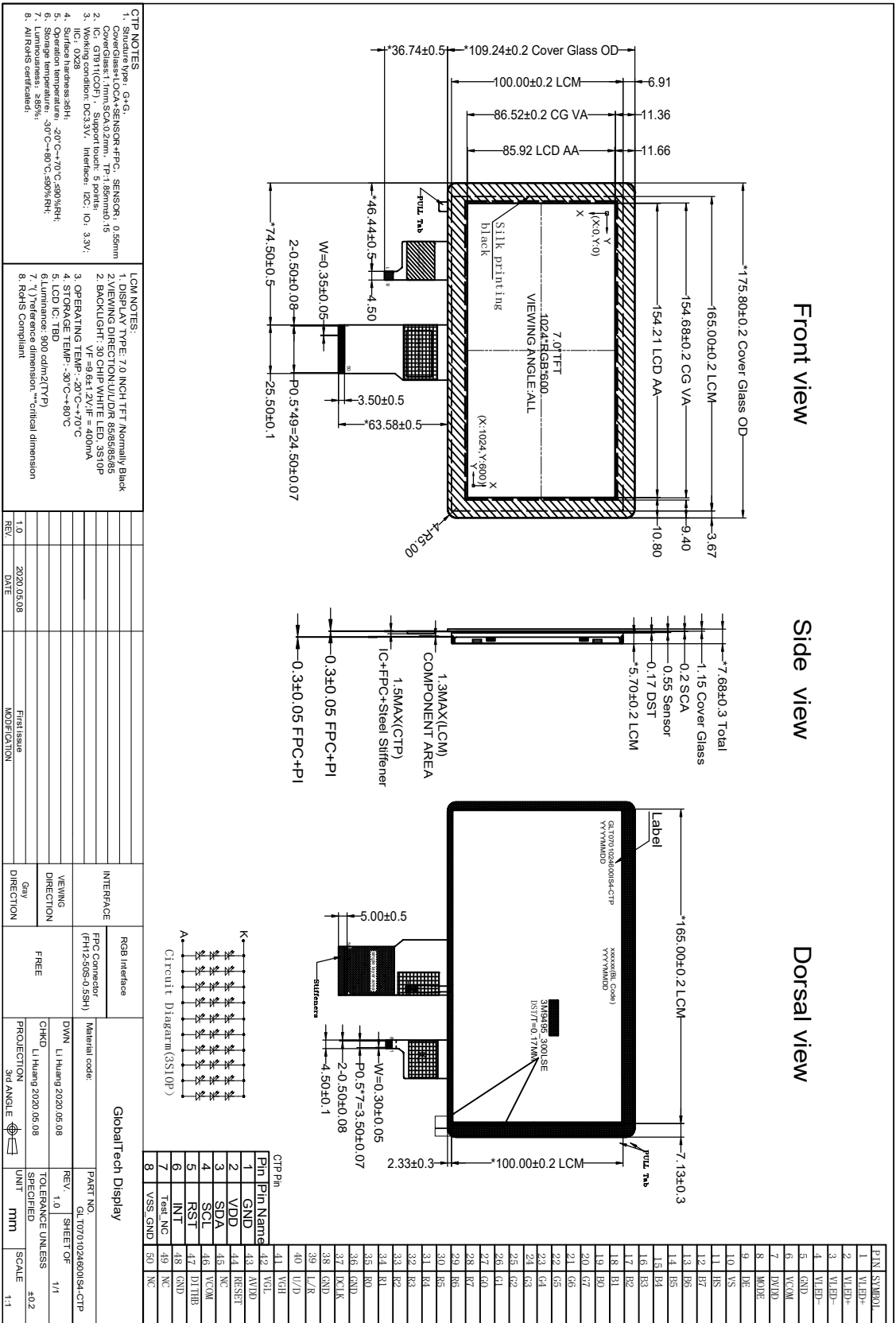

10. Packing

Packing Method

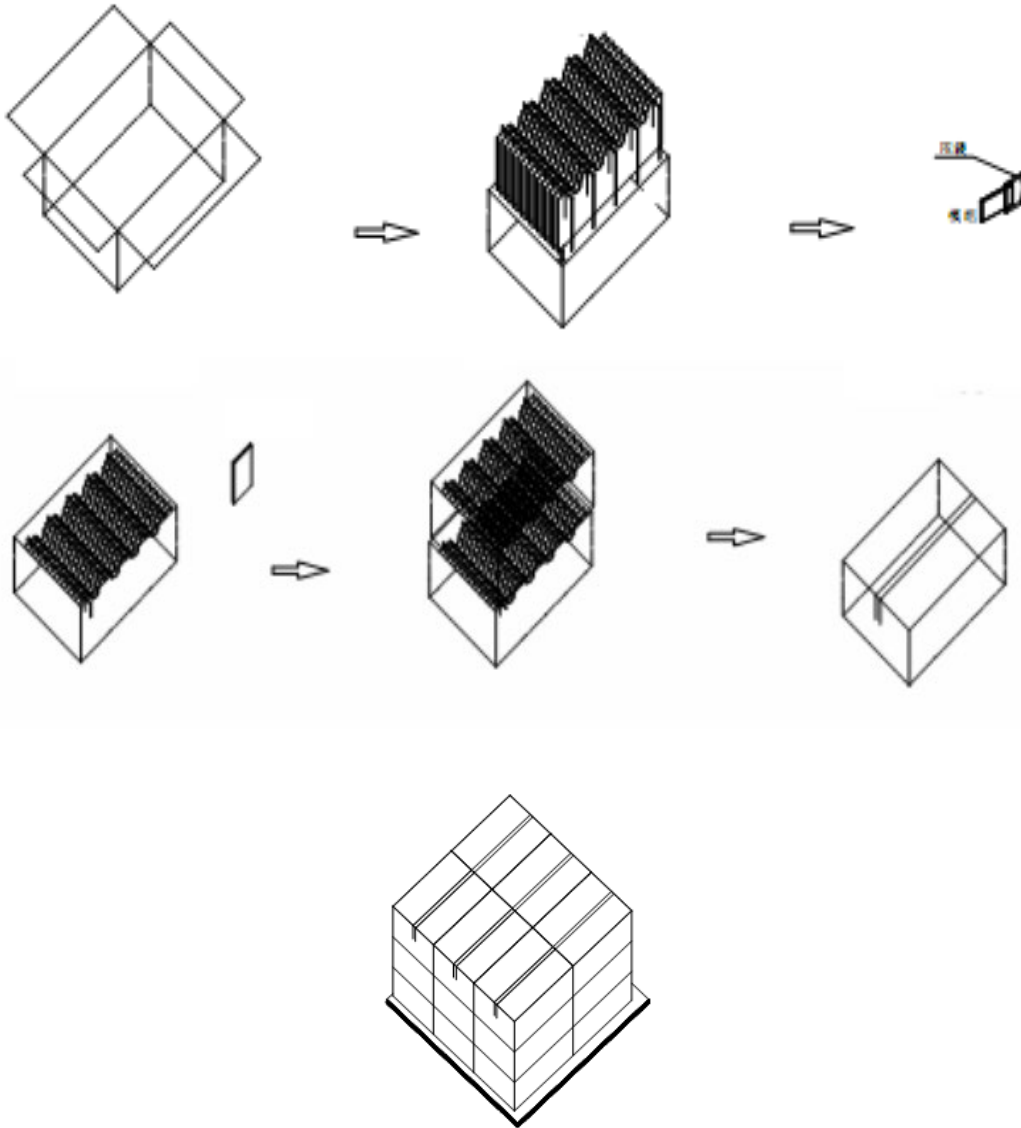

11. TFT-LCD Module Inspection Criteria

11.1 Objective

The TFT criterion is set to formalize the TFT quality standards with reference to customer for inspection.

11.2 Scope

The criterion is applicable to $5'' \leq S < 10''$ TFT products (Include TFT, TFT+RTP or TFT+CTP) manufactured by TFC.

11.3 Tools for Inspection

Tester, Calipers, Multi-meter, Anti-static wrist straps, Finger Cots, Desk Lamps, etc.

11.4 Sampling Plan and Reference Standards

11.4.1 Sampling plan:

Refer to GB/T2828.1-2012/ISO2859-1:1999 //MIL-STD-105E

AQL: level II; normal:

1) MA=0.40; 2) MI=0.65

11.4.2 IPC-A-610 Acceptability of Electronic Assemblies

11.5 Inspection Conditions and Inspection Reference

11.5.1 Cosmetic inspection with naked eyes:

- 1) Temperature: $23 \pm 5^\circ\text{C}$; relative humidity: 45~75%RH
- 2) Illumination: 500lux~1000lux
- 3) Distance: $30\text{cm} \pm 5$ from the inspector's naked eyes to the LCD panel.
- 4) View angle: within 45° from perpendicular to LCM surface (view direction and special parameters refer to production specification).

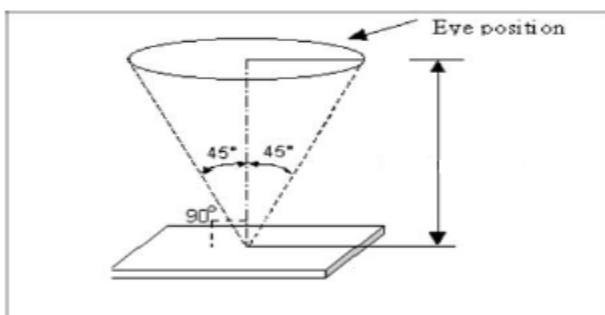

11.5.2 Definition

11.5.2.1 Area definition

A area: Active area (AA area)

B area: Viewing area (VA area)

C area: non-view area (out of B area)

11.5.2.2 Any cosmetic defect which do not affect product quality and customer assembling in C area, it's Acceptable. (The dimension is defined on the drawings)

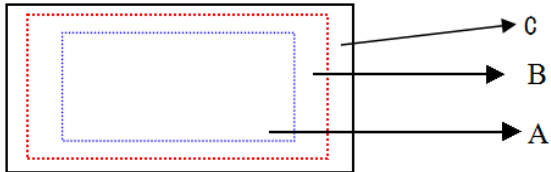

11.5.2.3 Test condition: refer to product specification

11.5.3 Defect type:

11.5.3.1 A area defect type:

Line defect (scratch, soft flocks, fiber), dot defect (white dot, black dot, same color dot, different color dot, bubble), stain, pin-hole, light leak, scratch.

11.5.3.2 B area defect type:

Broken, crack/chipping, FPC defect

11.5.4 Undefined items or other special items, refer to mutual agreement and limited sample by customer.

11.5.5 Test condition: refer to product specification.



11.6 Defects and Acceptance Standards

11.6.1 Appearance inspection

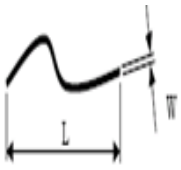
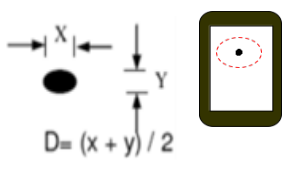
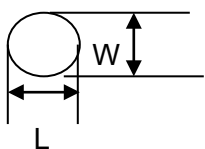
11.6.1.1 Dot/line defect

Defect	5≤S<10"	Accepted standard	MAX	MIN
S/C , line defect W:width L:length 	$W \leq 0.05\text{mm}$	Accept		√
	$0.05\text{mm} < W \leq 0.1\text{mm}$, $L \leq 8\text{mm}$ quantity ≤ 3 distance > 10mm	Accept		√
	$W > 0.1\text{mm}$ $L > 8\text{mm}$	Reject		√
Dot defect (black/white spot, foreign objects etc) D:Diameter 	$D \leq 0.15\text{mm}$	Accept		√
	$0.15\text{mm} < D \leq 0.30\text{mm}$ quantity ≤ 3 distance > 10mm	Accept		√
	$D > 0.30\text{mm}$	Reject		√
Polarizer with air bubble convex-concave dots or dent defect  $d = (w+l)/2$	$D \leq 0.20\text{mm}$	Accept		√
	$0.20\text{mm} < D \leq 0.5\text{mm}$ quantity ≤ 2	Accept		√
	$0.50\text{mm} < D \leq 0.8\text{mm}$ quantity ≤ 1	Accept		√
	$D > 0.8\text{mm}$	Reject		√

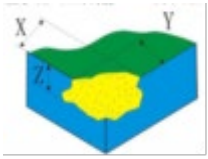
11.6.1.2 Chip and Crack

Defect	$5 \leq S < 10''$	Accepted standard	MAX	MIN
LENS chip 	X ≤ 0.3mm, Y ≤ 0.4mm, one side ≤ 1	Accept		√
	X > 0.3mm, Y > 0.4mm	Reject		√
Sensor chip	Not affect ITO line, not lengthen, function test is OK. And be non-visual after attaching Lens.	Accept		√
	Affect ITO line and be visual.	Reject		√
Glass crack 	Glass crack.	Reject		√

11.6.1.3 Attaching defect (kapton tape/protective film)

Defect	Description	Accepted standard	MAX	MIN
High temperature kapton tape	Kapton tape attached on FPC doesn't meet the criterion of drawing.	Reject		√
Protective film	Clean、 attaching flat、 no shifting	Accept		√

11.6.2 TFT defects and Inspection Criterion

11.6.2.1 Function items



Defects	Inspection Criterion	Pictures	Inspection method/tools	Defect category
No display /function	shows no picture/display in normal connected situation. ->Rejected		Naked eyes/ testers	MA
Missing segment	Shows missing lines in normal display.->Rejected		Naked eyes/ testers	MA

Image retention (sticking)	The previous picture stays in the next picture. Disappear time <10s, OK; time>10s, NG		Naked eyes/ testers	MA
Flicker	Not accepted	/	Naked eyes/ testers	MA
Display abnormal	Not accepted		Naked eyes/ testers	MA
Display dim/bright	Refer to bright value definition	/	Naked eyes/ BM-7	MA
Contrast	Refer to SPEC	/	Naked eyes/ BM-7	MA
White/ black dot White/ black speckle	Refer to dot criterion	/	Naked eyes	MI

11.6.2.2 LCD pixel defect (defect category: MI)

Item	Inspection criterion
Size	5≤S<10”
Pixel defect(RGB dot)	2
2 connected bright pixel dot	0
3 connected bright pixel dot or more	0
Bright pixel dot quantity	2
Random dark pixel dot quantity	3
2 connected pixel dark dot	1
3 connected pixel dark dot or more	0
Dark pixel dot quantity	4
Multi-bright pixel dot	ND 5% hidden, OK
<p>Remark: 2 bright pixel dots distance DS≥15mm 2 dark pixel dots distance DS≥5mm</p> <p>1) Bright pixel dot: Power on TFT and RGB dot in black display</p> <p>2) Dark pixel dot: Power on TFT and gray or black dot in RGB display</p> <p>3) Multi-bright pixel dot: Power on TFT and fluorescent tiny dot in black display(only visible in black display)</p>	

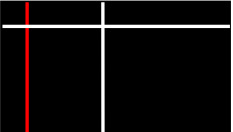
11.7 Others

11.7.1 Some defect items are not defined in this document, obey to final negotiation between customer and manufacturer or sign limit sample.

11.7.2 If the final goods include FPC/PCB, inspection criterion refers to IPC-610, Level 2.

12. Precautions for Use of LCD modules

12.1 Handling Precautions

- 12.1.1. The display panel is made of glass. Do not subject it to a mechanical shock by dropping it from a high place, etc.
- 12.1.2. If the display panel is damaged and the liquid crystal substance inside it leaks out, be sure not to get any in your mouth, if the substance comes into contact with your skin or clothes, promptly wash it off using soap and water.
- 12.1.3. Do not apply excessive force to the display surface or the adjoining areas since this may cause the color tone to vary.
- 12.1.4. The polarizer covering the display surface of the LCD module is soft and easily scratched. Handle this polarizer carefully.
- 12.1.5. If the display surface is contaminated, breathe on the surface and gently wipe it with a soft dry cloth. If still not completely clear, moisten cloth with one of the following solvents:
 - Isopropyl alcohol
 - Ethyl alcoholSolvents other than those mentioned above may damage the polarizer. Especially, do not use the following:
 - Water
 - Ketene
- 12.1.6. Do not attempt to disassemble the LCD Module.
- 12.1.7. If the logic circuit power is off, do not apply the input signals.
- 12.1.8. To prevent destruction of the elements by static electricity, be careful to maintain an optimum work environment.
 - 12.1.8.1. Be sure to ground the body when handling the LCD Modules.
 - 12.1.8.2. Tools required for assembly, such as soldering irons, must be properly ground.
 - 12.1.8.3. To reduce the amount of static electricity generated, do not conduct assembly and other work under dry conditions.
 - 12.1.8.4. The LCD Module is coated with a film to protect the display surface. Be care when peeling off this protective film since static electricity may be generated.

12.2 Storage Precautions

- 12.2.1. When storing the LCD modules, avoid exposure to direct sunlight or to the light of fluorescent lamps.
- 12.2.2. The LCD modules should be stored under the storage temperature range. If the LCD modules will be stored for a long time, the recommend condition is:
Temperature: 0°C ~ 40°C Relative humidity: ≤80%
- 12.2.3. The LCD modules should be stored in the room without acid, alkali and harmful gas.

12.3 Transportation Precautions

The LCD modules should be no falling and violent shocking during transportation, and also should avoid excessive press, water, damp and sunshine.