

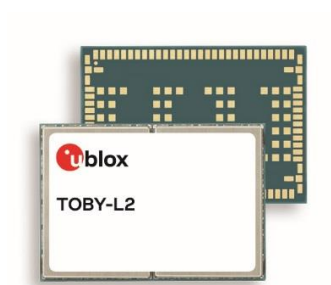

# TOBY-L2 series

Multi-mode LTE Cat 4 modules with HSPA+ and/or 2G  
fallback

Data sheet



## Abstract

Technical data sheet describing TOBY-L2 series multi-mode cellular modules. The modules are a complete and cost efficient LTE/3G/2G multi-mode solution offering up to 150 Mbit/s download and up to 50 Mbit/s upload data rate, covering up to six LTE bands, up to five WCDMA/DC-HSPA+ bands and up to four GSM/EGPRS bands in the compact TOBY form factor.

# Document information

<b>Title</b>	<b>TOBY-L2 series</b>	
<b>Subtitle</b>	Multi-mode LTE Cat 4 modules with HSPA+ and/or 2G fallback	
<b>Document type</b>	Data sheet	
<b>Document number</b>	UBX-13004573	
<b>Revision and date</b>	R33	30-Sep-2021
<b>Disclosure restriction</b>	C1-Public	

<b>Product status</b>	<b>Corresponding content status</b>	
<b>Functional sample</b>	Draft	For functional testing. Revised and supplementary data will be published later.
<b>In development / Prototype</b>	Objective specification	Target values. Revised and supplementary data will be published later.
<b>Engineering sample</b>	Advance information	Data based on early testing. Revised and supplementary data will be published later.
<b>Initial production</b>	Early production information	Data from product verification. Revised and supplementary data may be published later.
<b>Mass production / End of life</b>	Production information	Document contains the final product specification.

This document applies to the following products:

<b>Product name</b>	<b>Type number</b>	<b>Modem version</b>	<b>Application version</b>	<b>PCN reference</b>	<b>Product status</b>	
TOBY-L200	TOBY-L200-00S-00	09.71	A01.15	UBX-14044437	Obsolete	
	TOBY-L200-00S-01	09.71	A01.30	UBX-16026448	Obsolete	
	TOBY-L200-02S-00	15.90	A01.00	UBX-15029946	Obsolete	
	TOBY-L200-02S-01	15.90	A01.10	UBX-16031212	Obsolete	
	TOBY-L200-03S-00		15.90	A01.50	UBX-17022983	Obsolete
			15.90	A01.52	UBX-19058317	Obsolete
	TOBY-L200-03S-01		16.19	A01.02	UBX-19000820	Obsolete
			16.19	A01.04	UBX-19058317	End of life
	TOBY-L200-03S-02		17.00	A01.00	UBX-20033492	End of life
	TOBY-L200-03S-03		17.00	A01.01	UBX-21036626	Mass production
TOBY-L201	TOBY-L201-01S-00	09.93	A01.07	UBX-18012849	Obsolete	
		(for AT&T): 09.93 (for Verizon): 10.03	(for AT&T): A01.25 (for Verizon): A01.00	UBX-19058317	Obsolete	
	TOBY-L201-02S-00		(for AT&T): 09.93 (for Verizon): 09.94	(for AT&T): A02.50 (for Verizon): A01.02	UBX-17013932	Obsolete
			(for AT&T): 09.93 (for Verizon): 10.04	(for AT&T): A02.52 (for Verizon): A01.01	UBX-19058317	Obsolete
	TOBY-L201-02S-01		(for AT&T): 20.03 (for Verizon): 20.03	(for AT&T): A01.02 (for Verizon): A01.02	UBX-19000820	Obsolete
			(for AT&T): 20.03 (for Verizon): 20.04	(for AT&T): A01.04 (for Verizon): A01.00	UBX-19058317	Obsolete
	TOBY-L201-02S-02		20.06	A01.00	UBX-20036068	End of life
	TOBY-L201-02S-03		20.06	A01.01	UBX-21036626	Mass production

Product name	Type number	Modem version	Application version	PCN reference	Product status
TOBY-L210	TOBY-L210-00S-00	09.71	A01.15	UBX-14044437	Obsolete
	TOBY-L210-02S-00	15.63	A01.03	UBX-15029946	Obsolete
	TOBY-L210-02S-01	15.63	A01.10	UBX-16031212	Obsolete
	TOBY-L210-03S-00	15.63	A01.50	UBX-17022983	Obsolete
		15.63	A01.52	UBX-19058317	Obsolete
	TOBY-L210-03S-01	16.19	A01.02	UBX-19000820	Obsolete
		16.19	A01.04	UBX-19058317	End of life
	TOBY-L210-03S-02	17.00	A01.00	UBX-20033492	End of life
	TOBY-L210-03S-03	17.00	A01.01	UBX-21036626	Mass production
	TOBY-L210-03S-34	16.19	A01.03	UBX-19056311	Mass production
	TOBY-L210-60S-00	09.94	A01.00	UBX-15021694	Obsolete
	TOBY-L210-60S-01	09.94	A01.01	UBX-16005471	Obsolete
	TOBY-L210-62S-00	16.05	A01.02	UBX-19042394	Obsolete
		16.05	A01.05	UBX-19058317	Obsolete
	TOBY-L210-65S-00	16.05	A01.05	UBX-20009693	End of life
	TOBY-L210-65S-01	16.75	A01.00	UBX-20058840	Mass production
TOBY-L220	TOBY-L220-02S-00	15.93	A01.00	UBX-16025501	Obsolete
		15.93	A01.04	UBX-19058317	End of life
	TOBY-L220-02S-01	16.25	A01.00	UBX-20058840	Mass production
	TOBY-L220-62S-00	16.04	A01.00	UBX-17013073	Obsolete
		16.04	A01.02	UBX-19058317	End of life
TOBY-L220-62S-01	16.50	A01.00	UBX-20058840	Mass production	
TOBY-L280	TOBY-L280-02S-00	15.63	A01.03	UBX-15029946	Obsolete
	TOBY-L280-02S-01	15.63	A01.10	UBX-16031212	Obsolete
	TOBY-L280-03S-00	15.63	A01.50	UBX-17022983	Obsolete
		15.63	A01.52	UBX-19058317	Obsolete
	TOBY-L280-03S-01	16.19	A01.02	UBX-19000820	Obsolete
		16.19	A01.04	UBX-19058317	End of life
	TOBY-L280-03S-02	17.00	A01.00	UBX-20033492	End of life
TOBY-L280-03S-03	17.00	A01.01	UBX-21036626	Mass production	

u-blox or third parties may hold intellectual property rights in the products, names, logos and designs included in this document. Copying, reproduction, modification or disclosure to third parties of this document or any part thereof is only permitted with the express written permission of u-blox.

The information contained herein is provided "as is" and u-blox assumes no liability for its use. No warranty, either express or implied, is given, including but not limited to, with respect to the accuracy, correctness, reliability and fitness for a particular purpose of the information. This document may be revised by u-blox at any time without notice. For the most recent documents, visit [www.u-blox.com](http://www.u-blox.com).

Copyright © u-blox AG.

# Contents

<b>Document information</b> .....	<b>2</b>
<b>Contents</b> .....	<b>4</b>
<b>1 Functional description</b> .....	<b>6</b>
1.1 Overview.....	6
1.2 Product features .....	6
1.3 Block diagram .....	7
1.4 Product description .....	8
1.5 AT command support .....	9
1.6 Supported features .....	10
<b>2 Interfaces</b> .....	<b>12</b>
2.1 Power management .....	12
2.1.1 Module supply input (VCC) .....	12
2.1.2 RTC supply input / output (V_BCKP) .....	12
2.1.3 Generic digital interfaces supply output (V_INT) .....	12
2.2 Antenna interfaces.....	12
2.2.1 Antenna RF interfaces.....	12
2.2.2 Antenna detection.....	12
2.3 System functions.....	13
2.3.1 Module power-on .....	13
2.3.2 Module power-off.....	13
2.3.3 Module reset .....	13
2.3.4 Module configuration selection by host processor.....	13
2.4 SIM .....	14
2.4.1 SIM interface .....	14
2.4.2 SIM detection .....	14
2.5 Serial communication .....	14
2.5.1 UART interface.....	14
2.5.2 USB interface.....	15
2.5.3 DDC (I2C) interface.....	16
2.5.4 SDIO interface .....	16
2.6 Audio.....	16
2.7 GPIO .....	17
<b>3 Pin definition</b> .....	<b>18</b>
3.1 Pin assignment.....	18
<b>4 Electrical specifications</b> .....	<b>23</b>
4.1 Absolute maximum rating.....	23
4.1.1 Maximum ESD.....	23
4.2 Operating conditions.....	24
4.2.1 Operating temperature range.....	24
4.2.2 Supply/power pins .....	24
4.2.3 Current consumption.....	25
4.2.4 LTE RF characteristics .....	26

4.2.5	3G RF characteristics .....	27
4.2.6	2G RF characteristics .....	28
4.2.7	ANT_DET pin.....	28
4.2.8	PWR_ON pin.....	28
4.2.9	RESET_N pin.....	29
4.2.10	SIM pins .....	29
4.2.11	USB pins .....	29
4.2.12	Generic Digital Interface pins .....	30
4.2.13	DDC (I2C) pins.....	30
4.3	Parameters for ATEX applications .....	31
<b>5</b>	<b>Mechanical specifications .....</b>	<b>32</b>
<b>6</b>	<b>Qualification and approvals.....</b>	<b>33</b>
6.1	Reliability tests.....	33
6.2	Approvals.....	33
<b>7</b>	<b>Product handling &amp; soldering.....</b>	<b>34</b>
7.1	Packaging .....	34
7.1.1	Reels .....	34
7.1.2	Tapes.....	35
7.2	Moisture sensitivity levels.....	36
7.3	Reflow soldering .....	36
7.4	ESD precautions.....	36
<b>8</b>	<b>Default settings .....</b>	<b>37</b>
<b>9</b>	<b>Labeling and ordering information .....</b>	<b>38</b>
9.1	Product labeling.....	38
9.2	Explanation of codes .....	38
9.3	Ordering information.....	39
<b>Appendix</b>	<b>.....</b>	<b>40</b>
<b>Related documentation</b>	<b>.....</b>	<b>43</b>
<b>Revision history</b>	<b>.....</b>	<b>43</b>
<b>Contact</b>	<b>.....</b>	<b>45</b>

# 1 Functional description

## 1.1 Overview

The TOBY-L2 series comprises LTE/3G/2G multi-mode modules in the very small TOBY LGA form factor (152-pin, 35.6 x 24.8 mm) that are easy to integrate in compact designs.

TOBY-L2 series modules support up to six LTE bands, five UMTS/DC-HSPA+ bands and four GSM/(E)GPRS bands for voice and/or data transmission.

TOBY-L2 series modules are form-factor compatible with the other popular u-blox cellular module families: this allows customers to take the maximum advantage of their hardware and software investments and provides very short time-to-market.

With LTE category 4 data rates at up to 150 Mbit/s (downlink) and 50 Mbit/s (uplink), the modules are ideal for applications requiring the highest data-rates and high-speed internet access. TOBY-L2 series modules are the perfect choice for consumer fixed-wireless terminals, mobile routers and gateways, and applications requiring video streaming. They are also optimally suited for industrial (M2M) applications, such as remote access to video cameras, digital signage, telehealth, and security and surveillance systems.

## 1.2 Product features

Module	LTE	UMTS	GSM	Interfaces	Audio	Features	Grade
	LTE FDD category Bands	HSDPA category HSUPA category Bands	(E)GPRS multi-slot class Bands	UART USB 2.0 SDIO (Master) DDC (I2C) GPIOs	Analog audio Digital audio	Network indication Antenna supervisor MIMO 2x2/ Rx Diversity Embedded TCP/UDP stack Embedded HTTP,FTP FOTA Dual stack IPv4/IPv6	Standard Professional Automotive
TOBY-L200	4 2,4,5 7,17	24 6 1,2,4 5,8	12 Quad	◆ ● ◆ ◆ ◆	◆	● ◆ ● ◆ ◆ ◆ ●	● ●
TOBY-L201	4 2,4,5 13,17	24 6 2,5		● ● ◆ ◆		● ◆ ● ● ● ● ●	●
TOBY-L210 <sup>1</sup>	4 1,3,5 7,8,20	24 6 1,2 5,8	12 Quad	◆ ● ■ ■ ■	■	● ■ ● ■ ■ ■ ●	● ●
TOBY-L220 <sup>2</sup>	4 1,3,5 6,8,19	24 6 1,6 8,19		● ● ● ● ●	▲	● ● ● ● ● ● ●	●
TOBY-L280	4 1,3,5 7,8,28	24 6 1,2 5,8	12 Quad	● ● ● ● ●	●	● ● ● ● ● ● ●	● ●

● = supported by all product versions

■ = supported by all product versions except versions "00", "60"

◆ = supported by all product versions except versions "00", "01"

▲ = supported by all product versions except versions "62"

Table 1: TOBY-L2 series main features summary

<sup>1</sup> TOBY-L210-65S product version does not support LTE band 20

<sup>2</sup> TOBY-L220-62S product version does not support UMTS Radio Access Technology

## 1.3 Block diagram

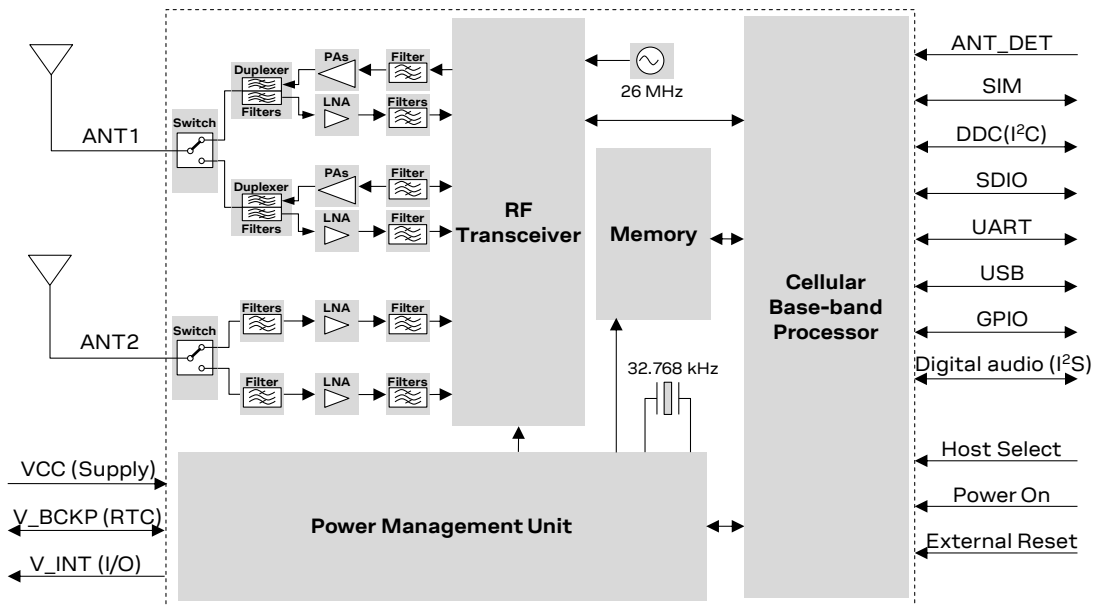

Figure 1: TOBY-L2 series block diagram

All the TOBY-L2 series modules product versions do not support the following interfaces, which should be left unconnected and should not be driven by external devices:

- VBUS USB detect (VUSB\_DET)
- Host Select functions

TOBY-L200-00S and TOBY-L210-00S modules, i.e. the “00” product versions, do not support the following interfaces, which should be left unconnected and should not be driven by external devices:

- UART interface
- SDIO interface
- DDC (I2C) interface
- I2S digital audio interface
- Antenna detection (ANT\_DET)
- General Purpose Inputs / Outputs (GPIO)

TOBY-L201-01S and TOBY-L210-60S modules, i.e. the “01” and “60” product versions, do not support the following interfaces, which should be left unconnected and not be driven by external devices:

- SDIO interface
- DDC (I2C) interface
- I2S digital audio interface
- Antenna detection (ANT\_DET)
- General Purpose Inputs / Outputs (GPIO)

TOBY-L201-02S modules do not support the following interfaces, which should be left unconnected and should not be driven by external devices:

- DDC (I2C) interface
- I2S digital audio interface

## 1.4 Product description

TOBY-L2 series modules provide 4G LTE, 3G WCDMA/DC-HSPA+, 2G GSM/(E)GPRS multi-mode technology:

- TOBY-L200 and TOBY-L201 are mainly designed for operation in America
- TOBY-L210 is mainly designed for operation in Europe, Asia, and other countries
- TOBY-L220 is mainly designed for operation in Japan
- TOBY-L280 is mainly designed for operation in south-east Asia and Oceania

4G LTE	3G UMTS/HSDPA/HSUPA	2G GSM/GPRS/EDGE
3GPP Release 9	3GPP Release 8	3GPP Release 8
Long Term Evolution (LTE)	Dual-Cell HS Packet Access (DC-HSPA+)	Enhanced Data rate GSM Evolution (EDGE)
Evolved UTRA (E-UTRA)	UMTS Terrestrial Radio Access (UTRA)	GSM EGPRS Radio Access (GERA)
Frequency Division Duplex (FDD)	Frequency Division Duplex (FDD)	Time Division Multiple Access (TDMA)
DL Multi-Input Multi-Output (MIMO) 2x2	DL Rx diversity	DL Advanced Rx Performance Phase 1
Band support <sup>3</sup> :	Band support:	Band support
<ul style="list-style-type: none"> <li>• TOBY-L200:               <ul style="list-style-type: none"> <li>• Band 17 (700 MHz)</li> <li>• Band 5 (850 MHz)</li> <li>• Band 4 (1700 MHz)</li> <li>• Band 2 (1900 MHz)</li> <li>• Band 7 (2600 MHz)</li> </ul> </li> <li>• TOBY-L201:               <ul style="list-style-type: none"> <li>• Band 17 (700 MHz)</li> <li>• Band 13 (750 MHz)</li> <li>• Band 5 (850 MHz)</li> <li>• Band 4 (1700 MHz)</li> <li>• Band 2 (1900 MHz)</li> </ul> </li> <li>• TOBY-L210<sup>4</sup>:               <ul style="list-style-type: none"> <li>• Band 20 (800 MHz)</li> <li>• Band 5 (850 MHz)</li> <li>• Band 8 (900 MHz)</li> <li>• Band 3 (1800 MHz)</li> <li>• Band 1 (2100 MHz)</li> <li>• Band 7 (2600 MHz)</li> </ul> </li> <li>• TOBY-L220:               <ul style="list-style-type: none"> <li>• Band 19 (850 MHz)</li> <li>• Band 6 (850 MHz)</li> <li>• Band 5 (850 MHz)</li> <li>• Band 8 (900 MHz)</li> <li>• Band 3 (1800 MHz)</li> <li>• Band 1 (2100 MHz)</li> </ul> </li> <li>• TOBY-L280:               <ul style="list-style-type: none"> <li>• Band 28 (750 MHz)</li> <li>• Band 5 (850 MHz)</li> <li>• Band 8 (900 MHz)</li> <li>• Band 3 (1800 MHz)</li> <li>• Band 1 (2100 MHz)</li> <li>• Band 7 (2600 MHz)</li> </ul> </li> </ul>	<ul style="list-style-type: none"> <li>• TOBY-L200:               <ul style="list-style-type: none"> <li>• Band 5 (850 MHz)</li> <li>• Band 8 (900 MHz)</li> <li>• Band 4 (AWS, i.e. 1700 MHz)</li> <li>• Band 2 (1900 MHz)</li> <li>• Band 1 (2100 MHz)</li> </ul> </li> <li>• TOBY-L201:               <ul style="list-style-type: none"> <li>• Band 5 (850 MHz)</li> <li>• Band 2 (1900 MHz)</li> </ul> </li> <li>• TOBY-L210:               <ul style="list-style-type: none"> <li>• Band 5 (850 MHz)</li> <li>• Band 8 (900 MHz)</li> <li>• Band 2 (1900 MHz)</li> <li>• Band 1 (2100 MHz)</li> </ul> </li> <li>• TOBY-L220<sup>5</sup>:               <ul style="list-style-type: none"> <li>• Band 19 (850 MHz)</li> <li>• Band 6 (850 MHz)</li> <li>• Band 8 (900 MHz)</li> <li>• Band 1 (2100 MHz)</li> </ul> </li> <li>• TOBY-L280:               <ul style="list-style-type: none"> <li>• Band 5 (850 MHz)</li> <li>• Band 8 (900 MHz)</li> <li>• Band 2 (1900 MHz)</li> <li>• Band 1 (2100 MHz)</li> </ul> </li> </ul>	<ul style="list-style-type: none"> <li>• TOBY-L200:               <ul style="list-style-type: none"> <li>• GSM 850 MHz</li> <li>• E-GSM 900 MHz</li> <li>• DCS 1800 MHz</li> <li>• PCS 1900 MHz</li> </ul> </li> <li>• TOBY-L210:               <ul style="list-style-type: none"> <li>• GSM 850 MHz</li> <li>• E-GSM 900 MHz</li> <li>• DCS 1800 MHz</li> <li>• PCS 1900 MHz</li> </ul> </li> <li>• TOBY-L280:               <ul style="list-style-type: none"> <li>• GSM 850 MHz</li> <li>• E-GSM 900 MHz</li> <li>• DCS 1800 MHz</li> <li>• PCS 1900 MHz</li> </ul> </li> </ul>

<sup>3</sup> TOBY-L2 series support all the E-UTRA channel bandwidths for each operating band according to 3GPP TS 36.521-1 [10].

<sup>4</sup> TOBY-L210-65S product version does not support LTE band 20

<sup>5</sup> TOBY-L220-62S product version does not support 3G Radio Access Technology



4G LTE	3G UMTS/HSDPA/HSUPA	2G GSM/GPRS/EDGE
<b>LTE Power Class</b> <ul style="list-style-type: none"> <li>Power Class 3 (23 dBm) for LTE mode</li> </ul>	<b>WCDMA/HSDPA/HSUPA Power Class</b> <ul style="list-style-type: none"> <li>Power Class 3 (24 dBm) for UMTS/HSDPA/HSUPA mode</li> </ul>	<b>GSM/GPRS (GMSK) Power Class</b> <ul style="list-style-type: none"> <li>Power Class 4 (33 dBm) for GSM/E-GSM bands</li> <li>Power Class 1 (30 dBm) for DCS/PCS bands</li> </ul> <b>EDGE (8-PSK) Power Class</b> <ul style="list-style-type: none"> <li>Power Class E2 (27 dBm) for GSM/E-GSM bands</li> <li>Power Class E2 (26 dBm) for DCS/PCS bands</li> </ul>
<b>Data rate</b> <ul style="list-style-type: none"> <li>LTE category 4: up to 150 Mbit/s DL, 50 Mbit/s UL</li> </ul>	<b>Data Rate</b> <ul style="list-style-type: none"> <li>TOBY-L200 / TOBY-L201:                             <ul style="list-style-type: none"> <li>HSDPA cat.14, up to 21 Mbit/s DL<sup>6</sup></li> <li>HSUPA cat.6, up to 5.6 Mbit/s UL</li> </ul> </li> <li>TOBY-L210 / TOBY-L220 / TOBY-L280                             <ul style="list-style-type: none"> <li>HSDPA cat.24, up to 42 Mbit/s DL</li> <li>HSUPA cat.6, up to 5.6 Mbit/s UL</li> </ul> </li> </ul>	<b>Data Rate<sup>7</sup></b> <ul style="list-style-type: none"> <li>GPRS multi-slot class 12<sup>8</sup>, CS1-4, up to 85.6 kbit/s DL/UL</li> <li>EDGE multi-slot class 12<sup>8</sup>, MCS1-9, up to 236.8 kbit/s DL/UL</li> </ul>

**Table 2: TOBY-L2 series LTE, 3G and 2G characteristics**

TOBY-L2 modules provide Circuit-Switched-Fall-Back (CSFB)<sup>9</sup> audio capability.

## 1.5 AT command support

The TOBY-L2 series modules support AT commands according to 3GPP standards TS 27.007 [7], TS 27.005 [8] and the u-blox AT command extensions.

 For the complete list of all supported AT commands and their syntax, see the u-blox AT commands manual [1].

The RIL (Radio Interface Layer) software for Android is available for TOBY-L2 series modules free of charge; see the Android RIL source code application note [3] for the supported software deliveries and more information.

<sup>6</sup> HSDPA category 24 capable

<sup>7</sup> GPRS/EDGE multi-slot class determines the number of timeslots available for upload and download and thus the speed at which data can be transmitted and received, with higher classes typically allowing faster data transfer rates.

<sup>8</sup> GPRS/EDGE multi-slot class 12 implies a maximum of 4 slots in Down-Link and 4 slots in Up-Link, with 5 slots in total.

<sup>9</sup> Not supported by "00", "01", "60", TOBY-L201-02S and TOBY-L220-62S product versions.

## 1.6 Supported features

Table 3 lists some of the main features supported by TOBY-L2 modules. For more details, see the TOBY-L2 / MPC-L2 series system integration manual [2] and the u-blox AT commands manual [1].

Feature	Description
Network indication <sup>10</sup>	GPIO configured to indicate the network status: registered home network, registered roaming, voice or data call enabled, no service. The feature can be enabled through the +UGPIOC AT command.
Antenna detection <sup>11</sup>	The <b>ANT_DET</b> pin provides antenna presence detection capability, evaluating the resistance from <b>ANT1</b> and <b>ANT2</b> pins to GND by means of an external antenna detection circuit implemented on the application board. The antenna supervisor (i.e. antenna detection) feature can be enabled through the +UANTR AT command.
Jamming detection <sup>12</sup>	Detects “artificial” interference that obscures the operator’s carriers entitled to give access to the radio service and reports the start and stop of such conditions to the application processor (AP). The feature can be enabled and configured through the +UCD AT command.
Embedded TCP and UDP stack <sup>13</sup>	Embedded TCP/IP and UDP/IP stack including direct link mode for TCP and UDP sockets. Sockets can be set in Direct Link mode to establish a transparent end to end communication with an already connected TCP or UDP socket via serial interface.
FTP <sup>13</sup> , FTPS <sup>14</sup>	File Transfer Protocol as well as Secure File Transfer Protocol (SSL encryption of FTP control channel) functionalities are supported via AT commands.
HTTP <sup>13</sup> , HTTPS <sup>14</sup>	Hyper-Text Transfer Protocol as well as Secure Hyper-Text Transfer Protocol (SSL encryption) functionalities are supported via AT commands. HEAD, GET, POST, DELETE and PUT operations are available.
Embedded TLS 1.2 <sup>14</sup>	With the support of X.509 certificates, Embedded TLS 1.2 provides server and client authentication, data encryption, data signature and enables TCP/IP applications like HTTPS and FTPS to communicate over a secured and trusted connection. The feature can be configured and enabled by +USECMNG and +USECPRF AT commands.
DNS <sup>13</sup>	Support for DNS functionality.
Dual stack IPv4/IPv6	Both Internet Protocol version 4 and Internet Protocol version 6 are supported in parallel.
BIP <sup>15</sup>	Bearer Independent Protocol for Over-the-Air SIM provisioning. The data transfer to/from the SIM uses either an already active PDP context or a new PDP context established with the APN provided by the SIM card.
Multiple PDP contexts	Up to 8 PDP contexts can be activated, and multi secondary contexts can be associated to a primary context.
SMS via IMS <sup>16</sup>	Allows SMS via embedded IP Multimedia Subsystem (IMS).
CSFB <sup>17</sup>	Circuit Switched Fall-Back (CSFB) feature allows voice service over circuit switched infrastructure (3G).
DTMF decoder <sup>17</sup>	During a voice call, the Dual-Tone Multi-Frequency detector analyses the RX speech (coming from the remote party). The detected DTMF symbols can be output via the related URC. For more details, see the +UDTMFD AT command.
Firmware update Over AT commands (FOAT)	Firmware module update over AT command interfaces (UART, USB). The feature can be enabled and configured through the +UFWUPD AT command.
Firmware update Over The Air (FOTA) <sup>13</sup>	Firmware module update over the LTE/3G/2G air interface. The feature can be enabled and configured through the +UFWINSTALL AT command.

<sup>10</sup> Wireless Wide Area Network status indication is permanently configured on **GPIO1** pin of “00”, “01” and “60” product versions

<sup>11</sup> Not supported by “00”, “01” and “60” product versions.

<sup>12</sup> Not supported by “00”, “01”, “02”, “03”, “60”, “62” and “65” product versions.

<sup>13</sup> Not supported by “00” and “60” product versions.

<sup>14</sup> Not supported by “00”, “01”, “60” and TOBY-L201-02S product versions.

<sup>15</sup> Not supported by “00”, “60” product versions. Not supported by TOBY-L201-01S and MPC-L201-01S module series, TOBY-L201-02S-00, MPC-L201-02S-00 in AT&T configuration.

<sup>16</sup> Not supported by “00”, “03”, “60”, “62”, “65”, TOBY-L200-02S, TOBY-L210-02S, TOBY-L220-02S, TOBY-L280-02S product versions

<sup>17</sup> Not supported by “00”, “01”, “60”, TOBY-L201-02S and TOBY-L220-62S product versions

Feature	Description
LTE DL MIMO 2x2 and 3G DL Rx Diversity	Improved cellular link quality and reliability on all operating bands.
Wi-Fi via modem <sup>18</sup>	<p>Full access to u-blox short range communication Wi-Fi modules is available through a dedicated SDIO interface. This means that from any host processor a single serial port can control the cellular module and the short range communication module.</p> <p>All the management software for the Wi-Fi module operations runs inside the cellular module in addition to those required for cellular-only operation: Wi-Fi driver, Web User Interface (WebUI), Connection Config Manager, Wi-Fi regional regulatory domains block feature.</p> <p>For more details, see the Wi-Fi / cellular integration application note <a href="#">[5]</a>.</p>
Smart Temperature Supervisor <sup>18</sup>	<p>Constant monitoring of the module board temperature:</p> <ul style="list-style-type: none"> <li>• Warning notification when the temperature approaches an upper or lower predefined threshold</li> <li>• Shutdown notified and forced when the temperature value is outside the specified range (shutdown suspended in case of an emergency call in progress)</li> </ul> <p>The Smart Temperature Supervisor feature can be enabled and configured through the +USTS AT command.</p> <p> The sensor measures board temperature, which can differ from ambient temperature.</p>
Remote SIM Access Profile (SAP) <sup>19</sup>	<p>Allows access and use of a remote (U)SIM card instead of the local SIM card directly connected to the module (U)SIM interface. The module acts as an SAP Client establishing a connection and performing data exchange to a SAP Server directly connected to the remote SIM. The modules provide a dedicated USB SAP channel and a dedicated multiplexer SAP channel over UART for communication with the remote (U)SIM card.</p> <p>The feature can be configured and enabled by +USAPMODE and +USAPIND AT commands.</p>
Power saving	<p>The power saving configuration is by default disabled, but it can be enabled and configured using the +UPSV AT command. When the power saving is enabled, the module automatically enters the low power idle-mode whenever possible, reducing current consumption.</p> <p>During idle-mode, the module processor core runs with the RTC 32 kHz reference clock, which is generated by the internal 32 kHz oscillator.</p>
Fast Dormancy	<p>The Fast Dormancy feature, defined in 3GPP Rel.8, allows reduction of current consumption and network utilization during periods of data inactivity. It can be activated and configured by +UFDAC and +UDCONF=61 AT commands.</p>
Radio Policy Manager (RPM) <sup>20</sup>	<p>The Radio Policy Manager (RPM) feature provides a more efficient access to the network, controlling the number of network accesses per service type over a fixed amount of time. For more details on the RPM feature see the GSMA IoT device connection efficiency guidelines <a href="#">[20]</a>.</p> <p>The feature can be enabled through the +URPM and +URPMCONF AT commands.</p>

**Table 3: Some of the main features supported by TOBY-L2 series modules**

<sup>18</sup> Not supported by "00", "01" and "60" product versions.

<sup>19</sup> Not supported by "00", "01", "02", "60", "62" and "65" product versions

<sup>20</sup> Not supported by product versions "00", "02", "60", "62" and "65" of TOBY-L2x0 modules, not supported by product version "01" of TOBY-L201 modules, and not supported by product versions TOBY-L2x0-03S-00 and TOBY-L201-02S-00

## 2 Interfaces

### 2.1 Power management

#### 2.1.1 Module supply input (VCC)

TOBY-L2 series modules must be supplied through the **VCC** pins by a DC power supply. Voltage must be stable, because during operation the current drawn from **VCC** can vary significantly, based on the power consumption profile of the LTE/3G/2G technologies (described in the TOBY-L2 / MPCI-L2 series system integration manual [\[2\]](#)).

#### 2.1.2 RTC supply input / output (V\_BCKP)

When **VCC** voltage is within the valid operating range, the internal Power Management Unit (PMU) supplies the Real Time Clock (RTC) and the same supply voltage is available on the **V\_BCKP** pin. If the **VCC** voltage is under the minimum operating limit (e.g. during not powered mode), the **V\_BCKP** pin can externally supply the RTC.

#### 2.1.3 Generic digital interfaces supply output (V\_INT)

TOBY-L2 series modules provide a 1.8 V supply rail output on the **V\_INT** pin, which is internally generated when the module is switched on. The same voltage domain is used internally to supply the generic digital interfaces of the modules. The **V\_INT** supply output can be used in place of an external discrete regulator.

### 2.2 Antenna interfaces

#### 2.2.1 Antenna RF interfaces

The modules have two RF pins with a characteristic impedance of 50  $\Omega$ . The primary antenna pin (**ANT1**) supports both Tx and Rx, providing the main antenna interface, while the secondary antenna pin (**ANT2**) supports Rx only for the LTE MIMO 2x2 and 3G Rx diversity configurations.

#### 2.2.2 Antenna detection

 The antenna detection is not supported by “00”, “01” and “60” product versions.

The **ANT\_DET** pin is an Analog to Digital Converter (ADC) input with a current source provided by TOBY-L2 modules to sense the antenna presence (as an optional feature). It evaluates the resistance from **ANT1** and **ANT2** pins to GND by means of an external antenna detection circuit implemented on the application board. For more details, see the TOBY-L2 / MPCI-L2 series system integration manual [\[2\]](#) and the u-blox AT commands manual [\[1\]](#).

## 2.3 System functions

### 2.3.1 Module power-on

TOBY-L2 series can be switched on in one of the following ways:

- Rising edge on the **VCC** pin to a valid voltage for module supply, i.e. applying module supply
- Low level on the **PWR\_ON** pin, which is normally set high by an internal pull-up, for a valid time period when the applied **VCC** voltage is within the valid operating range (see section 4.2.8). The **PWR\_ON** line should be driven by open drain, open collector or contact switch.
- Low level on the **RESET\_N** pin, which is normally set high by an internal pull-up, for a valid time period when the applied **VCC** voltage is within the valid operating range (see section 4.2.9). The **RESET\_N** line should be driven by open drain, open collector or contact switch.
- RTC alarm, i.e. pre-programmed scheduled time by AT+CALA command, when the applied **VCC** voltage is within the valid operating range

### 2.3.2 Module power-off

TOBY-L2 series can be properly switched off by:

- AT+CPWROFF command (see the u-blox AT commands manual [1]). The current parameter settings are saved in the module's non-volatile memory and a proper network detach is performed.

An abrupt under-voltage shutdown occurs on TOBY-L2 series modules when the **VCC** supply is removed. If this occurs, it is not possible to store the current parameter settings in the module's non-volatile memory or to perform the proper network detach.

An abrupt shutdown occurs on TOBY-L2 series modules when a low level is applied on the **RESET\_N** pin, which is normally set high by an internal pull-up, for a valid time period (see section 4.2.9). This causes an abrupt shutdown of the module: the current parameter settings are not saved in the module's non-volatile memory and a proper network detach is not performed.

An over-temperature or an under-temperature shutdown occurs on TOBY-L2 modules when the temperature measured within the cellular module reaches the dangerous area, if the optional Smart Temperature Supervisor feature is enabled and configured by the AT+USTS command (see the u-blox AT commands manual [1] and the TOBY-L2 / MPC1-L2 series system integration manual [2]).



Smart Temperature Supervisor is not supported by “00”, “01” and “60” product versions.

### 2.3.3 Module reset

TOBY-L2 series modules can be reset (rebooted) by:

- AT+CFUN command (see the u-blox AT commands manual [1]). This causes an “internal” or “software” reset of the module. The current parameter settings are saved in the module's non-volatile memory and a proper network detach is performed.

An abrupt “external” or “hardware” reset occurs when a low level is applied to the **RESET\_N** pin, which is normally set high by an internal pull-up, for a valid time period (see the section 4.2.9). This causes an “external” or “hardware” reset of the module. The current parameter settings are not saved in the module's non-volatile memory and a proper network detach is not performed. The **RESET\_N** line should be driven by open drain, open collector or contact switch.

### 2.3.4 Module configuration selection by host processor



The functionality of **HOST\_SELECT0** and **HOST\_SELECT1** pins is not supported.

TOBY-L2 series modules include two input pins (**HOST\_SELECT0**, **HOST\_SELECT1**) for the selection of the module configuration by the host application processor.

## 2.4 SIM

### 2.4.1 SIM interface

A SIM card interface is provided on the **VSIM**, **SIM\_IO**, **SIM\_CLK**, **SIM\_RST** pins: the high-speed SIM/ME interface is implemented as well as the automatic detection of the required SIM voltage. Both 1.8 V and 3 V SIM types are supported (1.8 V and 3 V ME). Activation and deactivation with automatic voltage switch from 1.8 V to 3 V is implemented, according to ISO-IEC 7816-3 specifications.

### 2.4.2 SIM detection

 The SIM detection is not supported by “00”, “01” and “60” product versions.

The modules provide the SIM detection function over GPIO to sense the SIM card physical presence (as optional feature) when the specific GPIO pin of the module is properly connected to the mechanical switch of the SIM card holder as illustrated in the TOBY-L2 / MPCI-L2 system integration manual [2].

## 2.5 Serial communication

TOBY-L2 series provides the following serial communication interfaces:

- UART interface: available for the communication with a DTE host application processor (AT commands, data communication, FW update by means of FOAT) and for diagnostic
- USB interface: High-Speed USB 2.0 compliant interface available for the communication with a USB host application processor (AT commands, data communication, FW update by means of the FOAT feature), for FW update by means of the u-blox EasyFlash tool and for diagnostic
- DDC interface: I2C bus compatible interface available to communicate with external I2C devices
- SDIO interface: Secure Digital Input Output interface available for the communication with an external u-blox short range communication Wi-Fi module

### 2.5.1 UART interface

 The UART interface is not supported by “00” modules product versions.

TOBY-L2 series modules include a 9-wire unbalanced asynchronous serial interface (UART) for communication with an application host processor (AT commands, data communication, FW update by means of the FOAT feature) and for diagnostic purpose.

The UART features are:

- Complete serial port with RS-232 functionality conforming to ITU-T V.24 recommendation [13], with CMOS compatible signal levels (0 V for low data bit or ON state and 1.8 V for high data bit or OFF state)
- Data lines (**RXD** output, **TXD** input), hardware flow control lines (**CTS** output, **RTS** input), modem status and control lines (**DTR** input, **DSR** output, **DCD** output, **RI** output) are provided
- Hardware flow control (default value), software flow control, or none flow control are supported

 Software flow control is not supported by “00”, “01”, “60” and TOBY-L201-02S product versions.

- Power saving indication available on the hardware flow control output (**CTS** line): the line is driven to the OFF state when the module is not prepared to accept data by the UART interface
- Power saving control over the **RTS** input or the **DTR** input can be enabled via AT+UPSV command (see u-blox AT commands manual [1] and TOBY-L2 / MPCI-L2 system integration manual [2])
- The following baud rates are supported: 9600, 19200, 38400, 57600, 115200 (default baud rate when autobauding is disabled or not supported), 230400, 460800 and 921600 bit/s

- One-shot autobauding is supported and it is by default enabled: automatic baud rate detection is performed only once, at module start up. After the detection, the module works at the fixed baud rate (the detected one) and the baud rate can only be changed via AT command (see the u-blox AT commands manual [1], +IPR).
- Frame format can be: 8N2, 8N1 (default frame configuration), 8E1, 8O1, 7N2, 7N1, 7E1, 7O1

 Automatic frame recognition is not supported by all TOBY-L2 series modules product versions.

UART serial interface can be conveniently configured through AT commands. For more details, see the u-blox AT commands manual [1] (+IPR, +ICF, +IFC, &K, \Q, +UPSV AT command) and the TOBY-L2 / MPCI-L2 series system integration manual [2].

### 2.5.1.1 Multiplexer protocol

The modules include multiplexer functionality as per 3GPP TS 27.010 [9] on the UART physical link.

This is a data link protocol which uses HDLC-like framing and operates between the module (DCE) and the application processor (DTE), allowing a number of simultaneous sessions over the physical link (UART): the user can concurrently use AT interface on one MUX channel and data communication on another MUX channel. The following virtual channels are defined (see the Mux application note [4]):

- Channel 0: control
- Channel 1 – 5: AT commands / data connection

### 2.5.2 USB interface

TOBY-L2 series modules include a high-speed USB 2.0 compliant interface with maximum 480 Mbit/s data rate, representing the main interface for transferring high speed data with a host application processor. The module itself acts as a USB device and can be connected to any USB host equipped with compatible drivers.

The **USB\_D+** / **USB\_D-** lines carry the USB data and signaling, providing all the functionalities for the bus attachment, configuration, enumeration, suspension or remote wakeup according to the USB 2.0 specification [14].

 The functionality of the additional **VUSB\_DET** pin is not supported by all the TOBY-L2 series modules product versions: the pin should be left unconnected or it should not be driven high by any external device, because a high logic level applied to the pin will represent a module switch-on event (additional to the ones listed in section 2.3.1) and will prevent reaching the minimum possible consumption with power saving enabled.

TOBY-L2 series modules provide by default the following set of USB functions:

- CDC-ACM modem: AT commands interface is available over this modem COM port
- RNDIS network adapter: Ethernet-over-USB connection is available over this network adapter

The USB of TOBY-L2 series modules can be configured by the AT+UUSBCONF command to select different sets of USB functions available in a mutually exclusive way. The configured USB profile can thus consist of a specific set of functions with various capabilities and purposes, such as:

- CDC-ACM for AT commands and data
- CDC-ACM for remote SIM Access Profile (SAP)
- CDC-ACM for diagnostic
- RNDIS for Ethernet-over-USB
- CDC-ECM for Ethernet-over-USB

 The CDC-ACM for remote SIM Access Profile (SAP) is not supported by the “00”, “01”, “02”, “60”, “62” and “65” product versions of TOBY-L2 series modules.

For more details regarding the USB configurations and capabilities, see the TOBY-L2 / MPC-L2 series system integration manual [2] and the u-blox AT commands manual [1], +UUSBCONF AT command.

USB drivers are available for the following operating system platforms:

- Windows Vista
- Windows 7
- Windows 8
- Windows 8.1
- Windows 10
- Windows Embedded CE 6.0<sup>21</sup>
- Windows Embedded Compact 7<sup>21</sup>
- Windows Embedded Compact 2013<sup>21</sup>

TOBY-L2 series modules are compatible with standard Linux/Android USB kernel drivers.

### 2.5.3 DDC (I2C) interface

 The DDC (I2C) interface is not supported by “00”, “01”, “60” and TOBY-L201-02S product versions.

TOBY-L2 series modules include an I2C-bus compatible DDC interface (**SDA**, **SCL**) available to communicate with external I2C devices as an audio codec: the TOBY-L2 module acts as an I2C master which can communicate with I2C slaves in accordance with the I2C bus specifications [16].

For more details regarding the DDC (I2C) interface usage, see the I2C AT commands description in the u-blox AT commands manual [1].

### 2.5.4 SDIO interface

 The SDIO interface is not supported by “00”, “01” and “60” modules product versions.

The modules include a 4-bit Secure Digital Input Output interface (**SDIO\_D0**, **SDIO\_D1**, **SDIO\_D2**, **SDIO\_D3**, **SDIO\_CLK**, **SDIO\_CMD**) designed to communicate with an external u-blox short range Wi-Fi module: the TOBY-L2 cellular module acts as an SDIO host controller which can communicate over the SDIO bus with a compatible u-blox short range Wi-Fi module acting as SDIO device.

The SDIO interface is the only one interface of TOBY-L2 cellular modules available for communication between the u-blox cellular module and the u-blox short range Wi-Fi module. The AT commands interface is not available on the SDIO interface of TOBY-L2 series modules.

The SDIO interface supports 50 MHz bus clock frequency, allowing a data throughput of 200 Mbit/s.

For more details regarding the SDIO interface usage and integration with u-blox Wi-Fi modules, see the TOBY-L2 / MPC-L2 series system integration manual [2], the Wi-Fi / cellular integration application note [5], and the Wi-Fi AT commands description in the u-blox AT commands manual [1].

## 2.6 Audio

 Audio is not supported by “00”, “01”, “60”, TOBY-L201-02S and TOBY-L220-62S product versions.

The modules include a 4-wire I2S digital audio interface (**I2S\_TXD**, **I2S\_RXD**, **I2S\_CLK**, **I2S\_WA**) that can be configured by AT command in PCM mode (short synchronization signal) or in normal I2S mode (long synchronization signal) to transfer digital audio data with an external device as an audio codec.

The modules act as an I2S master: **I2S\_CLK** clock and **I2S\_WA** world alignment / synchronization signal are generated by the module.

---

<sup>21</sup> For more details, see the Windows Embedded OS USB driver installation application note [15].



The modules provide master digital clock output function on **GPIO6** pin for an external audio codec.

For more details regarding TOBY-L2 series modules internal audio processing system capabilities, I2S digital audio interface possible configurations, usage and guideline for the integration with an external digital audio device as an audio codec, see the TOBY-L2 / MPCI-L2 series system integration manual [2] and the audio sections in the u-blox AT commands manual [1].

## 2.7 GPIO

 GPIOs are not supported by “00”, “01” and “60” modules product version except for the Wireless Wide Area Network status indication configured on the **GPIO1** pin.

 TOBY-L201-02S product versions do not support GPIO functions on the **DTR, DSR, DCD, RI** pins: only the related UART modem status and control functionalities are supported on these pins.

TOBY-L2 series modules include 14 pins (**GPIO1-GPIO6, I2S\_TXD, I2S\_RXD, I2S\_CLK, I2S\_WA, DTR, DSR, DCD, RI**) that can be configured as general purpose input/output or to provide custom functions as summarized in [Table 4](#) (for further details see the TOBY-L2 / MPCI-L2 series system integration manual [2] and the u-blox AT commands manual [1] +UGPIOC, +UGPIOR, +UGPIOW, +UGPS, +UGPRF AT commands).

Function	Description	Default GPIO	Configurable GPIOs
Network status indication	Network status: registered home network, registered roaming, data transmission, no service	--	All
SIM card detection	SIM card physical presence detection	GPIO5	GPIO5
SIM card hot insertion/removal	Enable / disable SIM interface upon detection of external SIM card physical insertion / removal	--	GPIO5
I2S digital audio interface <sup>22</sup>	I2S digital audio interface	I2S_RXD, I2S_TXD, I2S_CLK, I2S_WA	I2S_RXD, I2S_TXD, I2S_CLK, I2S_WA
Master clock output <sup>22</sup>	13 MHz / 26 MHz clock output for an external device as an audio codec	GPIO6	GPIO6
Wi-Fi enable	Enable/disable the supply of the external u-blox Wi-Fi module connected to the cellular module	GPIO1	All
DSR	UART data set ready output	DSR	DSR
DTR	UART data terminal ready input	DTR	DTR
DCD	UART data carrier detect output	DCD	DCD
RI	UART ring indicator output	RI	RI
General purpose input	Input to sense high or low digital level	--	All
General purpose output	Output to set the high or the low digital level	GPIO4	All
Pin disabled	Tri-state with an internal active pull-down enabled	GPIO2, GPIO3	All

**Table 4: GPIO custom functions configuration**

<sup>22</sup> Not supported by TOBY-L201-02S and TOBY-L220-62S product versions. On these product versions I2S\_RXD, I2S\_TXD, I2S\_CLK, I2S\_WA, GPIO6 are set by default as pin disabled.

## 3 Pin definition

### 3.1 Pin assignment

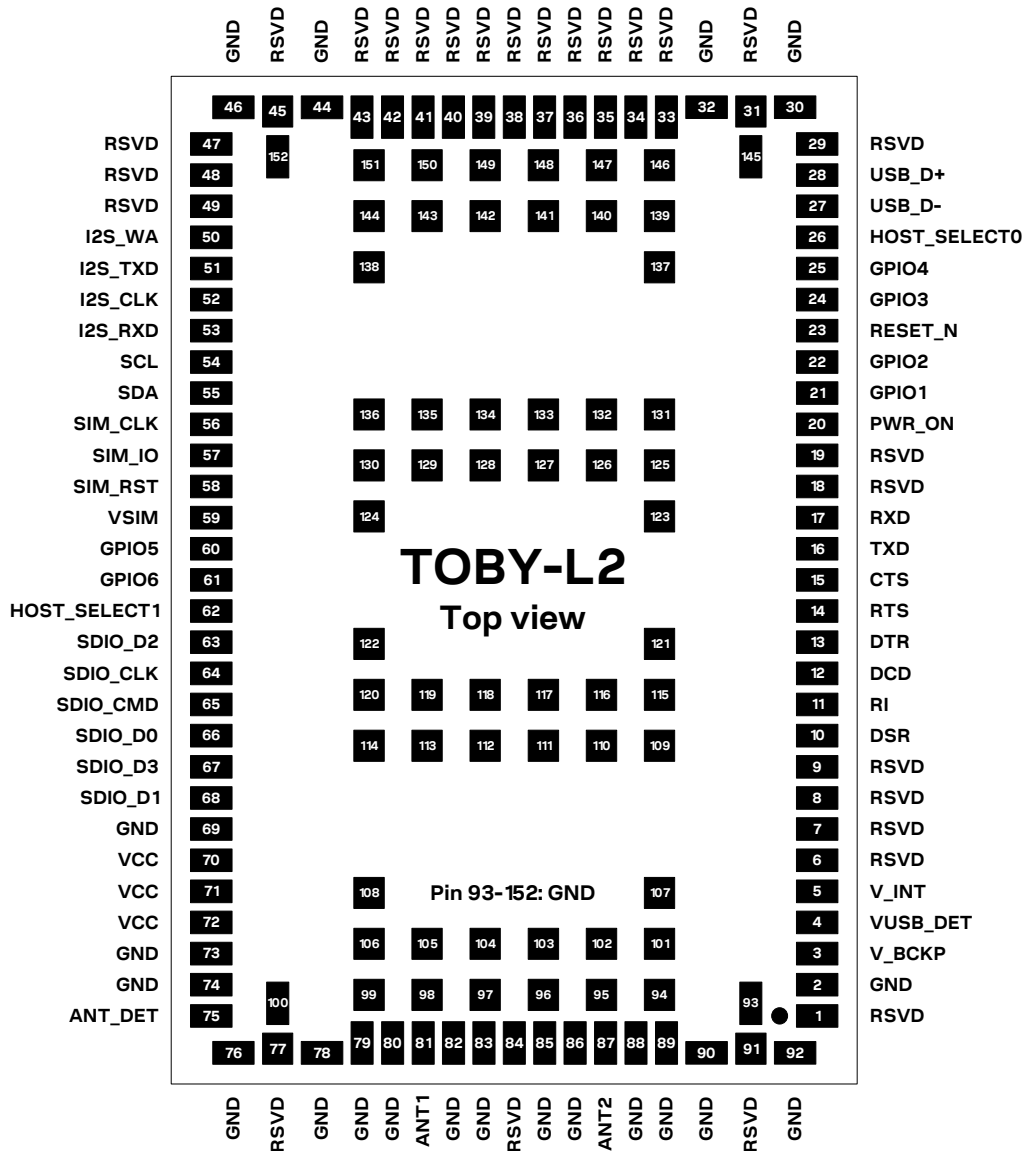

Figure 2: TOBY-L2 series pin assignment (top view)

No	Name	Power domain	I/O	Description	Remarks
1	RSVD	-	N/A	RESERVED pin	Leave unconnected.
2	GND	GND	N/A	Ground	All GND pins must be connected to ground.
3	V_BCKP	-	I/O	RTC supply Input/Output	3.0 V (typical) generated by the module when VCC supply voltage is within valid operating range. See section 4.2.2 for detailed electrical specs.
4	V_USB_DET	VBUS	I	VBUS USB detect input	Leave unconnected as VUSB_DET functionality is not supported by all the product versions.
5	V_INT	GDI	O	Generic Digital Interfaces supply output	1.8 V (typical) generated by the module when it is switched-on. See section 4.2.2 for detailed electrical specs.
6	RSVD	-	N/A	RESERVED pin	This pin has special function: it must be connected to GND to allow module to work properly.

No	Name	Power domain	I/O	Description	Remarks
7	RSVD	-	N/A	RESERVED pin	Leave unconnected.
8	RSVD	-	N/A	RESERVED pin	Leave unconnected.
9	RSVD	-	N/A	RESERVED pin	Leave unconnected.
10	DSR	GDI	O / I/O	UART data set ready / GPIO	<p>UART DSR not supported by '00' product versions; GPIO not supported by product versions '00', '01', '60', and TOBY-L201-02S.</p> <p>Circuit 107 (DSR) in ITU-T V.24, configurable as GPIO.</p> <p>PU/PD class H. Value at internal reset: T/PU.</p> <p>See section 4.2.12 for detailed electrical specs.</p>
11	RI	GDI	O / I/O	UART ring indicator / GPIO	<p>UART RI not supported by '00' product versions; GPIO not supported by product versions '00', '01', '60', and TOBY-L201-02S.</p> <p>Circuit 125 (RI) in ITU-T V.24, configurable as GPIO.</p> <p>PU/PD class H. Value at internal reset: T/PD.</p> <p>See section 4.2.12 for detailed electrical specs.</p>
12	DCD	GDI	O / I/O	UART data carrier detect / GPIO	<p>UART DCD not supported by '00' product versions; GPIO not supported by product versions '00', '01', '60', and TOBY-L201-02S.</p> <p>Circuit 109 (DCD) in ITU-T V.24, configurable as GPIO.</p> <p>PU/PD class H. Value at internal reset: T/PU.</p> <p>See section 4.2.12 for detailed electrical specs.</p>
13	DTR	GDI	I / I/O	UART data terminal ready / GPIO	<p>UART DTR not supported by '00' product versions; GPIO not supported by product versions '00', '01', '60', and TOBY-L201-02S.</p> <p>Circuit 108/2 (DTR) in ITU-T V.24, configurable as GPIO.</p> <p>Internal active pull-up to V_INT when set as DTR.</p> <p>PU/PD class H. Value at internal reset: T/PD.</p> <p>See section 4.2.12 for detailed electrical specs.</p>
14	RTS	GDI	I	UART ready to send	<p>UART RTS not supported by '00' product versions.</p> <p>Circuit 105 (RTS) in ITU-T V.24.</p> <p>Internal active pull-up to V_INT.</p> <p>PU/PD class H. Value at internal reset: T/PU.</p> <p>See section 4.2.12 for detailed electrical specs.</p>
15	CTS	GDI	O	UART clear to send	<p>UART CTS not supported by '00' product versions.</p> <p>Circuit 106 (CTS) in ITU-T V.24.</p> <p>PU/PD class H. Value at internal reset: T/PU.</p> <p>See section 4.2.12 for detailed electrical specs.</p>
16	TXD	GDI	I	UART data input	<p>UART TXD not supported by '00' product versions.</p> <p>Circuit 103 (TxD) in ITU-T V.24.</p> <p>Internal active pull-up to V_INT.</p> <p>PU/PD class M. Value at internal reset: T/PD.</p> <p>See section 4.2.12 for detailed electrical specs.</p>
17	RXD	GDI	O	UART data output	<p>UART RXD not supported by '00' product versions.</p> <p>Circuit 104 (RxD) in ITU-T V.24.</p> <p>PU/PD class M. Value at internal reset: T/PU.</p> <p>See section 4.2.12 for detailed electrical specs.</p>
18	RSVD	-	N/A	RESERVED pin	Leave unconnected.
19	RSVD	-	N/A	RESERVED pin	Leave unconnected.
20	PWR_ON	POS	I	Power-on input	<p>Internal active pull-up to VCC enabled.</p> <p>See section 4.2.8 for detailed electrical specs.</p>
21	GPIO1	GDI	I/O	GPIO	<p>GPIO not supported by '00', '01', '60' product versions, providing WWAN status indication on the GPIO1 pin.</p> <p>PU/PD class M. Value at internal reset: T/PD.</p> <p>See section 4.2.12 for detailed electrical specs.</p>
22	GPIO2	GDI	I/O	GPIO	<p>GPIO not supported by '00', '01', '60' product versions.</p> <p>PU/PD class M. Value at internal reset: T/PD.</p> <p>See section 4.2.12 for detailed electrical specs.</p>

No	Name	Power domain	I/O	Description	Remarks
23	RESET_N	ERS	I	External reset input	Internal active pull-up to VCC enabled. See section 4.2.9 for detailed electrical specs.
24	GPIO3	GDI	I/O	GPIO	GPIO not supported by '00', '01', '60' product versions. PU/PD class M. Value at internal reset: T/PD. See section 4.2.12 for detailed electrical specs.
25	GPIO4	GDI	I/O	GPIO	GPIO not supported by '00', '01', '60' product versions. PU/PD class M. Value at internal reset: T/PD. See section 4.2.12 for detailed electrical specs.
26	HOST_SELECT0	GDI	I	Input for the selection of module configuration by the host processor	Not supported all the product versions. PU/PD class M. Value at internal reset: T/PD. See section 4.2.12 for detailed electrical specs.
27	USB_D-	USB	I/O	USB Data Line D-	90 Ω nominal differential impedance Pull-up, pull-down and series resistors as required by the USB Revision 2.0 specification [14] are part of the USB pin driver and need not be provided externally. See section 4.2.11 for detailed electrical specs.
28	USB_D+	USB	I/O	USB Data Line D+	90 Ω nominal differential impedance Pull-up, pull-down and series resistors as required by the USB Revision 2.0 specification [14] are part of the USB pin driver and need not be provided externally. See section 4.2.11 for detailed electrical specs.
29	RSVD	-	N/A	RESERVED pin	Leave unconnected.
30	GND	GND	N/A	Ground	All GND pins must be connected to ground.
31	RSVD	-	N/A	RESERVED pin	Leave unconnected.
32	GND	GND	N/A	Ground	All GND pins must be connected to ground.
33	RSVD	-	N/A	RESERVED pin	Leave unconnected.
34	RSVD	-	N/A	RESERVED pin	Leave unconnected.
35	RSVD	-	N/A	RESERVED pin	Leave unconnected.
36	RSVD	-	N/A	RESERVED pin	Leave unconnected.
37	RSVD	-	N/A	RESERVED pin	Leave unconnected.
38	RSVD	-	N/A	RESERVED pin	Leave unconnected.
39	RSVD	-	N/A	RESERVED pin	Leave unconnected.
40	RSVD	-	N/A	RESERVED pin	Leave unconnected.
41	RSVD	-	N/A	RESERVED pin	Leave unconnected.
42	RSVD	-	N/A	RESERVED pin	Leave unconnected.
43	RSVD	-	N/A	RESERVED pin	Leave unconnected.
44	GND	GND	N/A	Ground	All GND pins must be connected to ground.
45	RSVD	-	N/A	RESERVED pin	Leave unconnected.
46	GND	GND	N/A	Ground	All GND pins must be connected to ground.
47	RSVD	-	N/A	RESERVED pin	Leave unconnected.
48	RSVD	-	N/A	RESERVED pin	Leave unconnected.
49	RSVD	-	N/A	RESERVED pin	Leave unconnected.
50	I2S_WA	GDI	O / I/O	I2S word alignment / GPIO	I2S not supported by product versions '00', '01', '60', TOBY-L201-02S and TOBY-L220-62S. GPIO not supported by product versions '00', '01', '60'. I2S word alignment, otherwise configurable as GPIO. PU/PD class M. Value at internal reset: T/PD. See section 4.2.12 for detailed electrical specs.
51	I2S_TXD	GDI	O / I/O	I2S transmit data / GPIO	I2S not supported by product versions '00', '01', '60', TOBY-L201-02S and TOBY-L220-62S. GPIO not supported by product versions '00', '01', '60'. I2S transmit data out, otherwise configurable as GPIO. PU/PD class M. Value at internal reset: T/PD. See section 4.2.12 for detailed electrical specs.

No	Name	Power domain	I/O	Description	Remarks
52	I2S_CLK	GDI	O/ I/O	I2S clock / GPIO	I2S not supported by product versions '00', '01', '60', TOBY-L201-02S and TOBY-L220-62S. GPIO not supported by product versions '00', '01', '60'. I2S serial clock, otherwise configurable as GPIO. PU/PD class M. Value at internal reset: T/PD. See section 4.2.12 for detailed electrical specs.
53	I2S_RXD	GDI	I/ I/O	I2S receive data / GPIO	I2S not supported by product versions '00', '01', '60', TOBY-L201-02S and TOBY-L220-62S. GPIO not supported by product versions '00', '01', '60'. I2S receive data in, otherwise configurable as GPIO. PU/PD class M. Value at internal reset: T/PD. See section 4.2.12 for detailed electrical specs
54	SCL	DDC	O	I2C bus clock line	I2C not supported by product versions '00', '01', '60' and TOBY-L201-02S. Fixed open drain. No internal pull-up. Value at internal reset: T. See section 4.2.13 for detailed electrical specs.
55	SDA	DDC	I/O	I2C bus data line	I2C not supported by product versions '00', '01', '60' and TOBY-L201-02S. Fixed open drain. No internal pull-up. Value at internal reset: T. See section 4.2.13 for detailed electrical specs.
56	SIM_CLK	SIM	O	SIM clock	See section 4.2.10 for detailed electrical specs.
57	SIM_IO	SIM	I/O	SIM data	Internal 4.7 kΩ pull-up resistor to VSIM. See section 4.2.10 for detailed electrical specs.
58	SIM_RST	SIM	O	SIM reset	See section 4.2.10 for detailed electrical specs.
59	VSIM	-	O	SIM supply output	VSIM = 1.8 V typical or 3.0 V typical generated by the module according to the SIM card/chip voltage type. See section 4.2.2 for detailed electrical specs.
60	GPIO5	GDI	I/O	GPIO	GPIO not supported by '00', '01', '60' product versions. PU/PD class M. Value at internal reset: T/PD. See section 4.2.12 for detailed electrical specs.
61	GPIO6	GDI	I/O	GPIO	GPIO not supported by '00', '01', '60' product versions. PU/PD class M. Value at internal reset: T/PD. See section 4.2.12 for detailed electrical specs.
62	HOST_SELECT1	GDI	I	Input for the selection of module configuration by the host processor	Not supported by all the product versions. PU/PD class M. Value at internal reset: T/PD. See section 4.2.12 for detailed electrical specs.
63	SDIO_D2	GDI	I/O	SDIO serial data [2]	SDIO not supported by '00', '01', '60' product versions. PU/PD class M. Value at internal reset: T/PD. See section 4.2.12 for detailed electrical specs.
64	SDIO_CLK	GDI	O	SDIO serial clock	SDIO not supported by '00', '01', '60' product versions. PU/PD class M. Value at internal reset: T/PD. See section 4.2.12 for detailed electrical specs.
65	SDIO_CMD	GDI	I/O	SDIO command	SDIO not supported by '00', '01', '60' product versions. PU/PD class M. Value at internal reset: T/PD. See section 4.2.12 for detailed electrical specs.
66	SDIO_D0	GDI	I/O	SDIO serial data [0]	SDIO not supported by '00', '01', '60' product versions. PU/PD class M. Value at internal reset: T/PD. See section 4.2.12 for detailed electrical specs.
67	SDIO_D3	GDI	I/O	SDIO serial data [3]	SDIO not supported by '00', '01', '60' product versions. PU/PD class M. Value at internal reset: T/PD. See section 4.2.12 for detailed electrical specs.
68	SDIO_D1	GDI	I/O	SDIO serial data [1]	SDIO not supported by '00', '01', '60' product versions. PU/PD class M. Value at internal reset: T/PD. See section 4.2.12 for detailed electrical specs.
69	GND	GND	N/A	Ground	All GND pins must be connected to ground.
70	VCC	VCC	I	Module supply input	All VCC pins must be connected to external supply. See sections 4.2.2 / 4.2.3 for detailed electrical specs.





No	Name	Power domain	I/O	Description	Remarks
71	VCC	VCC	I	Module supply input	All VCC pins must be connected to external supply. See sections 4.2.2 / 4.2.3 for detailed electrical specs.
72	VCC	VCC	I	Module supply input	All VCC pins must be connected to external supply. See sections 4.2.2 / 4.2.3 for detailed electrical specs.
73	GND	GND	N/A	Ground	All GND pins must be connected to ground.
74	GND	GND	N/A	Ground	All GND pins must be connected to ground.
75	ANT_DET	ADC	I	Antenna detection	Not supported by '00', '01', '60' product versions.
76	GND	GND	N/A	Ground	All GND pins must be connected to ground.
77	RSVD	-	N/A	RESERVED pin	Leave unconnected.
78	GND	GND	N/A	Ground	All GND pins must be connected to ground.
79	GND	GND	N/A	Ground	All GND pins must be connected to ground.
80	GND	GND	N/A	Ground	All GND pins must be connected to ground.
81	ANT1	ANT	I/O	Primary antenna	50 $\Omega$ nominal characteristic impedance. Main Tx / Rx antenna interface. See section 4.2.4 / 4.2.5 / 4.2.6 for details.
82	GND	GND	N/A	Ground	All GND pins must be connected to ground.
83	GND	GND	N/A	Ground	All GND pins must be connected to ground.
84	RSVD	-	N/A	RESERVED pin	Leave unconnected.
85	GND	GND	N/A	Ground	All GND pins must be connected to ground.
86	GND	GND	N/A	Ground	All GND pins must be connected to ground.
87	ANT2	ANT	I	Secondary antenna	50 $\Omega$ nominal characteristic impedance Rx only for Down-Link MIMO 2x2 and Rx diversity. See section 4.2.4 / 4.2.5 / 4.2.6 for details.
88	GND	GND	N/A	Ground	All GND pins must be connected to ground.
89	GND	GND	N/A	Ground	All GND pins must be connected to ground.
90	GND	GND	N/A	Ground	All GND pins must be connected to ground.
91	RSVD	-	N/A	RESERVED pin	Leave unconnected.
92	GND	GND	N/A	Ground	All GND pins must be connected to ground.
93-152	GND	GND	N/A	Ground	All GND pins must be connected to ground.

**Table 5: TOBY-L2 series pin-out**

 For more information about the pin-out, see the TOBY-L2 / MPC1-L2 series system integration manual [2].

 See appendix A for an explanation of abbreviations and terms used.

## 4 Electrical specifications

-  Stressing the device above one or more of the ratings listed in the Absolute Maximum Rating section may cause permanent damage. These are stress ratings only. Operating the module at these or at any conditions other than those specified in the Operating Conditions sections (section 4.2) of the specification should be avoided. Exposure to Absolute Maximum Rating conditions for extended periods may affect device reliability.
-  Operating condition ranges define those limits within which the functionality of the device is guaranteed.
-  Electrical characteristics are defined according to the verification on a representative number of samples or according to the simulation.
-  Where application information is given, it is advisory only and does not form part of the specification.

### 4.1 Absolute maximum rating

-  Limiting values given below are in accordance with Absolute Maximum Rating System (IEC 134).

Symbol	Description	Condition	Min.	Max.	Unit
VCC	Module supply voltage	Input DC voltage at VCC pin	-0.3	5.0	V
V_BCKP	RTC supply voltage	Input DC voltage at V_BCKP pin	-0.3	5.0	V
USB	USB D+/D- pins	Input DC voltage at USB interface pins		3.6	V
GDI	Generic digital interfaces	Input DC voltage at Generic digital interfaces pins		2.2	V
DDC	DDC interface	Input DC voltage at DDC interface pins		2.2	V
SIM	SIM interface	Input DC voltage at SIM interface pins	-0.3	3.6	V
ERS	External reset signal	Input DC voltage at RESET_N pin	-0.3	5.0	V
POS	Power-on input	Input DC voltage at PWR_ON pin	-0.3	5.0	V
Rho_ANT	Antenna ruggedness	Output RF load mismatch ruggedness at ANT pins		10:1	VSWR
Tstg	Storage Temperature		-40	85	°C

**Table 6: Absolute maximum ratings**

-  The product is not protected against overvoltage or reversed voltages. If necessary, voltage spikes exceeding the power supply voltage specification, given in the table above, must be limited to values within the specified boundaries by using appropriate protection devices.

#### 4.1.1 Maximum ESD

Parameter	Min	Typical	Max	Unit	Remarks
ESD sensitivity for all pins except ANT1 / ANT2 pins			1000	V	Human Body Model according to JESD22-A114
ESD sensitivity for ANT1 / ANT2 pins			1000	V	Human Body Model according to JESD22-A114
ESD immunity for ANT1 / ANT2 pins			4000	V	Contact Discharge according to IEC 61000-4-2
			8000	V	Air Discharge according to IEC 61000-4-2

**Table 7: Maximum ESD ratings**

-  u-blox cellular modules are Electrostatic Sensitive Devices and require special precautions when handling. See section 7.4 for ESD handling instructions.

## 4.2 Operating conditions

Unless otherwise indicated, all operating condition specifications are at an ambient temperature of +25 °C.

Operation beyond the operating conditions is not recommended and extended exposure beyond them may affect device reliability.

### 4.2.1 Operating temperature range

Parameter	Min.	Typical	Max.	Unit	Remarks
Normal operating temperature	-20	+25	+65	°C	Normal operating temperature range (fully functional and meet 3GPP specifications)
Extended operating temperature	-40		+85	°C	Extended operating temperature range (RF performance may be affected outside normal operating range, though module is fully functional)

Table 8: Environmental conditions

### 4.2.2 Supply/power pins

Symbol	Parameter	Min.	Typical	Max.	Unit
VCC	Module supply normal operating input voltage <sup>23</sup>	3.40	3.80	4.35	V
	Module supply extended operating input voltage <sup>24</sup>	3.20	3.80	4.35	V
V_BCKP	Real Time Clock supply input voltage	1.4		4.2	V
I_BCKP	Real Time Clock supply average current consumption, at V_BCKP = 1.8 V		2	5	µA

Table 9: Input characteristics of the Supply/Power pins

Symbol	Parameter	Min.	Typical	Max.	Unit
VSIM	SIM supply output voltage with 1.8 V external SIM	1.76	1.80	1.85	V
	SIM supply output voltage with 3.0 V external SIM	2.84	2.90	2.94	V
V_BCKP	Real Time Clock supply output voltage		3.00		V
I_BCKP	Real Time Clock supply output current capability			3	mA
V_INT	Generic Digital Interfaces supply output voltage	1.76	1.80	1.85	V
V_INT_RIPPLE	Generic Digital Interfaces supply output voltage ripple			45	mVpp
I_INT	Generic Digital Interfaces supply output current capability			70	mA

Table 10: Output characteristics of Supply/Power pins

<sup>23</sup> Input voltage at **VCC** must be above the normal operating range minimum limit to switch-on the module. RF performance may be affected when the input voltage at **VCC** drops below the herein stated normal operating range minimum limit, though module is still fully functional.

<sup>24</sup> Ensure that input voltage at **VCC** never drops below the extended operating range minimum limit during module operation: the cellular module may switch-off when the **VCC** voltage value drops below the herein stated extended operating range minimum limit.



### 4.2.3 Current consumption

Mode	Condition	Tx power	Min	Typ <sup>25</sup>	Max <sup>26</sup>	Unit
Power Off Mode	Averaged current value over any period, Module switched off			15		μA
Idle-Mode (Power Saving enabled by AT+UPSV, module in low power idle-mode, equivalent to +CFUN=4 or +COPS=2)	Averaged current value over a 100-ms period, USB not connected			1.1		mA
	Averaged current value over a 100-ms period, USB connected and suspended			1.3		mA
Cyclic Idle/Active-Mode (Power Saving enabled by AT+UPSV, Module registered with network)	Averaged current value over a 10-minute period, USB not connected			2.7		mA
	Averaged current value over a 10-minute period, USB connected and suspended			2.9		mA
Active-Mode (Power Saving disabled by AT+UPSV, Module registered with network)	Averaged current value over a 10-minute period, USB not connected			31		mA
	Averaged current value over a 10-minute period, USB connected and not suspended			48		mA
2G Connected Mode (Tx / Rx call enabled)	Pulse current <sup>27</sup> during a 1-slot GMSK Tx burst, 850/900 MHz bands	Maximum		1.9	2.5	A
	Averaged current value over a 10-second period, 2G GMSK call, 1 Tx + 1 Rx slot, 850/900 MHz	Maximum		275		mA
	Averaged current value over a 10-second period, 2G GMSK call, 1 Tx + 1 Rx slot, 1800/1900 MHz	Maximum		215		mA
3G Connected Mode (Tx / Rx call enabled)	Averaged current value over a 10-second period, 3G call with Low data rate	Minimum		185		mA
		0 dBm		200		mA
		12 dBm		275		mA
		18 dBm		380		mA
	Maximum		510		mA	
	Averaged current value over a 10-second period, 3G call with Maximum data rate	Maximum		590		mA
LTE Connected Mode (Tx / Rx call enabled)	Averaged current value over a 10-second period, LTE call with Low data rate	Minimum		295		mA
		0 dBm		310		mA
		12 dBm		390		mA
		18 dBm		490		mA
	Maximum		610		mA	
	Averaged current value over a 10-second period, LTE call with Maximum data rate	Maximum		660		mA

**Table 11: Module VCC current consumption**

<sup>25</sup> Typical values with a matched antenna.

<sup>26</sup> Maximum values with a mismatched antenna.

<sup>27</sup> It is recommended to use this figure to dimension maximum current capability of power supply.

#### 4.2.4 LTE RF characteristics

The LTE bands supported by each TOBY-L2 module are defined in [Table 2](#), while [Table 12](#) describes the Transmitting and Receiving frequencies for each LTE band according to 3GPP TS 36.521-1 [10].

Parameter		Min.	Max.	Unit	Remarks
Frequency range Band 17 (700 MHz)	Uplink	704	716	MHz	Module transmit
	Downlink	734	746	MHz	Module receive
Frequency range Band 13 (750 MHz)	Uplink	777	787	MHz	Module transmit
	Downlink	746	756	MHz	Module receive
Frequency range Band 28 (750 MHz)	Uplink	703	748	MHz	Module transmit
	Downlink	758	803	MHz	Module receive
Frequency range Band 20 (800 MHz)	Uplink	832	862	MHz	Module transmit
	Downlink	791	821	MHz	Module receive
Frequency range Band 19 (850 MHz)	Uplink	830	845	MHz	Module transmit
	Downlink	875	890	MHz	Module receive
Frequency range Band 6 (850 MHz)	Uplink	830	840	MHz	Module transmit
	Downlink	875	885	MHz	Module receive
Frequency range Band 5 (850 MHz)	Uplink	824	849	MHz	Module transmit
	Downlink	869	894	MHz	Module receive
Frequency range Band 8 (900 MHz)	Uplink	880	915	MHz	Module transmit
	Downlink	925	960	MHz	Module receive
Frequency range Band 4 (1700 MHz)	Uplink	1710	1755	MHz	Module transmit
	Downlink	2110	2155	MHz	Module receive
Frequency range Band 3 (1800 MHz)	Uplink	1710	1785	MHz	Module transmit
	Downlink	1805	1880	MHz	Module receive
Frequency range Band 2 (1900 MHz)	Uplink	1850	1910	MHz	Module transmit
	Downlink	1930	1990	MHz	Module receive
Frequency range Band 1 (2100 MHz)	Uplink	1920	1980	MHz	Module transmit
	Downlink	2110	2170	MHz	Module receive
Frequency range Band 7 (2600 MHz)	Uplink	2500	2570	MHz	Module transmit
	Downlink	2620	2690	MHz	Module receive

**Table 12: LTE operating RF frequency bands**

TOBY-L2 series modules include a UE Power Class 3 LTE transmitter (see [Table 2](#)), with output power and characteristics as per 3GPP TS 36.521-1 [10], and LTE receivers with characteristics compliant to 3GPP TS 36.521-1 [10], with LTE conducted receiver sensitivity performance described in [Table 13](#).

Parameter	Min.	Typical	Max.	Unit	Remarks
Receiver input sensitivity Band 17 (700 MHz)	-103.5			dBm	Channel bandwidth = 5 MHz
	-100.5			dBm	Channel bandwidth = 10 MHz
Receiver input sensitivity Band 13 (750 MHz)	-105.0			dBm	Channel bandwidth = 5 MHz
	-102.5			dBm	Channel bandwidth = 10 MHz
Receiver input sensitivity Band 28 (750 MHz)	-106.5			dBm	Channel bandwidth = 3 MHz
	-103.5			dBm	Channel bandwidth = 5 MHz
Receiver input sensitivity Band 20 (800 MHz)	-97.5			dBm	Channel bandwidth = 20 MHz
	-103.0			dBm	Channel bandwidth = 5 MHz
Receiver input sensitivity Band 19 (850 MHz)	-97.0			dBm	Channel bandwidth = 20 MHz
	-103.0			dBm	Channel bandwidth = 5 MHz
Receiver input sensitivity Band 5 (850 MHz)	-98.5			dBm	Channel bandwidth = 15 MHz
	-109.0			dBm	Channel bandwidth = 1.4 MHz
Receiver input sensitivity Band 8 (900 MHz)	-103.0			dBm	Channel bandwidth = 5 MHz
	-100.5			dBm	Channel bandwidth = 10 MHz
Receiver input sensitivity Band 7 (2600 MHz)	-110.0			dBm	Channel bandwidth = 1.4 MHz
	-104.5			dBm	Channel bandwidth = 5 MHz

Parameter	Min.	Typical	Max.	Unit	Remarks
Receiver input sensitivity Band 4 (1700 MHz)		-101.5		dBm	Channel bandwidth = 10 MHz
		-109.5		dBm	Channel bandwidth = 1.4 MHz
		-103.5		dBm	Channel bandwidth = 5 MHz
Receiver input sensitivity Band 3 (1800 MHz)		-98.0		dBm	Channel bandwidth = 20 MHz
		-110.0		dBm	Channel bandwidth = 1.4 MHz
		-104.5		dBm	Channel bandwidth = 5 MHz
Receiver input sensitivity Band 2 (1900 MHz)		-98.5		dBm	Channel bandwidth = 20 MHz
		-110.0		dBm	Channel bandwidth = 1.4 MHz
		-104.0		dBm	Channel bandwidth = 5 MHz
Receiver input sensitivity Band 1 (2100 MHz)		-98.0		dBm	Channel bandwidth = 20 MHz
		-104.5		dBm	Channel bandwidth = 5 MHz
		-98.5		dBm	Channel bandwidth = 20 MHz
Receiver input sensitivity Band 7 (2600 MHz)		-102.5		dBm	Channel bandwidth = 5 MHz
		-97.0		dBm	Channel bandwidth = 20 MHz

Condition: 50  $\Omega$  source, throughput > 95%, dual receiver, QPSK modulation, other settings as per 3GPP TS 36.521-1 [10]

**Table 13: LTE receiver sensitivity performance**

## 4.2.5 3G RF characteristics

The 3G bands supported by each TOBY-L2 module are defined in Table 2, while Table 14 describes the Transmitting and Receiving frequencies for each 3G band according to 3GPP TS 34.121-1 [11].

Parameter		Min.	Max.	Unit	Remarks
Frequency range Band 19 (850 MHz)	Uplink	830	845	MHz	Module transmit
	Downlink	875	890	MHz	Module receive
Frequency range Band 19 (850 MHz)	Uplink	830	845	MHz	Module transmit
	Downlink	875	890	MHz	Module receive
Frequency range Band 5 (850 MHz)	Uplink	824	849	MHz	Module transmit
	Downlink	869	894	MHz	Module receive
Frequency range Band 8 (900 MHz)	Uplink	880	915	MHz	Module transmit
	Downlink	925	960	MHz	Module receive
Frequency range Band 4 (AWS, 1700 MHz)	Uplink	1710	1755	MHz	Module transmit
	Downlink	2110	2155	MHz	Module receive
Frequency range Band 2 (1900 MHz)	Uplink	1850	1910	MHz	Module transmit
	Downlink	1930	1990	MHz	Module receive
Frequency range Band 1 (2100 MHz)	Uplink	1920	1980	MHz	Module transmit
	Downlink	2110	2170	MHz	Module receive

**Table 14: 3G operating RF frequency bands**

TOBY-L2 series modules include a UE Power Class 3 3G transmitter (see Table 2), with output power and characteristics as per 3GPP TS 34.121-1 [11], and 3G receivers with characteristics compliant to 3GPP TS 34.121-1 [11], with 3G conducted receiver sensitivity performance described in Table 15.

Parameter	Min.	Typical	Max.	Unit	Remarks
Receiver input sensitivity Band 5 (850 MHz)		-112.0		dBm	Downlink RF level for RMC @ BER < 0.1 %
Receiver input sensitivity Band 8 (900 MHz)		-112.0		dBm	Downlink RF level for RMC @ BER < 0.1 %
Receiver input sensitivity Band 4 (AWS, 1700 MHz)		-111.0		dBm	Downlink RF level for RMC @ BER < 0.1 %
Receiver input sensitivity Band 2 (1900 MHz)		-111.0		dBm	Downlink RF level for RMC @ BER < 0.1 %
Receiver input sensitivity Band 1 (2100 MHz)		-111.0		dBm	Downlink RF level for RMC @ BER < 0.1 %

Condition: 50  $\Omega$  source, other settings as per 3GPP TS 34.121-1 [11]

**Table 15: 3G receiver sensitivity performance**

## 4.2.6 2G RF characteristics

The 2G bands supported by each TOBY-L2 module are defined in [Table 2](#), while the [Table 16](#) describes the Transmitting and Receiving frequencies for each 2G band according to 3GPP TS 51.010-1 [\[12\]](#).

Parameter		Min.	Max.	Unit	Remarks
Frequency range GSM 850	Uplink	824	849	MHz	Module transmit
	Downlink	869	894	MHz	Module receive
Frequency range E-GSM 900	Uplink	880	915	MHz	Module transmit
	Downlink	925	960	MHz	Module receive
Frequency range DCS 1800	Uplink	1710	1785	MHz	Module transmit
	Downlink	1805	1880	MHz	Module receive
Frequency range PCS 1900	Uplink	1850	1910	MHz	Module transmit
	Downlink	1930	1990	MHz	Module receive

**Table 16: 2G operating RF frequency bands**

TOBY-L2 series modules include a GMSK Power Class 4 transmitter for GSM/E-GSM bands, GMSK Power Class 1 transmitter for DCS/PCS bands, 8-PSK Power Class E2 transmitter for all 2G bands (see [Table 2](#)), with output power and characteristics according to 3GPP TS 51.010-1 [\[12\]](#).

TOBY-L2 series modules 2G receiver characteristics are compliant to 3GPP TS 51.010-1 [\[12\]](#), with conducted receiver sensitivity performance described in [Table 17](#).

Parameter	Min.	Typical	Max.	Unit	Remarks
Receiver input sensitivity GSM 850 / E-GSM 900		-110.0		dBm	Downlink RF level @ BER Class II < 2.4 %
Receiver input sensitivity DCS 1800 / PCS 1900		-109.0		dBm	Downlink RF level @ BER Class II < 2.4 %

Condition: 50  $\Omega$  source, other settings as per 3GPP TS 51.010-1 [\[12\]](#)

**Table 17: 2G receiver sensitivity performance**

## 4.2.7 ANT\_DET pin



Antenna detection (**ANT\_DET**) is not supported by “00”, “01” and “60” product versions.

Parameter	Min.	Typical	Max.	Unit	Remarks
Output DC current pulse value		21		$\mu$ A	Generated by means of AT+UANTR command
Output DC current pulse time length		3.6		ms	Generated by means of AT+UANTR command

**Table 18: ANT\_DET pin characteristics**

## 4.2.8 PWR\_ON pin

Parameter	Min.	Typical	Max.	Unit	Remarks
Internal supply for PWR_ON Input Signal		3.8		V	Module supply input (VCC)
Low-level input	0		0.3*VCC	V	
High-level input	0.7*VCC		VCC	V	
Pull-up resistance	35	50		k $\Omega$	Internal active pull-up to VCC
Low-level input current		-76		$\mu$ A	
PWR_ON low time	5			ms	Low time to trigger a switch-on of the module

**Table 19: PWR\_ON pin characteristics**

### 4.2.9 RESET\_N pin

Parameter	Min.	Typical	Max.	Unit	Remarks
Internal supply for RESET_N Input Signal		3.8		V	Module supply input (VCC)
Low-level input	0		0.3*VCC	V	
High-level input	0.7*VCC		VCC	V	
Pull-up resistance	35	50		kΩ	Internal active pull-up to VCC
Low-level input current		-76		μA	
RESET_N low time	18		800	ms	Low time to trigger a switch-on of the module
	2.1		15	s	Low time to trigger a reset (reboot) of the module
	16			s	Low time to trigger an abrupt switch-off of the module

Table 20: RESET\_N pin characteristics

### 4.2.10 SIM pins

The SIM pins are a dedicated interface to the external SIM card/chip. The electrical characteristics fulfill regulatory specification requirements. The values in Table 21 are for information only.

Parameter	Min.	Typical	Max.	Unit	Remarks
Low-level input	-0.30		0.63	V	VSIM = 1.8 V
	-0.30		0.80	V	VSIM = 3.0 V
High-level input	1.17		2.10	V	VSIM = 1.8 V
	2.00		3.30	V	VSIM = 3.0 V
Low-level output		0.00	0.45	V	VSIM = 1.8 V, Max value at I <sub>OL</sub> = +2.0 mA
		0.00	0.40	V	VSIM = 3.0 V, Max value at I <sub>OL</sub> = +2.0 mA
High-level output	1.35	1.80		V	VSIM = 1.8 V, Min value at I <sub>OH</sub> = -2.0 mA
	2.60	2.90		V	VSIM = 3.0 V, Min value at I <sub>OH</sub> = -2.0 mA
Input / Output leakage current	-500		500	nA	0 V < V <sub>IN</sub> < 0.63 V or 1.17 V < V <sub>IN</sub> < 2.10 V 0 V < V <sub>IN</sub> < 0.80 V or 2.00 V < V <sub>IN</sub> < 3.30 V
Clock frequency on SIM_CLK		3.43		MHz	
Internal pull-up resistor on SIM_IO		4.7		kΩ	Internal pull-up to VSIM supply

Table 21: SIM pin characteristics

### 4.2.11 USB pins

USB data lines (USB\_D+ / USB\_D-) are compliant to the USB 2.0 high-speed specification. See the Universal Serial Bus revision 2.0 specification [14] for the detailed electrical characteristics.

Parameter	Min.	Typical	Max.	Unit	Remarks
High-speed squelch detection threshold (input differential signal amplitude)		100	150	mV	
High speed disconnect detection threshold (input differential signal amplitude)		525	625	mV	
High-speed data signaling input common mode voltage range		-50	500	mV	
High-speed idle output level		-10	10	mV	
High-speed data signaling output high level		360	440	mV	
High-speed data signaling output low level		-10	10	mV	
Chirp J level (output differential voltage)		700	1100	mV	
Chirp K level (output differential voltage)		-900	-500	mV	

Table 22: USB pins characteristics

## 4.2.12 Generic Digital Interface pins

Parameter	Min	Typical	Max	Unit	Remarks
Internal supply for GDI domain		1.80		V	Digital I/O Interfaces supply (V_INT)
Low-level input	-0.30		0.63	V	
High-level input	1.17		2.10	V	
Low-level output		0.00	0.45	V	Max value at I <sub>OL</sub> = +2.0 mA
High-level output	1.35	1.80		V	Min value at I <sub>OH</sub> = -2.0 mA
Input/output leakage current	-500		500	nA	0 V < V <sub>IN</sub> < 0.63 V or 1.17 V < V <sub>IN</sub> < 2.10 V
Internal active pull-up resistance	30		130	kΩ	Pull-Up class H
	30		180	kΩ	Pull-Up class M
Internal active pull-down resistance	30		150	kΩ	Pull-Down class H
	30		180	kΩ	Pull-Down class M

Table 23: GDI pin characteristics

### 4.2.12.1 AC characteristics of I2S pins

The I2S digital audio interface is not supported by the “00”, “01”, “60”, TOBY-L201-02S and TOBY-L220-62S product versions

Parameter	Description	Min	Typical	Max	Unit	Remarks
T1	I2S_WA period		125		μs	<I2S_sample_rate>=0
			62.5		μs	<I2S_sample_rate>=3
1/T1	I2S_WA frequency		8		kHz	<I2S_sample_rate>=0
			16		kHz	<I2S_sample_rate>=3
T2	I2S_CLK period		1/32		T1	CLK period = WA period / 32
1/T2	I2S_CLK frequency		32		1/T1	CLK frequency = 32 x WA frequency
T3	I2S_CLK high / low level pulse width	0.4		0.6	T2	
T4	I2S_TX valid before I2S_CLK edge	0.1			T2	
T5	I2S_TX valid after I2S_CLK edge	0.1			T2	
T6	I2S_WA valid before I2S_CLK edge	0.22			T2	
T7	I2S_WA valid after I2S_CLK edge	0.15			T2	
T8	I2S_RX setup time before I2S_CLK edge	0.19			T2	
T9	I2S_RX hold time after I2S_CLK edge	0.09			T2	

Table 24: I2S pins AC characteristics

### 4.2.13 DDC (I2C) pins

The DDC (I2C) interface is not supported by “00”, “01”, “60” and TOBY-L201-02S product versions.

DDC (I2C) lines (**SCL** and **SDA**) are compliant to the I2C-bus standard mode specification. See the I2C-bus specification [16] for the detailed electrical characteristics.

Parameter	Min	Typical	Max	Unit	Remarks
Internal supply for GDI domain		1.80		V	Digital I/O Interfaces supply (V_INT)
Low-level input	-0.30		0.63	V	
High-level input	1.17		2.10	V	
Low-level output		0.00	0.45	V	Max value at I <sub>OL</sub> = +2.0 mA
Input/output leakage current	-500		500	nA	0 V < V <sub>IN</sub> < 0.63 V or 1.17 V < V <sub>IN</sub> < 2.10 V
Clock frequency on SCL		100		kHz	

Table 25: DDC (I2C) pins characteristics

### 4.3 Parameters for ATEX applications

This section provides useful parameters and information to integrate TOBY-L2 series modules in applications intended for use in areas with potentially explosive atmospheres (ATEX), describing:

- Total internal capacitance and inductance of TOBY-L2 series modules (see [Table 26](#))
- Maximum RF output power at the antenna (**ANT1**) pin of TOBY-L2 series modules (see [Table 27](#))

 Any specific applicable requirement for the implementation of the apparatus integrating the TOBY-L2 series modules, intended for use in potentially explosive atmospheres, must be fulfilled according to the exact applicable standards: check the detailed requisites on the pertinent normative for the application, as for example the IEC 60079-0 [\[17\]](#), IEC 60079-11 [\[18\]](#), and IEC 60079-26 [\[19\]](#) standards.

 The certification of the application device that integrates a TOBY-L2 series module and the compliance of the application device with all the applicable certification schemes, directives and standards required for use in potentially explosive atmospheres are the sole responsibility of the application device manufacturer.

[Table 26](#) describes the maximum total internal capacitance and the maximum total internal inductance, considering internal parts tolerance, provided by TOBY-L2 series modules.

Module	Parameter	Description	Value	Unit
TOBY-L200, TOBY-L201	Ci	Maximum total internal capacitance	267	μF
	Li	Maximum total internal inductance	12.8	μH
TOBY-L210, TOBY-L220, TOBY-L280	Ci	Maximum total internal capacitance	267	μF
	Li	Maximum total internal inductance	12.9	μH

**Table 26: TOBY-L2 series maximum total internal capacitance and maximum total internal inductance**

[Table 27](#) describes the maximum RF output power transmitted by TOBY-L2 series modules from the primary antenna (**ANT1**) pin as Power Class 4 Mobile Stations for GSM 850 / E-GSM 900 bands and/or as Power Class 3 User Equipment for the LTE / UMTS bands.

Module	Parameter	Description	Value	Unit
TOBY-L200, TOBY-L210, TOBY-L280	ANT1 Pout	Maximum RF output power from ANT1 pin	35.0	dBm
TOBY-L201, TOBY-L220	ANT1 Pout	Maximum RF output power from ANT1 pin	25.0	dBm

**Table 27: TOBY-L2 series maximum RF output power**

 The TOBY-L2 series modules do not contain internal blocks which increase the input voltage (e.g. like step-up, duplicators, boosters, etc.) except for the primary antenna (**ANT1**) pin which maximum RF output power is illustrated in [Table 27](#).

## 5 Mechanical specifications

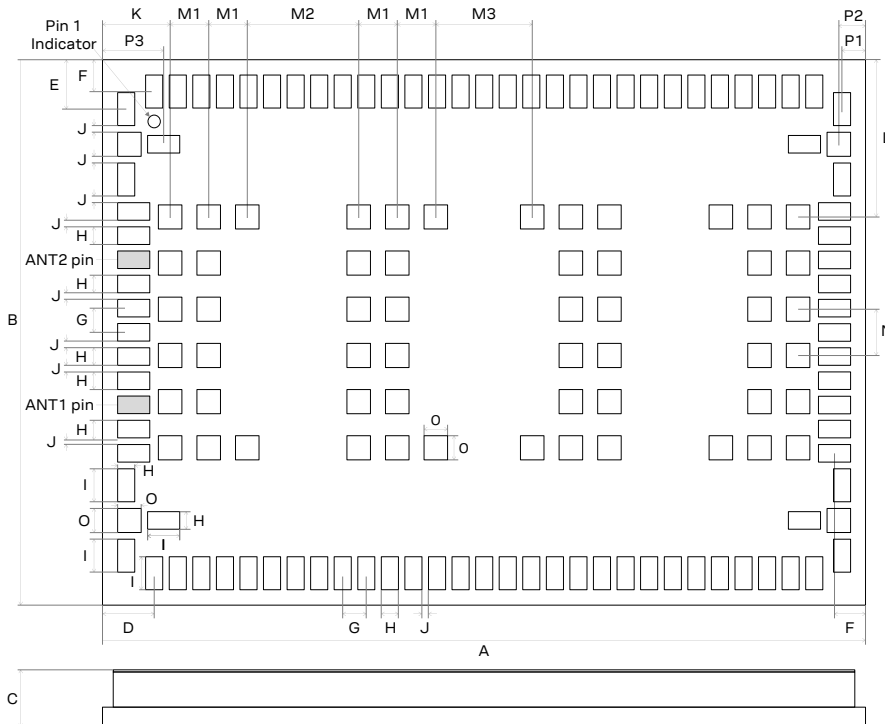

Figure 3: TOBY-L2 series dimensions (bottom and side views)

Parameter	Description	Typical	Tolerance
A	Module height [mm]	35.6 (1401.6 mil)	+0.20/-0.20 (+7.9/-7.9 mil)
B	Module width [mm]	24.8 (976.4 mil)	+0.20/-0.20 (+7.9/-7.9 mil)
C	Module thickness [mm]	2.6 (102.4 mil)	+0.27/-0.17 (+10.6/-6.7 mil)
D	Horizontal edge to lateral pin pitch [mm]	2.4 (94.5 mil)	+0.20/-0.20 (+7.9/-7.9 mil)
E	Vertical edge to lateral pin pitch [mm]	2.25 (88.6 mil)	+0.20/-0.20 (+7.9/-7.9 mil)
F	Edge to lateral pin pitch [mm]	1.45 (57.1 mil)	+0.20/-0.20 (+7.9/-7.9 mil)
G	Lateral pin to pin pitch [mm]	1.1 (43.3 mil)	+0.05/-0.05 (+2.0/-2.0 mil)
H	Lateral pin height [mm]	0.8 (31.5 mil)	+0.05/-0.05 (+2.0/-2.0 mil)
I	Lateral pin width [mm]	1.5 (59.1 mil)	+0.05/-0.05 (+2.0/-2.0 mil)
J	Lateral pin to pin distance [mm]	0.3 (11.8 mil)	+0.05/-0.05 (+2.0/-2.0 mil)
K	Horizontal edge to central pin pitch [mm]	3.15 (124.0 mil)	+0.20/-0.20 (+7.9/-7.9 mil)
L	Vertical edge to central pin pitch [mm]	7.15 (281.5 mil)	+0.20/-0.20 (+7.9/-7.9 mil)
M1	Central pin to pin horizontal pitch [mm]	1.8 (70.9 mil)	+0.05/-0.05 (+2.0/-2.0 mil)
M2	Central pin to pin horizontal pitch [mm]	5.2 (204.7 mil)	+0.05/-0.05 (+2.0/-2.0 mil)
M3	Central pin to pin horizontal pitch [mm]	4.5 (177.2 mil)	+0.05/-0.05 (+2.0/-2.0 mil)
N	Central pin to pin vertical pitch [mm]	2.1 (82.7 mil)	+0.05/-0.05 (+2.0/-2.0 mil)
O	Central pin height and width [mm]	1.1 (43.3 mil)	+0.05/-0.05 (+2.0/-2.0 mil)
P1	Horizontal edge to corner pin pitch [mm]	1.1 (43.3 mil)	+0.20/-0.20 (+7.9/-7.9 mil)
P2	Horizontal edge to corner pin pitch [mm]	1.25 (49.2 mil)	+0.20/-0.20 (+7.9/-7.9 mil)
P3	Horizontal edge to corner pin pitch [mm]	2.85 (112.2 mil)	+0.20/-0.20 (+7.9/-7.9 mil)
Weight	Module weight [g]	4.8	

Table 28: TOBY-L2 series dimensions

- Module Height tolerance +/-0.20 mm may be exceeded close to the corners of the PCB due to cutting process: in worst case the Height could be +0.40 mm longer than the typical value.
- For information regarding Footprint and Paste Mask recommended for the application board integrating the cellular module, see TOBY-L2 / MPC1-L2 series system integration manual [2].



## 6 Qualification and approvals

### 6.1 Reliability tests

Tests for product family qualifications according to ISO 16750 “Road vehicles - Environmental conditions and testing for electrical and electronic equipment”, and appropriate standards.

### 6.2 Approvals

TOBY-L2 series modules comply with the Directive 2011/65/EU of the European Parliament and the Council on the Restriction of Use of certain Hazardous Substances in Electrical and Electronic Equipment (EU RoHS 2) and its amendment Directive (EU) 2015/863 (EU RoHS 3).

TOBY-L2 series modules are RoHS 3 compliant.

No natural rubbers, hygroscopic materials, or materials containing asbestos are employed

Table 29 summarizes the main approvals for TOBY-L2 series modules.

Certification scheme	TOBY-L200	TOBY-L201	TOBY-L210	TOBY-L220	TOBY-L280
GCF conformance	•	•	•		•
PTCRB conformance	•	•	•		•
CE (European Conformity)	•		•		•
FCC (US Certification)	•	•	•		•
FCC identification number	XPYTOBYL200	XPYTOBYL201	XPYTOBYL210		XPYTOBYL280
ISED (Canadian Certification)	•	•	•		•
ISED certification number	8595A-TOBYL200	8595A-TOBYL201	8595A-TOBYL210		8595A-TOBYL280
ANATEL (Brazilian Certification)	•				•
RCM (Australian Certification)			•		•
NCC (Taiwanese Certification)			•		•
KC (Korean Certification)			•		
GITEKI (Japanese Certification)			•	•	
NTT DoCoMo (Network Operator)				•	
SoftBank (Network Operator)			•		
AT&T (Network Operator)	•	•			
Verizon (Network Operator)		•			
Rogers (Network Operator)	•				
Telus (Network Operator)		•			
Deutsche Telekom (Network Operator)			•		

Table 29: TOBY-L2 series main certification approvals summary

 The above listed certifications might not be available for all the different product type numbers. Please contact the u-blox office or sales representative nearest you for the complete list of certification approvals available for the selected product ordering number.

## 7 Product handling & soldering

### 7.1 Packaging

TOBY-L2 series modules are delivered as hermetically sealed, reeled tapes to enable efficient production, production lot set-up and tear-down. For more information about packaging, see the u-blox package information user guide [6].

#### 7.1.1 Reels

TOBY-L2 series modules are deliverable in quantities of 150 pieces on a reel. The modules are delivered using the reel Type B3 described in the Figure 4 and in the u-blox package information user guide [6].

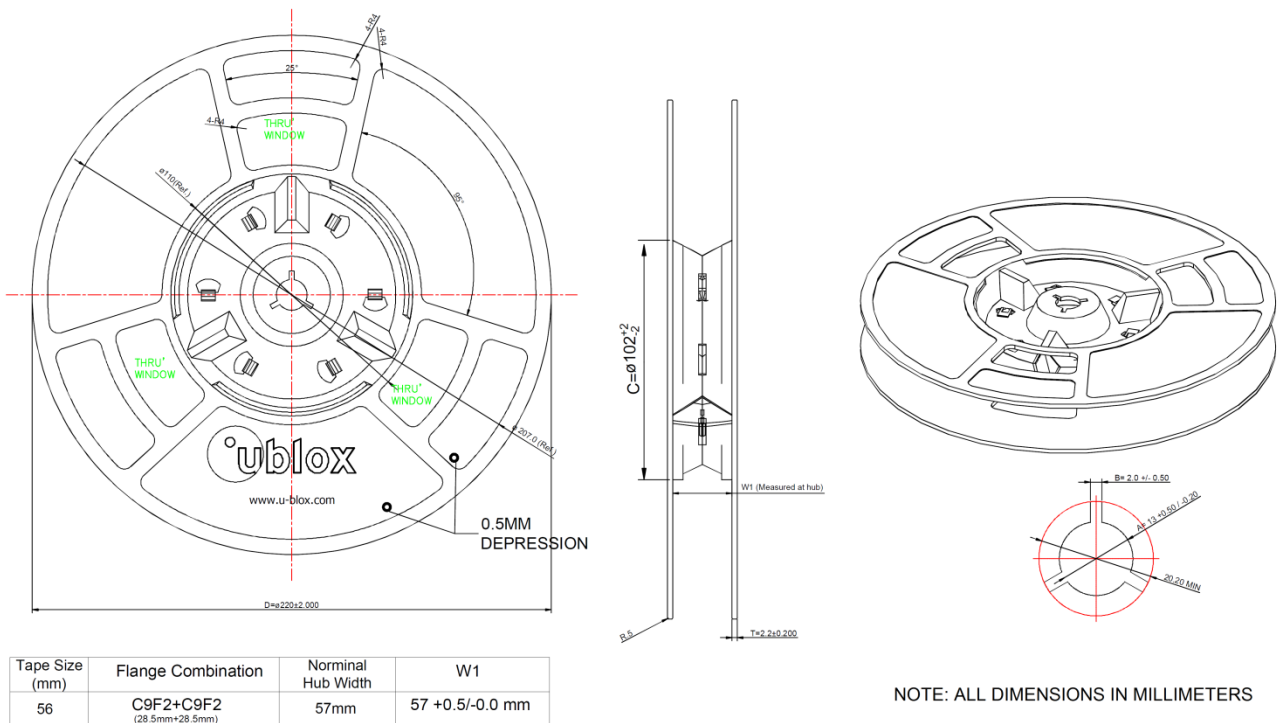

Figure 4: TOBY-L2 series modules reel

Parameter	Specification
Reel type	B3
Delivery quantity	150

Table 30: Reel information for TOBY-L2 series modules

Quantities of less than 150 pieces are also available. Contact u-blox for more information.

### 7.1.2 Tapes

Figure 5 shows the position and the orientation of TOBY-L2 modules as they are delivered on the tape, while Figure 6 specifies the tape dimensions.

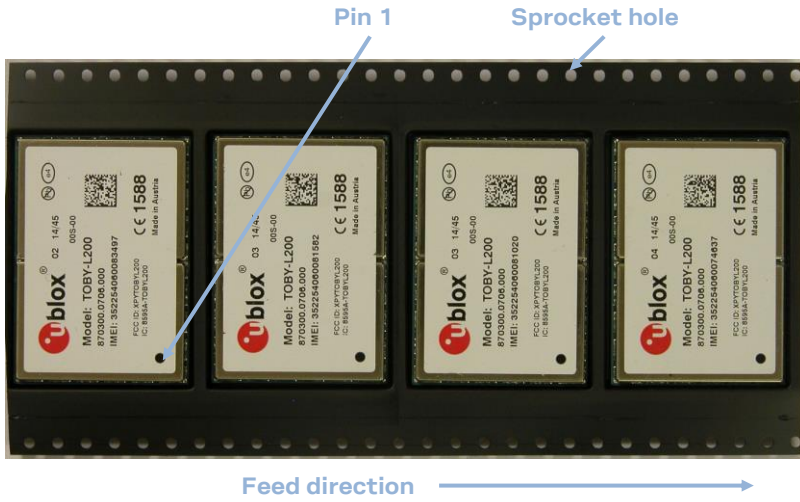

Figure 5: Orientation for TOBY-L2 modules on tape

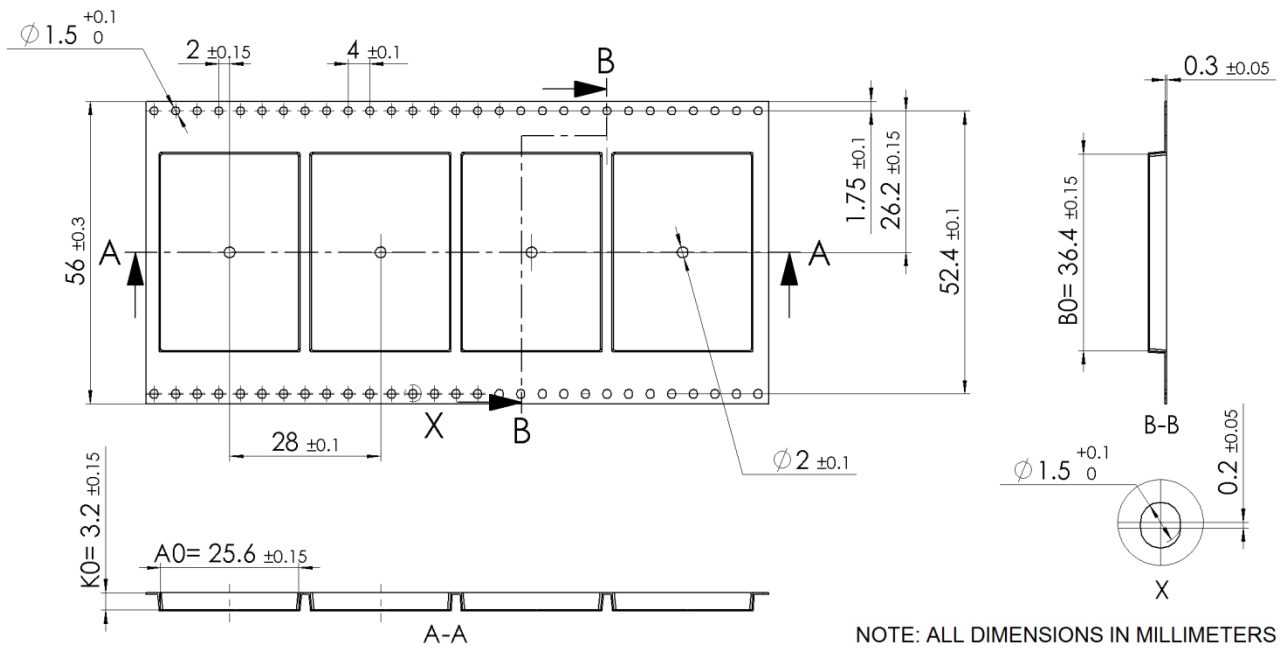



Figure 6: TOBY-L2 series modules tape

## 7.2 Moisture sensitivity levels

-  TOBY-L2 series modules are moisture sensitive devices (MSD) in accordance to the IPC/JEDEC specification.

The moisture sensitivity level (MSL) relates to the packaging and handling precautions required. TOBY-L2 series modules are rated at MSL level 4. For more information regarding moisture sensitivity levels, labeling, storage and drying, see the u-blox package information user guide [6].

-  For MSL standard see IPC/JEDEC J-STD-020 (can be downloaded from [www.jedec.org](http://www.jedec.org) ).

## 7.3 Reflow soldering

Reflow profiles are to be selected according to u-blox recommendations (see the TOBY-L2 / MPCI-L2 series system integration manual [2]).

-  Failure to observe these recommendations can result in severe damage to the device!

## 7.4 ESD precautions

-  TOBY-L2 series modules contain highly sensitive electronic circuitry and are Electrostatic Sensitive Devices (ESD). Handling TOBY-L2 series modules without proper ESD protection may destroy or damage them permanently.

TOBY-L2 series modules are Electrostatic Sensitive Devices (ESD) and require special ESD precautions typically applied to ESD sensitive components.

[Table 7](#) details the maximum ESD ratings of the TOBY-L2 series modules.

Proper ESD handling and packaging procedures must be applied throughout the processing, handling and operation of any application that incorporates a TOBY-L2 series module.

ESD precautions should be implemented on the application board where the module is mounted, as described in the TOBY-L2 / MPCI-L2 series system integration manual [2].

-  Failure to observe these recommendations can result in severe damage to the device!

## 8 Default settings

Item	AT settings	Comments
USB interface	Enabled	<p>TOBY-L2 series modules provide by default the following set of USB functions:</p> <ul style="list-style-type: none"> <li>• CDC-ACM for AT command and data</li> <li>• RNDIS for Ethernet-over-USB connection</li> </ul> <p>The USB can be configured by the AT+UUSBCONF command to select different sets of USB functions available in mutually exclusive way, configuring the active USB profile consisting of a specific set of functions with various capabilities and purposes (for more details, see the TOBY-L2 / MPCI-L2 series system integration manual <a href="#">[2]</a> and the u-blox AT commands manual <a href="#">[1]</a>, +UUSBCONF AT command).</p>
Power saving	AT+UPSV=0	Disabled
Network registration	AT+COPS=0	Self network registration

**Table 31: Default settings**

## 9 Labeling and ordering information

### 9.1 Product labeling

Figure 7 illustrates an example of TOBY-L2 series modules' label, including important product information: u-blox logo, production lot, Pb-free marking, product type number, IMEI number, certifications info, and production country.



Figure 7: Example of TOBY-L2 series module label

### 9.2 Explanation of codes

Three different product code formats are used. The **Product Name** is used in documentation such as this data sheet and identifies all the u-blox products, independent of packaging and quality grade. The **Ordering Code** includes options and quality, while the **Type Number** includes the hardware and firmware versions. Table 32 details these 3 different formats:

Format	Structure
Product Name	PPPP-TGVV
Ordering Code	PPPP-TGVV-MMQ
Type Number	PPPP-TGVV-MMQ-XX

Table 32: Product code formats

Table 33 explains the parts of the product code.

Code	Meaning	Example
PPPP	Form factor	TOBY
TG	Platform (Technology and Generation) <ul style="list-style-type: none"> <li>• Dominant technology: G: GSM; U: HSUPA; C: CDMA 1xRTT; N: NB-IoT; R: LTE low data rate (Cat 1 and below); L: LTE high data rate (Cat 3 and above)</li> <li>• Generation: 1...9</li> </ul>	L2
VV	Variant function set based on the same platform [00...99]	00
MM	Major product version [00...99]	00
Q	Product grade <ul style="list-style-type: none"> <li>• S = professional</li> <li>• A = automotive</li> </ul>	S
XX	Minor product version	Default value is 00

Table 33: Part identification code

## 9.3 Ordering information

Ordering No.	Product
TOBY-L200-00S	Module with LTE bands 2 / 4 / 5 / 7 / 17, 3G bands 1 / 2 / 4 / 5 / 8, 2G bands 850 / 900 / 1800 / 1900. Mainly designed for operation in America. 35.6 x 24.8 x 2.6 mm, 150 pcs/reel
TOBY-L200-02S	Module with LTE bands 2 / 4 / 5 / 7 / 17, 3G bands 1 / 2 / 4 / 5 / 8, 2G bands 850 / 900 / 1800 / 1900. Mainly designed for operation in America. It supports UART, SDIO, I2C, I2S, ANT_DET, GPIO and embedded TCP/UDP, HTTP/FTP, TLS/SSL. 35.6 x 24.8 x 2.6 mm, 150 pcs/reel
TOBY-L200-03S	Module with LTE bands 2 / 4 / 5 / 7 / 17, 3G bands 1 / 2 / 4 / 5 / 8, 2G bands 850 / 900 / 1800 / 1900. Mainly designed for operation in America. It supports UART, SDIO, I2C, I2S, ANT_DET, GPIO and embedded TCP/UDP, HTTP/FTP, TLS/SSL, SAP. 35.6 x 24.8 x 2.6 mm, 150 pcs/reel
TOBY-L201-01S	Module with LTE bands 2 / 4 / 5 / 13 / 17, 3G bands 2 / 5. Mainly designed for operation in America. It supports UART and embedded TCP/UDP, HTTP/FTP. 35.6 x 24.8 x 2.6 mm, 150 pcs/reel
TOBY-L201-02S	Module with LTE bands 2 / 4 / 5 / 13 / 17, 3G bands 2 / 5. Mainly designed for operation in America. It supports UART, SDIO, ANT_DET, GPIO and embedded TCP/UDP, HTTP/FTP. 35.6 x 24.8 x 2.6 mm, 150 pcs/reel
TOBY-L210-00S	Module with LTE bands 1 / 3 / 5 / 7 / 8 / 20, 3G bands 1 / 2 / 5 / 8, 2G bands 850 / 900 / 1800 / 1900. Mainly designed for operation in Europe, Asia and other countries. 35.6 x 24.8 x 2.6 mm, 150 pcs/reel
TOBY-L210-60S	Module with LTE bands 1 / 3 / 5 / 7 / 8 / 20, 3G bands 1 / 2 / 5 / 8, 2G bands 850 / 900 / 1800 / 1900. Approved by SoftBank Japanese mobile network operator. It supports UART interface. 35.6 x 24.8 x 2.6 mm, 150 pcs/reel
TOBY-L210-62S	Module with LTE bands 1 / 3 / 5 / 7 / 8 / 20, 3G bands 1 / 2 / 5 / 8, 2G bands 850 / 900 / 1800 / 1900. Approved by SoftBank Japanese mobile network operator. It supports UART, SDIO, I2C, I2S, ANT_DET, GPIO, embedded TCP/UDP, HTTP/FTP, TLS/SSL. 35.6 x 24.8 x 2.6 mm, 150 pcs/reel
TOBY-L210-65S	Module with LTE bands 1 / 3 / 5 / 7 / 8, 3G bands 1 / 2 / 5 / 8, 2G bands 850 / 900 / 1800 / 1900. Approved by SoftBank Japanese mobile network operator. It supports UART, SDIO, I2C, I2S, ANT_DET, GPIO, embedded TCP/UDP, HTTP/FTP, TLS/SSL. 35.6 x 24.8 x 2.6 mm, 150 pcs/reel
TOBY-L210-02S	Module with LTE bands 1 / 3 / 5 / 7 / 8 / 20, 3G bands 1 / 2 / 5 / 8, 2G bands 850 / 900 / 1800 / 1900. Mainly designed for operation in Europe, Asia and other countries. It supports UART, SDIO, I2C, I2S, ANT_DET, GPIO and embedded TCP/UDP, HTTP/FTP, TLS/SSL. 35.6 x 24.8 x 2.6 mm, 150 pcs/reel
TOBY-L210-03S	Module with LTE bands 1 / 3 / 5 / 7 / 8 / 20, 3G bands 1 / 2 / 5 / 8, 2G bands 850 / 900 / 1800 / 1900. Mainly designed for operation in Europe, Asia and other countries. It supports UART, SDIO, I2C, I2S, ANT_DET, GPIO and embedded TCP/UDP, HTTP/FTP, TLS/SSL, SAP. 35.6 x 24.8 x 2.6 mm, 150 pcs/reel
TOBY-L220-02S	Module with LTE bands 1 / 3 / 5 / 6 / 8 / 19, 3G bands 1 / 6 / 8 / 19. Mainly designed for operation in Japan. It supports UART, SDIO, I2C, I2S, ANT_DET, GPIO and embedded TCP/UDP, HTTP/FTP, TLS/SSL. 35.6 x 24.8 x 2.6 mm, 150 pcs/reel
TOBY-L220-62S	Module with LTE bands 1 / 3 / 5 / 6 / 8 / 19. Approved by NTT DoCoMo Japanese mobile network operator. It supports UART, SDIO, I2C, I2S, ANT_DET, GPIO and embedded TCP/UDP, HTTP/FTP, TLS/SSL. 35.6 x 24.8 x 2.6 mm, 150 pcs/reel
TOBY-L280-02S	Module with LTE bands 1 / 3 / 5 / 7 / 8 / 28, 3G bands 1 / 2 / 5 / 8, 2G bands 850 / 900 / 1800 / 1900. Mainly designed for operation in South East-Asia and Oceania. It supports UART, SDIO, I2C, I2S, ANT_DET, GPIO and embedded TCP/UDP, HTTP/FTP, TLS/SSL. 35.6 x 24.8 x 2.6 mm, 150 pcs/reel
TOBY-L280-03S	Module with LTE bands 1 / 3 / 5 / 7 / 8 / 28, 3G bands 1 / 2 / 5 / 8, 2G bands 850 / 900 / 1800 / 1900. Mainly designed for operation in South East-Asia and Oceania. It supports UART, SDIO, I2C, I2S, ANT_DET, GPIO and embedded TCP/UDP, HTTP/FTP, TLS/SSL, SAP. 35.6 x 24.8 x 2.6 mm, 150 pcs/reel

**Table 34: Product ordering codes**

# Appendix

## A Glossary

Abbreviation	Definition
AC	Alternating Current
ACM	Application Communication Module* / Abstract Control Model*
ADC	Analog to Digital Converter
ANATEL	Agência Nacional de Telecomunicações (Brazilian National Telecommunications Agency)
AP	Application Processor
APN	Access Point Name
AT	Hayes ATtention Command Set
ATEX	EU Explosive Atmosphere Directive
BER	Bit Error Rate
BIP	Bearer Independent Protocol
CBS	Cell Broadcast Services
CDC	Communication Device Class
CDMA	Code-Division Multiple Access
CE	Certification Mark for compliance in the European Union
CLK	Clock
CMOS	Complementary Metal-Oxide-Semiconductor
CSFB	Circuit-Switched Fall-Back
CTS	Clear To Send
DC	Direct Current
DCD	Data Carrier Detect
DCE	Data Communication Equipment
DCS	Digital Cellular System
DDC	Display Data Channel
DL	Down Link (Reception)
DSR	Data Set Ready
DTE	Data Terminal Equipment
DTMF	Dual Tone Multi Frequency
DTR	Data Terminal Ready
EDGE	Enhanced Data rates for GSM Evolution
EGPRS	Enhanced General Packet Radio Service
ERS	External Reset Input Signal
ESD	Electrostatic Discharge
EU	European Union
FCC	Federal Communications Commission
FDD	Frequency Division Duplex
FOAT	Firmware (update) Over AT commands
FOTA	Firmware (update) Over-The-Air
FTP	File Transfer Protocol
FW	Firmware
GCF	Global Certification Forum
GDI	Generic Digital Interface
GERA	GSM EGPRS Radio Access
GITEKI	Gijutsu kijun tekigō shōmei - Japan technical standard conformity certification
GMSK	Gaussian Minimum-Shift Keying modulation
GND	Ground
GPIO	General Purpose Input/Output



Abbreviation	Definition
GPRS	General Packet Radio Services
GSM	Global System for Mobile communications
HDLC	High-level Data Link Control
HSDPA	High Speed Downlink Packet Access
HSPA	High Speed Packet Access
HSUPA	High Speed Uplink Packet Access
HTTP	HyperText Transfer Protocol
I/O	Input/Output
I2C	Inter-Integrated Circuit
I2S	Inter-IC Sound
IEC	International Electrotechnical Commission
IMEI	International Mobile Equipment Identity
IMS	IP Multimedia System
IP	Internet Protocol
ISED	Innovation, Science and Economic Development, formerly known as Industry Canada (IC)
ISO	International Organization for Standardization
ITU	International Telecommunications Union
LGA	Land Grid Array
LTE	Long-Term Evolution
M2M	Machine to Machine
ME	Mobile Equipment
MIMO	Multiple In Multiple Out
MSD	Moisture Sensitive Device
MSL	Moisture Sensitivity Level
MUX	Multiplexer
N/A	Not Applicable
NCC	National Communications Commission
PCB	Printed Circuit Board
PCM	Pulse Code Modulation
PCN	Product Change Notification
PMU	Power Management Unit
PPS	Protocol and Parameter Selection
PTCRB	PCS Type Certification Review Board
PU/PD	Pull-Up/Pull-Down
QPSK	Quadrature Phase Shift Keying
RAM	Random Access Memory
RCM	Regulatory Compliance Mark
RF	Radio Frequency
RI	Ring Indicator
RIL	Radio Interface Layer
RMC	Reference Measurement Channel
RNDIS	Remote Network Driver Interface Specification
RTC	Real Time Counter / Real Time Clock
RTS	Request To Send
RX	Receive Signal
SAP	SIM Access Profile
SCL	Serial Clock
SDA	Serial Data
SDIO	Secure Digital Input Output
SIM	Subscriber Identity Module
SMS	Short Message Service

Abbreviation	Definition
SSL	Secure Sockets Layer
TCP	Transmission Control Protocol
TCP/IP	Transmission Control Protocol/Internet Protocol
TDMA	Time-Division Multiple Access
TLS	Transport Layer Security
TS	Technical Specification
TX	Transmit Signal
TXD	Transmit Data
UART	Universal Asynchronous Receiver/Transmitter
UDP	User Datagram Protocol
UE	User Equipment
UL	Uplink (Transmission)
UMTS	Universal Mobile Telecommunications System
URC	Unsolicited Result Code
USB	Universal Serial Bus
VCC	Voltage Common Collector
VSWR	Voltage Standing Wave Ratio
WA	Word Alignment
WWAN	Wireless Wide Area Network (GSM / UMTS / LTE cellular radio technology)

**Table 35: Explanation of the abbreviations and terms used**

## Related documentation

- [1] u-blox AT commands manual, [UBX-13002752](#)
- [2] u-blox TOBY-L2 / MPC1-L2 series system integration manual, [UBX-13004618](#)
- [3] u-blox Android RIL source code application note, [UBX-13002041](#)
- [4] u-blox MUX implementation application note, [UBX-13001887](#)
- [5] u-blox Wi-Fi / cellular integration application note, [UBX-14003264](#)
- [6] u-blox package information user guide, [UBX-14001652](#)
- [7] 3GPP TS 27.007 - AT command set for User Equipment (UE)
- [8] 3GPP TS 27.005 - Use of Data Terminal Equipment - Data Circuit terminating Equipment (DTE - DCE) interface for Short Message Service (SMS) and Cell Broadcast Service (CBS)
- [9] 3GPP TS 27.010 - Terminal Equipment to User Equipment (TE-UE) multiplexer protocol
- [10] 3GPP TS 36.521-1 - Evolved Universal Terrestrial Radio Access; User Equipment conformance specification; Radio transmission and reception; Part 1: Conformance Testing
- [11] 3GPP TS 34.121-1 - User Equipment conformance specification; Radio transmission and reception (FDD); Part 1: Conformance specification
- [12] 3GPP TS 51.010-1 - Mobile Station conformance specification; Part 1: Conformance specification
- [13] ITU-T Recommendation V24, 02-2000. List of definitions for interchange circuits between Data Terminal Equipment (DTE) and Data Connection Equipment (DCE)
- [14] Universal Serial Bus Revision 2.0 specification, <https://www.usb.org/>
- [15] u-blox Windows Embedded OS USB driver installation application note, [UBX-14003263](#)
- [16] I2C-bus specification and user manual - UM10204 - NXP Semiconductors, <https://www.nxp.com/docs/en/user-guide/UM10204.pdf>
- [17] IEC 60079-0 - Explosive atmospheres, part 0: equipment general requirements
- [18] IEC 60079-11 - Explosive atmospheres, part 11: equipment protection by intrinsic safety 'i'
- [19] IEC 60079-26 - Explosive atmospheres, part 26: Equipment with EPL Ga
- [20] GSMA TS.34 - IoT device connection efficiency guidelines

 For regular updates to u-blox documentation and to receive product change notifications, register on our homepage ([www.u-blox.com](http://www.u-blox.com)).

## Revision history

Revision	Date	Name	Status / Comments
R01	02-Dec-2013	jpod / sses	Initial release
R02	23-Jul-2014	sses	Advance Information document status. Updated module pin 4 definition: VUSB_DET instead of RSVD; Updated UART, GPIOs and SIM detection support; Updated receiver sensitivity performance; Updated VCC current consumption; Updated PWR_ON and RESET_N timings characteristics
R03	30-Sep-2014	sses	Added and updated minor electrical characteristics
R04	28-Nov-2014	sses	Early Production Information document status Updated VUSB_DET description: the VUSB_DET functionality is not supported, and the pin should be left unconnected or it should not be driven high Added and updated minor electrical characteristics
R05	30-Jan-2015	sses	Added description of TOBY-L2xx-50S modules – the “50” product version. Updated UART, SDIO, GPIO sections and added consumption figures with USB not connected.
R06	04-Mar-2015	sfal	Extended the document applicability to TOBY-L201-01S and TOBY-L280-00S
R07	29-May-2015	sses	Document status reverted to Advance Information Corrected UART supported functionalities description. Added current consumption figures with module in low-power idle mode.

Revision	Date	Name	Status / Comments
R08	31-Jul-2015	sses	Document status reverted to Objective Specification. Added description of TOBY-L200-02S and TOBY-L210-02S product versions.
R09	19-Aug-2015	sses	Early Production Information document status. Added description of TOBY-L210-60S product version.
R10	25-Sep-2015	lpah	Document status reverted to Advance Information
R11	14-Oct-2015	sses	Document status reverted to Objective Specification. Added description of TOBY-L220-02S and TOBY-L280-02S product versions. Removed description of TOBY-L2xx-50S and TOBY-L280-00S product versions.
R12	26-Nov-2015	lpah	Document status changed to Early Production Information.
R13	03-Mar-2016	sses	Document status reverted to Advance Information. Added description of TOBY-L210-62S product version.
R14	31-Mar-2016	sses	Updated features planned for future product versions. Minor other corrections and description improvements.
R15	27-Apr-2016	lpah	Document status changed to Production Information
R16	15-Jul-2016	sses	Document status reverted to Objective Specification. Added description of TOBY-L201-02S product version.
R17	28-Sep-2016	sses	Document status updated to Advance Information. Updated support of some minor features in specific product versions.
R18	21-Oct-2016	lpah / sses	Document status updated to Early Production Information. Extended applicability to TOBY-L280-72S. Minor other corrections and description improvements.
R19	25-Nov-2016	lpah / sses	Extended applicability to TOBY-L200-00S-01. Removed applicability to TOBY-L280-72S.
R20	21-Dec-2016	lpah / sses	"Disclosure restriction" replaces "Document status" on page 2 and document footer. Extended document applicability to TOBY-L200-02S-01, TOBY-L210-02S-01 and TOBY-L280-02S-01. Updated support of some features in specific product versions.
R21	19-Apr-2017	lpah / sses	Extended document applicability to TOBY-L220-62S. Updated app version of TOBY-L200-02S-01, TOBY-L210-02S-01, and TOBY-L280-02S-01.
R22	05-Jun-2017	lpah / sses	Updated TOBY-L201-02S product status to Initial production status.
R23	23-Jun-2017	lpah / sses	Extended document applicability to TOBY-L200-03S, TOBY-L210-03S and TOBY-L280-03S
R24	27-Jul-2017	lpah	TOBY-L200-00S-01, TOBY-L210-00S-00, TOBY-L210-60S-01 product status to End of Life
R25	22-Dec-2017	lpah / sses	TOBY-L200-02S-01, TOBY-L210-02S-01, TOBY-L280-02S-01 product status to End of Life. Updated absolute maximum rating of VCC, V_BCKP, RESET_N, PWR_ON pins
R26	14-Feb-2019	lpah / sses	Extended document applicability to TOBY-L200-03S-01, TOBY-L201-02S-01, TOBY-L210-03S-01, TOBY-L280-03S-01. Updated TOBY-L201-01S, TOBY-L210-62S, TOBY-L220-02S, TOBY-L220-62S product status. Updated approvals info. Minor other corrections and description improvements.
R27	12-Apr-2019	lpah / sses	Updated TOBY-L200-03S-01, TOBY-L201-02S-01, TOBY-L210-03S-01, TOBY-L280-03S-01 product status Revised approvals section and RoHS statement. Minor other corrections and description improvements.
R28	31-Oct-2019	lpah	Updated TOBY-L210-62S product status Extended document applicability to TOBY-L210-65S product
R29	19-Feb-2020	lpah / sses	Extended document applicability to TOBY-L210-03S-34 type number Minor other corrections and description improvements.
R30	06-Apr-2020	lpah / sses	Updated TOBY-L210-65S product status
R31	09-Dec-2020	lpah / sses	Extended document applicability to TOBY-L201-02S-02 type number. Minor correction of some pads' dimensions (no impact for customers).
R32	27-May-2021	sses	Extended document applicability to TOBY-L200-03S-02, TOBY-L210-03S-02, TOBY-L210-65S-01, TOBY-L220-02S-01, TOBY-L220-62S-01, TOBY-L280-03S-02 Minor other corrections.
R33	30-Sep-2021	alos	Extended document applicability to TOBY-L200-03S-03, TOBY-L201-02S-03, TOBY-L210-03S-03, TOBY-L280-03S-03. Minor other clarifications.

# Contact

For complete contact information, visit us at [www.u-blox.com](http://www.u-blox.com).

## u-blox Offices

### North, Central and South America

#### u-blox America, Inc.

Phone: +1 703 483 3180  
Email: [info\\_us@u-blox.com](mailto:info_us@u-blox.com)

#### Regional Office West Coast:

Phone: +1 408 573 3640  
Email: [info\\_us@u-blox.com](mailto:info_us@u-blox.com)

#### Technical Support:

Phone: +1 703 483 3185  
Email: [support@u-blox.com](mailto:support@u-blox.com)

### Headquarters

#### Europe, Middle East, Africa

#### u-blox AG

Phone: +41 44 722 74 44  
Email: [info@u-blox.com](mailto:info@u-blox.com)  
Support: [support@u-blox.com](mailto:support@u-blox.com)

### Asia, Australia, Pacific

#### u-blox Singapore Pte. Ltd.

Phone: +65 6734 3811  
Email: [info\\_ap@u-blox.com](mailto:info_ap@u-blox.com)  
Support: [support\\_ap@u-blox.com](mailto:support_ap@u-blox.com)

#### Regional Office Australia:

Phone: +61 3 9566 7255  
Email: [info\\_anz@u-blox.com](mailto:info_anz@u-blox.com)  
Support: [support\\_ap@u-blox.com](mailto:support_ap@u-blox.com)

#### Regional Office China (Beijing):

Phone: +86 10 68 133 545  
Email: [info\\_cn@u-blox.com](mailto:info_cn@u-blox.com)  
Support: [support\\_cn@u-blox.com](mailto:support_cn@u-blox.com)

#### Regional Office China (Chongqing):

Phone: +86 23 6815 1588  
Email: [info\\_cn@u-blox.com](mailto:info_cn@u-blox.com)  
Support: [support\\_cn@u-blox.com](mailto:support_cn@u-blox.com)

#### Regional Office China (Shanghai):

Phone: +86 21 6090 4832  
Email: [info\\_cn@u-blox.com](mailto:info_cn@u-blox.com)  
Support: [support\\_cn@u-blox.com](mailto:support_cn@u-blox.com)

#### Regional Office China (Shenzhen):

Phone: +86 755 8627 1083  
Email: [info\\_cn@u-blox.com](mailto:info_cn@u-blox.com)  
Support: [support\\_cn@u-blox.com](mailto:support_cn@u-blox.com)

#### Regional Office India:

Phone: +91 80 405 092 00  
Email: [info\\_in@u-blox.com](mailto:info_in@u-blox.com)  
Support: [support\\_in@u-blox.com](mailto:support_in@u-blox.com)

#### Regional Office Japan (Osaka):

Phone: +81 6 6941 3660  
Email: [info\\_jp@u-blox.com](mailto:info_jp@u-blox.com)  
Support: [support\\_jp@u-blox.com](mailto:support_jp@u-blox.com)

#### Regional Office Japan (Tokyo):

Phone: +81 3 5775 3850  
Email: [info\\_jp@u-blox.com](mailto:info_jp@u-blox.com)  
Support: [support\\_jp@u-blox.com](mailto:support_jp@u-blox.com)

#### Regional Office Korea:

Phone: +82 2 542 0861  
Email: [info\\_kr@u-blox.com](mailto:info_kr@u-blox.com)  
Support: [support\\_kr@u-blox.com](mailto:support_kr@u-blox.com)

#### Regional Office Taiwan:

Phone: +886 2 2657 1090  
Email: [info\\_tw@u-blox.com](mailto:info_tw@u-blox.com)  
Support: [support\\_tw@u-blox.com](mailto:support_tw@u-blox.com)