

2-line IPAD™, EMI filter and ESD protection for speaker

Datasheet - production data

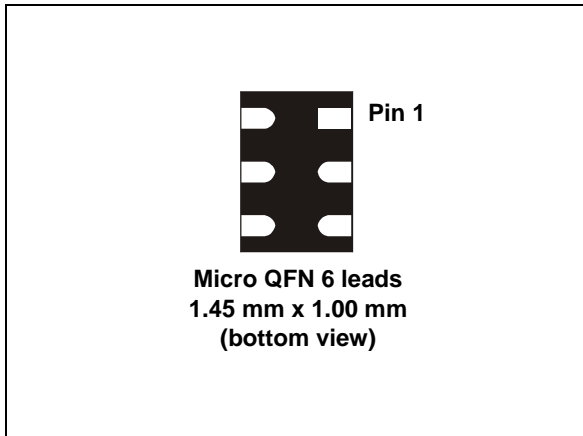
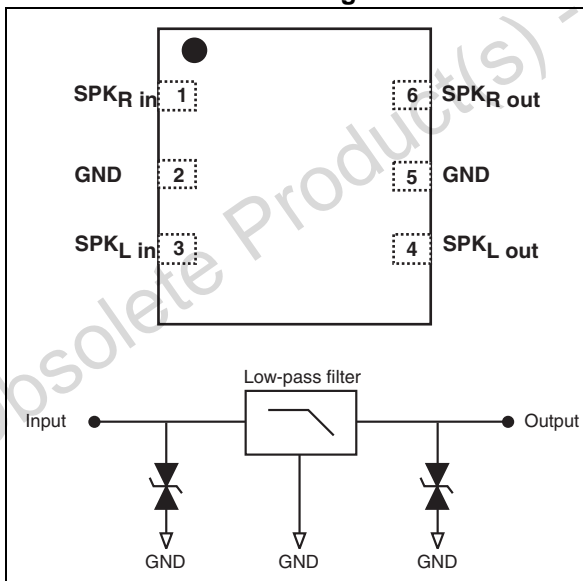

Figure 1. Pin configuration (top view) and basic cell configuration



Features

- EMI symmetrical (I/O) low-pass filter
- High efficiency in EMI filtering
- Very low PCB space consumption: 1.0 mm x 1.45 mm
- Pitch 0.5 mm
- Very thin package: 0.6 mm max
- High efficiency in ESD suppression
- High reliability offered by monolithic integration
- High reduction of parasitic elements through integration and wafer level packaging
- Lead-free package

Complies with following standards

- IEC 61000-4-2 level 4, input pins
 - 15 kV (air discharge)
 - 8 kV (contact discharge)
- IEC 61000-4-2 level 1, output pins
 - 2 kV (air discharge)
 - 2 kV (contact discharge)
- MILSTD883 Class 3B

Application

- Mobile telephones

Description

The EMIF02-SPK01M6 is a 2-line, highly integrated device designed to suppress EMI/RFI noise in all systems exposed to electromagnetic interference. This filter includes ESD protection circuitry, which prevents damage to the application when subjected to ESD surges up to 15 kV.

TM: IPAD is a trademark of STMicroelectronics

1 Characteristics

Table 1. Absolute ratings (limiting values at $T_{amb} = 25\text{ }^\circ\text{C}$ unless otherwise specified)

Symbol	Parameter	Value	Unit
V_{PP}	ESD discharge IEC 61000-4-2 air discharge on input pins	15	kV
	Air discharge	8	
	Contact discharge	2	
	ESD discharge IEC 61000-4-2 contact discharge on output pins	2	
	Contact discharge	2	
	MILSTD883 Class 3B	8	
T_j	Junction temperature	125	$^\circ\text{C}$
T_{op}	Operating temperature range	-30 to +85	$^\circ\text{C}$
T_{stg}	Storage temperature range	-55 to +150	$^\circ\text{C}$

Figure 2. Electrical characteristics (definitions)

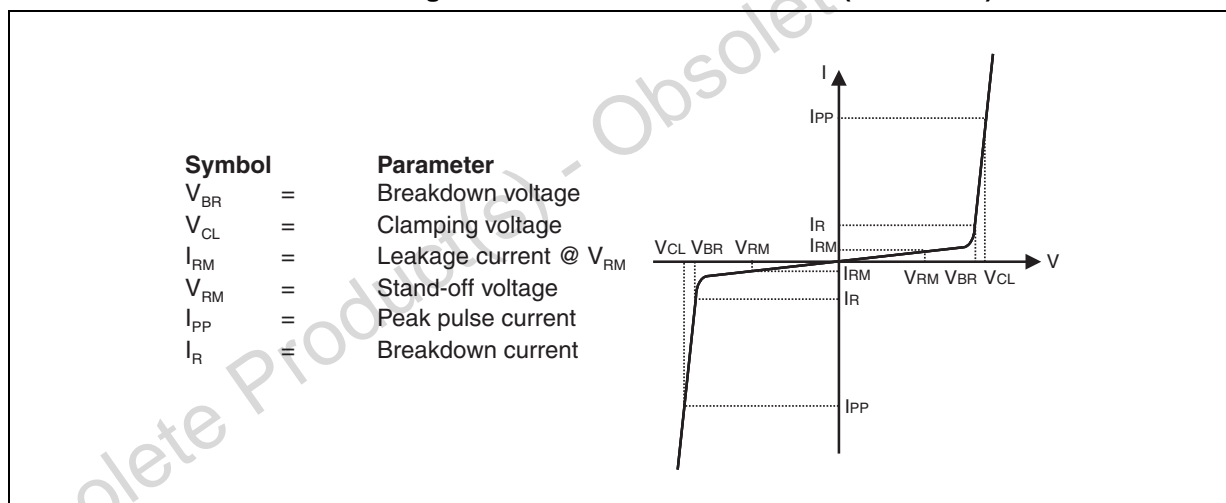

Table 2. Electrical characteristics ($T_{amb} = 25\text{ }^\circ\text{C}$)

Symbol	Test conditions	Min.	Typ.	Max.	Unit
V_{BR}	$I_R = 1\text{ mA}$	6	8		V
I_{RM}	$V_{RM} = 3\text{ V per line}$			500	nA
$R_{I/O}$	Tolerance $\pm 20\%$		10		Ω
C_{line}	$V_R = 0, F = 1\text{ MHz}, V_{OSC} = 30\text{ mV}, \pm 30\%$		220		pF

Figure 3. Attenuation measurement

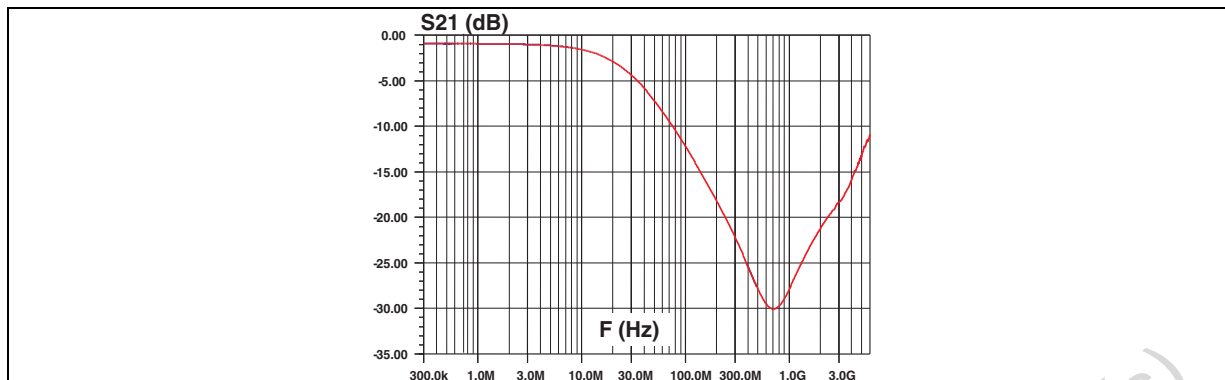

Figure 4. ESD response to IEC 61000-4-2 +15 kV air discharge on SPK R line

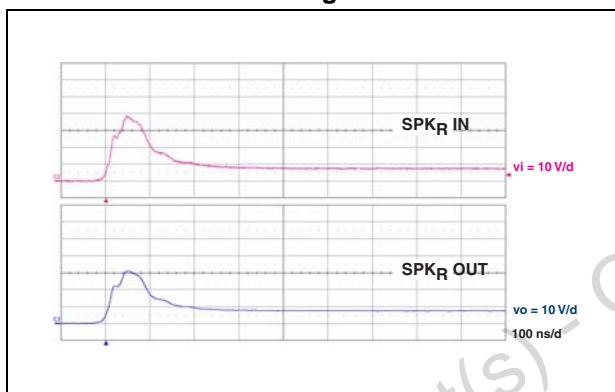

Figure 5. ESD response to IEC 61000-4-2 +15 kV air discharge on SPK L line

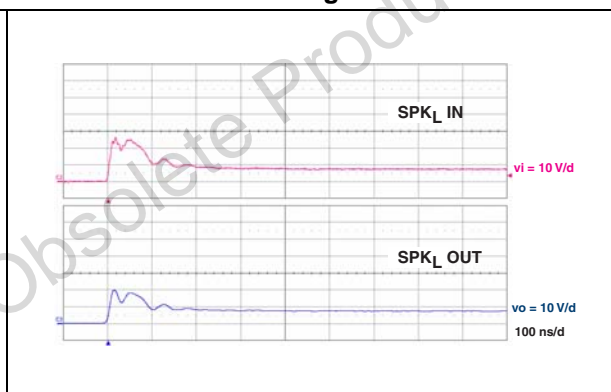

Figure 6. ESD response to IEC 61000-4-2 - 15 kV air discharge on SPK R line

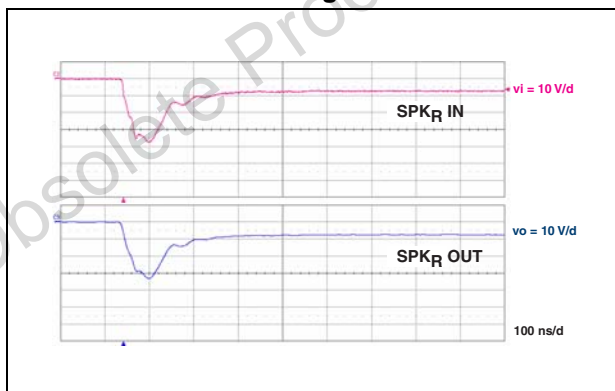
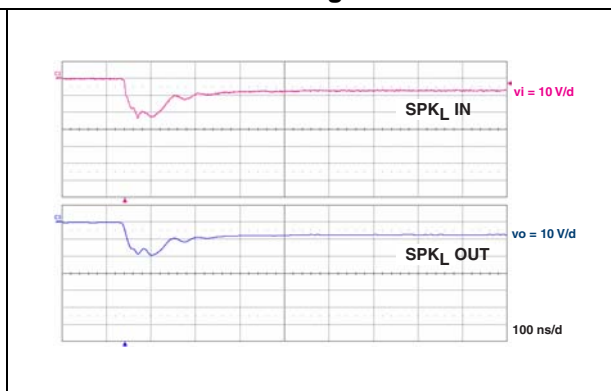
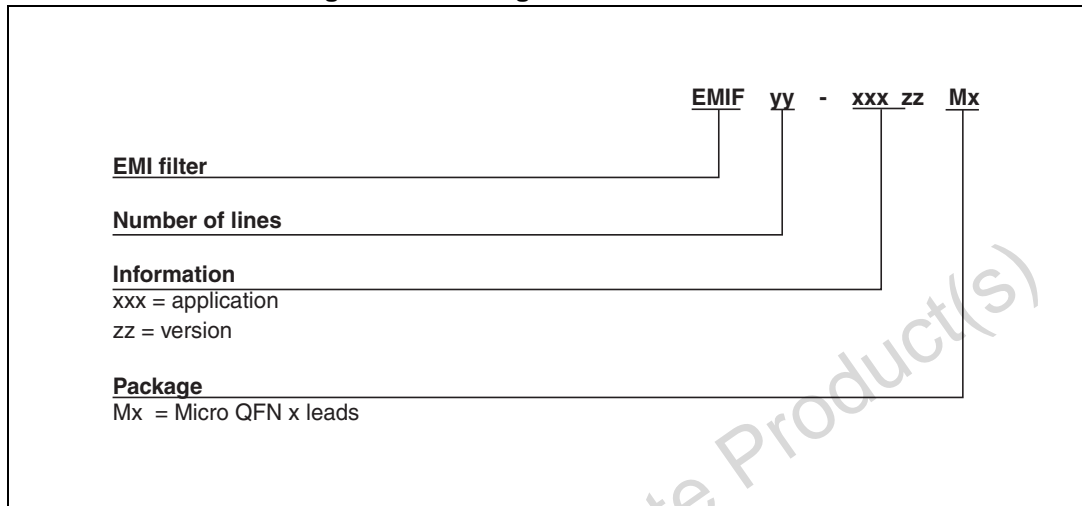

Figure 7. ESD response to IEC 61000-4-2 - 15 kV air discharge on SPK L line



2 Ordering information scheme

Figure 8. Ordering information scheme



3 Package information

- Epoxy meets UL94, V0
- Lead-free package

In order to meet environmental requirements, ST offers these devices in different grades of ECOPACK® packages, depending on their level of environmental compliance. ECOPACK® specifications, grade definitions and product status are available at: www.st.com. ECOPACK® is an ST trademark.

Table 3. Micro QFN 1.45 x 1.00 6L dimensions

Ref.	Dimensions					
	Millimeters			Inches		
	Min.	Typ.	Max.	Min.	Typ.	Max.
A	0.50	0.55	0.60	0.020	0.022	0.024
A1	0.00	0.02	0.05	0.000	0.001	0.002
b	0.18	0.25	0.30	0.007	0.010	0.012
D		1.45			0.057	
E		1.00			0.039	
e		0.50			0.020	
K	0.20			0.008		
L	0.30	0.35	0.40	0.012	0.014	0.016

Figure 9. Footprint in mm [inches]

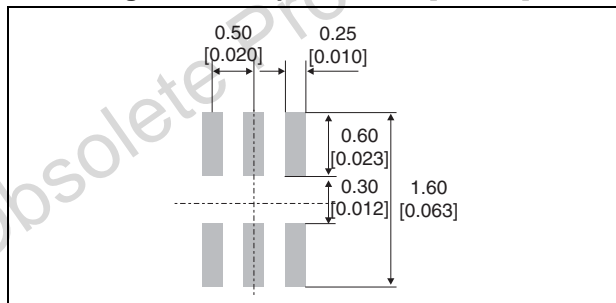

Figure 10. Marking

Dot: Pin 1 Identification
 K = Marking

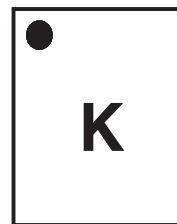
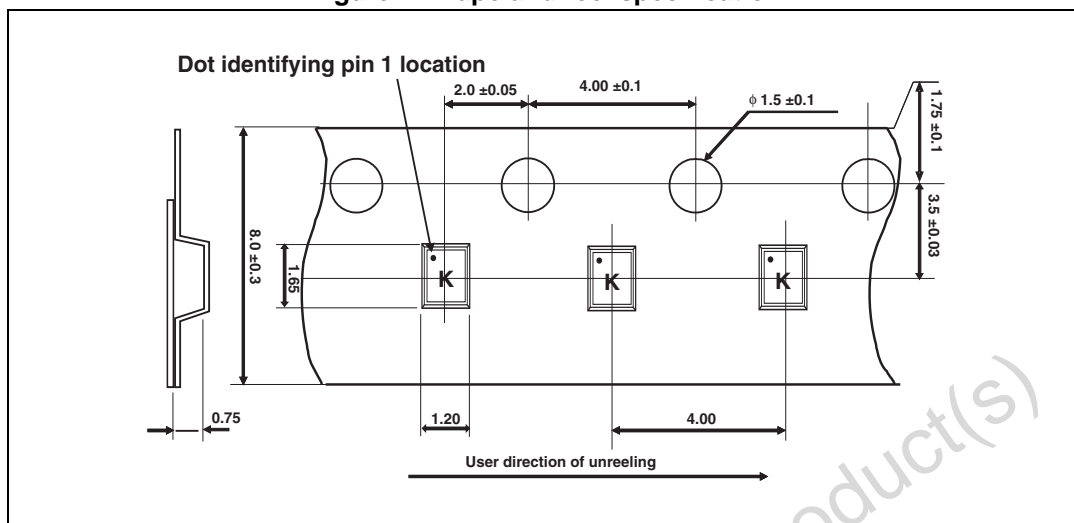

Figure 11. Tape and reel specification



Note: Product marking may be rotated by 90° for assembly plant differentiation. In no case should this product marking be used to orient the component for its placement on a PCB. Only pin 1 mark is to be used for this purpose.

Obsolete Product(s) - Obsolete Product(s)

4 Recommendation on PCB assembly

4.1 Stencil opening design

1. General recommendation on stencil opening design
 - a) Stencil Opening Dimensions: L (Length), W (Width), T (Thickness).

Figure 12. Stencil opening dimensions

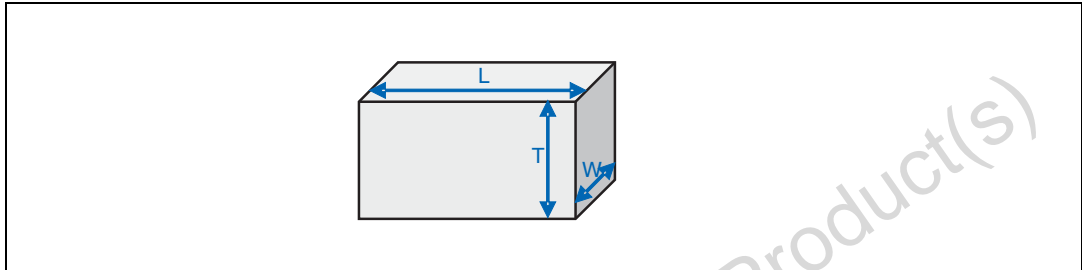

- b) General Design Rule
 - Stencil thickness (T) = 75 ~ 125 μm
 - Aspect Ratio = $\frac{W}{T} \geq 1.5$
 - Aspect Area = $\frac{L \times W}{2T(L + W)} \geq 0.66$

2. Reference design
 - a) Stencil opening thickness: 100 μm
 - b) Stencil opening for leads: Opening to footprint ratio is 90%.

Figure 13. Recommended stencil window position

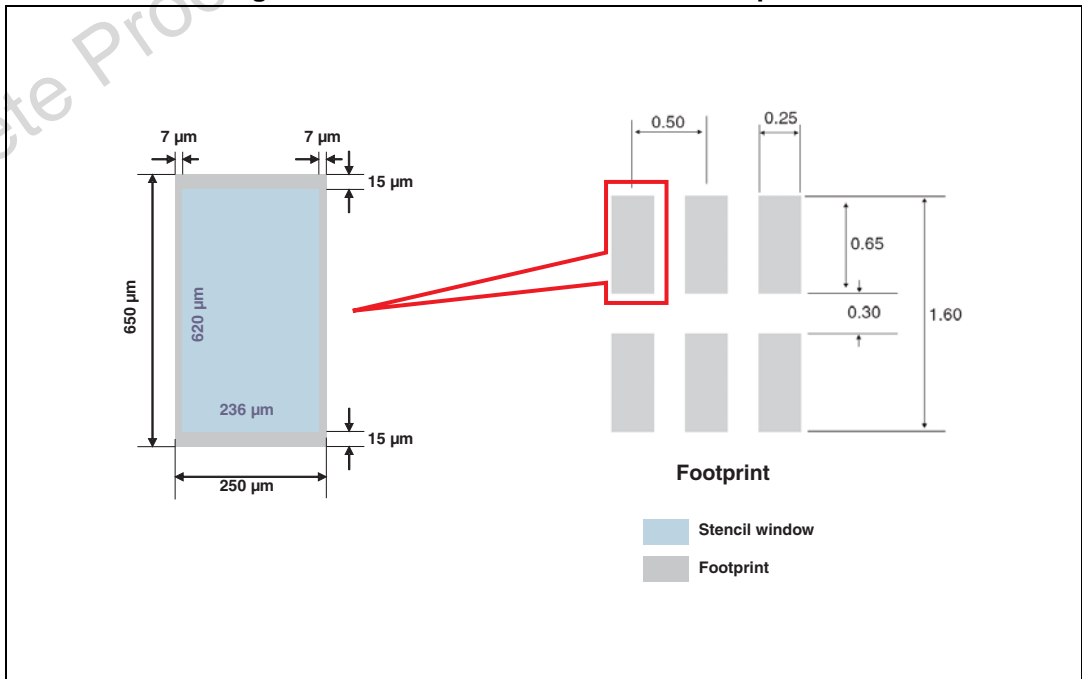

4.2 Solder paste

1. Halide-free flux qualification ROL0 according to ANSI/J-STD-004.
2. "No clean" solder paste is recommended.
3. Offers a high tack force to resist component movement during high speed
4. Solder paste with fine particles: powder particle size is 20-45 μm .

4.3 Placement

1. Manual positioning is not recommended.
2. It is recommended to use the lead recognition capabilities of the placement system, not the outline centering
3. Standard tolerance of ± 0.05 mm is recommended.
4. 3.5 N placement force is recommended. Too much placement force can lead to squeezed out solder paste and cause solder joints to short. Too low placement force can lead to insufficient contact between package and solder paste that could cause open solder joints or badly centered packages.
5. To improve the package placement accuracy, a bottom side optical control should be performed with a high resolution tool.
6. For assembly, a perfect supporting of the PCB (all the more on flexible PCB) is recommended during solder paste printing, pick and place and reflow soldering by using optimized tools.

4.4 PCB design preference

1. To control the solder paste amount, the closed via is recommended instead of open vias.
2. The position of tracks and open vias in the solder area should be well balanced. The symmetrical layout is recommended, in case any tilt phenomena caused by asymmetrical solder paste amount due to the solder flow away.

4.5 Reflow profile

Figure 14. ST ECOPACK recommended soldering reflow profile for PCB mounting

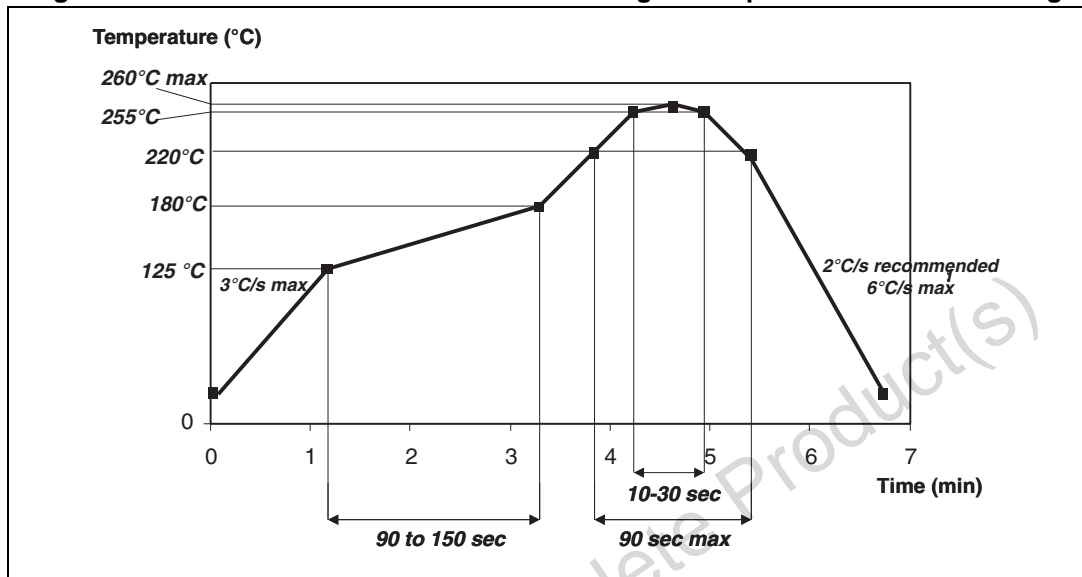

Note: Minimize air convection currents in the reflow oven to avoid component movement.

5 Ordering information

Table 4. Ordering information

Order code	Marking	Package	Weight	Base qty	Delivery mode
EMIF02-SPK01M6	K ⁽¹⁾	Micro QFN	2.2 mg	3000	Tape and reel (7")

1. The marking can be rotated by 90° to differentiate assembly location

6 Revision history

Table 5. Document revision history

Date	Revision	Changes
11-Sep-2009	1	Initial release
21-Sep-2009	2	Updated Figure 2 .
14-Mar-2014	3	Minor text changes

Please Read Carefully:

Information in this document is provided solely in connection with ST products. STMicroelectronics NV and its subsidiaries ("ST") reserve the right to make changes, corrections, modifications or improvements, to this document, and the products and services described herein at any time, without notice.

All ST products are sold pursuant to ST's terms and conditions of sale.

Purchasers are solely responsible for the choice, selection and use of the ST products and services described herein, and ST assumes no liability whatsoever relating to the choice, selection or use of the ST products and services described herein.

No license, express or implied, by estoppel or otherwise, to any intellectual property rights is granted under this document. If any part of this document refers to any third party products or services it shall not be deemed a license grant by ST for the use of such third party products or services, or any intellectual property contained therein or considered as a warranty covering the use in any manner whatsoever of such third party products or services or any intellectual property contained therein.

UNLESS OTHERWISE SET FORTH IN ST'S TERMS AND CONDITIONS OF SALE ST DISCLAIMS ANY EXPRESS OR IMPLIED WARRANTY WITH RESPECT TO THE USE AND/OR SALE OF ST PRODUCTS INCLUDING WITHOUT LIMITATION IMPLIED WARRANTIES OF MERCHANTABILITY, FITNESS FOR A PARTICULAR PURPOSE (AND THEIR EQUIVALENTS UNDER THE LAWS OF ANY JURISDICTION), OR INFRINGEMENT OF ANY PATENT, COPYRIGHT OR OTHER INTELLECTUAL PROPERTY RIGHT.

ST PRODUCTS ARE NOT DESIGNED OR AUTHORIZED FOR USE IN: (A) SAFETY CRITICAL APPLICATIONS SUCH AS LIFE SUPPORTING, ACTIVE IMPLANTED DEVICES OR SYSTEMS WITH PRODUCT FUNCTIONAL SAFETY REQUIREMENTS; (B) AERONAUTIC APPLICATIONS; (C) AUTOMOTIVE APPLICATIONS OR ENVIRONMENTS, AND/OR (D) AEROSPACE APPLICATIONS OR ENVIRONMENTS. WHERE ST PRODUCTS ARE NOT DESIGNED FOR SUCH USE, THE PURCHASER SHALL USE PRODUCTS AT PURCHASER'S SOLE RISK, EVEN IF ST HAS BEEN INFORMED IN WRITING OF SUCH USAGE, UNLESS A PRODUCT IS EXPRESSLY DESIGNATED BY ST AS BEING INTENDED FOR "AUTOMOTIVE, AUTOMOTIVE SAFETY OR MEDICAL" INDUSTRY DOMAINS ACCORDING TO ST PRODUCT DESIGN SPECIFICATIONS. PRODUCTS FORMALLY ESCC, QML OR JAN QUALIFIED ARE DEEMED SUITABLE FOR USE IN AEROSPACE BY THE CORRESPONDING GOVERNMENTAL AGENCY.

Resale of ST products with provisions different from the statements and/or technical features set forth in this document shall immediately void any warranty granted by ST for the ST product or service described herein and shall not create or extend in any manner whatsoever, any liability of ST.

ST and the ST logo are trademarks or registered trademarks of ST in various countries.

Information in this document supersedes and replaces all information previously supplied.

The ST logo is a registered trademark of STMicroelectronics. All other names are the property of their respective owners.

© 2014 STMicroelectronics - All rights reserved

STMicroelectronics group of companies

Australia - Belgium - Brazil - Canada - China - Czech Republic - Finland - France - Germany - Hong Kong - India - Israel - Italy - Japan - Malaysia - Malta - Morocco - Philippines - Singapore - Spain - Sweden - Switzerland - United Kingdom - United States of America

www.st.com

