

3000W FAN COOLED

AC-DC POWER SUPPLIES

The HDS3000 series offers users both output voltage and output current programming (0-105%) via resistance, voltage or I²C bus in a very high efficiency, high power density 3kW chassis mount package. Measuring just 5.0" x 5.0" x 14.41", the HDS3000 also features active current sharing, remote on/off, remote sense and a power OK signal. The standby output is available whenever the mains supply is present and can be user selected as either 5V at 0.5A or 9V at 0.3A.



Features

- High efficiency up to 93%
- High power density
- Programmable output voltage (0-105%)
- Programmable output current (0-105%)
- Parallel operation
- Fully featured signals and controls
- 3 year warranty

Applications



Industrial
Electronics &
Robotics



Lasers



LED Heating



Single Phase
Programmable



3D Printing

Dimensions

5.0" x 5.0" x 14.41" (366.0 x 127.0 x 127.0mm)

Models & Ratings

Model Number	Output Voltage V1	Output Current		Efficiency ⁽¹⁾	Ripple & Noise	Output Power
		Min	Max			
HDS3000PS12	12.0VDC	0.0A	250.0A	89%	150mV	3000W
HDS3000PS15	15.0VDC	0.0A	200.0A	90%	150mV	3000W
HDS3000PS24	24.0VDC	0.0A	125.0A	91%	200mV	3000W
HDS3000PS30	30.0VDC	0.0A	100.0A	91%	200mV	3000W
HDS3000PS36	36.0VDC	0.0A	83.5A	92%	200mV	3000W
HDS3000PS48	48.0VDC	0.0A	62.5A	92%	200mV	3000W
HDS3000PS60	60.0VDC	0.0A	50.0A	93%	300mV	3000W

Notes:

1. Measured with 230VAC input and full load.

Input

Characteristic	Minimum	Typical	Maximum	Units	Notes & Conditions
Input Voltage	90		264	VAC	See derating curve
Input Frequency	47		63	Hz	
Power Factor		0.99/0.98			115/230VAC Full load
Input Current			36/18	A	115/230VAC
Inrush Current			60/90	A	115/230VAC
Earth Leakage Current			2.5	mA	264VAC/60Hz
Input Protection	2 x F20A/250V internal fuse				

Output

Characteristic	Minimum	Typical	Maximum	Units	Notes & Conditions
Output Voltage	12		60	VDC	See Models & Ratings table
Output Trim		±5.0		%	By potentiometer
Output Voltage Program	0		105	%	Of rated output
Output Current Program	0		105	%	Of rated output
Voltage Tolerance ⁽¹⁾			±1	%	
Current Tolerance ⁽¹⁾			±2		Of rated output ⁽¹⁾
Minimum Load	0		±3	%	Of rated output ⁽¹⁾
Start Up Delay			2	s	
Start Up Rise Time			150	ms	At full load
Hold Up Time	8			ms	
Line Regulation			±1	%	
Load Regulation			±1	%	V1, 0-100% load
			±3	%	5V standby, 0-100% load
Transient Response			1	%	For a 25% step load change
Ripple & Noise	150		300	mV pk-pk	1.25% for 12V model. Measured with 20MHz bandwidth and using 12" twisted pair wire terminated with 0.1µF ceramic capacitor and 47µF electrolytic.
Overvoltage Protection	Tracks output voltage. See application notes, recycle AC to reset				
Overtemperature Protection	Primary and secondary heatsinks monitored. Output shuts down, auto recovers				
Overload Protection		105		%	Rated power, constant current
Short Circuit Protection	Auto recovery				
Temperature Coefficient		±0.02		%/°C	0-50°C
Remote Sense	Compensates for 0.5V max voltage drop If remote sense is not required, local sense must be used				
Enable	Output must be enabled. See application notes, power supply is shipped with enable links fitted				
Current Share	5 supplies can share within 5%				
Standby Output	5V at 0.5A, present whenever AC is applied (9V at 0.3A, user selectable, by connecting 'VSET', Pin 8 of CN2 to 'GND')				

Notes:

1. Tolerance includes setup time tolerance, line regulation and load regulation.

Output

Output Voltage Programming

Via External Voltage

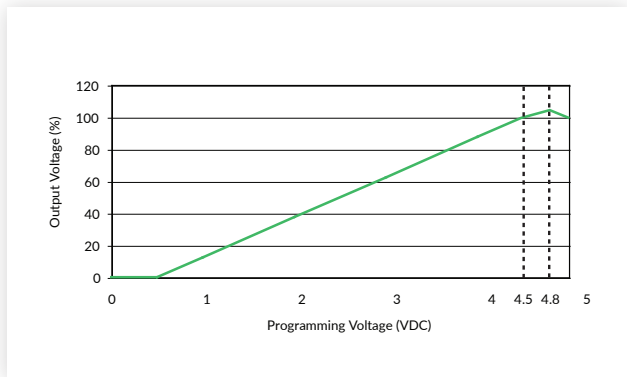

Via External Resistor

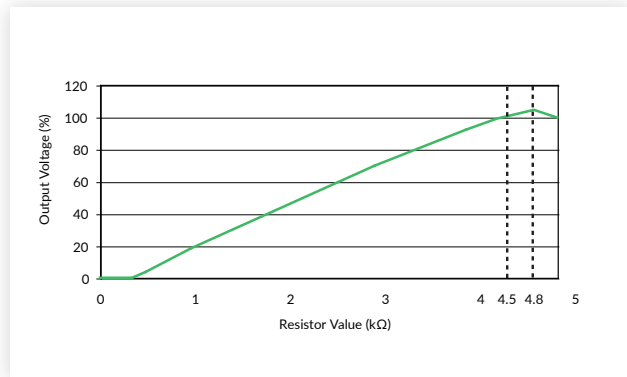

Output Current Programming

Via External Voltage

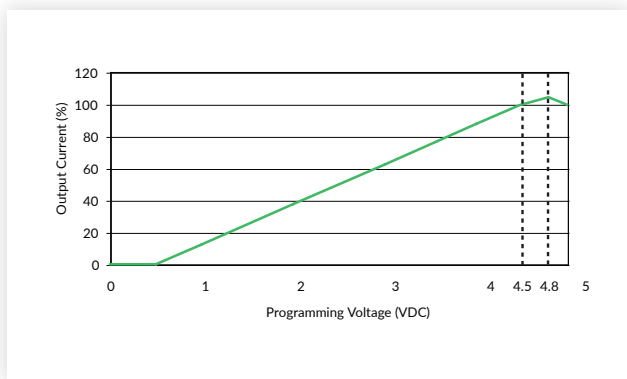

Via External Resistor

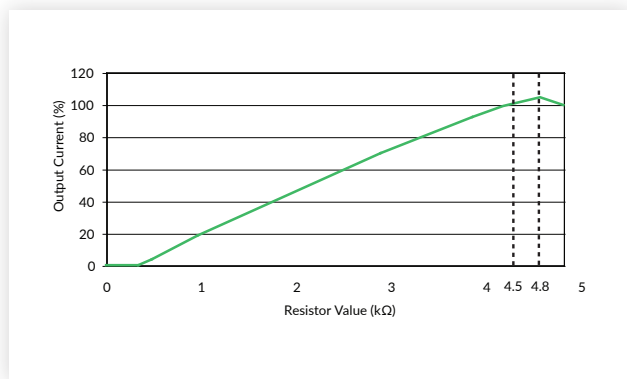

General

Characteristic	Minimum	Typical	Maximum	Units	Notes & Conditions
Efficiency	89		93	%	See Models and Ratings
Isolation: Input to Output	3000			VAC	
Input to Ground	1500			VAC	
Output to Ground	500			VAC	
Switching Frequency	40	65	200	kHz	PFC converter
					PWM, variable
Power Density			8.1	W/in ³	
Signals and Controls					Enable, Current Share, V Program, I Program, 5V Standby, Power OK
Mean Time Between Failure		90		khrs	MIL-HDBK-217F, Notice 2 25°C GB
Weight		11.57 (5.25)		lb (kg)	

Environmental

Characteristic	Minimum	Typical	Maximum	Units	Notes & Conditions
Operating Temperature	-25		+60	°C	Derate linearly from 100% load at 50°C to 60% load at 60°C
Storage Temperature	-40		+85	°C	
Cooling	Internal fan fitted, speed increases with load and internal temperature				
Humidity	20		90	%RH	
Vibration			2	g	10-500 Hz, 10 min/cycle, 60 min period for each axis, compliant to IEC68-2-6, IEC 68-2-64

Derating Curve

Thermal Derating Curve

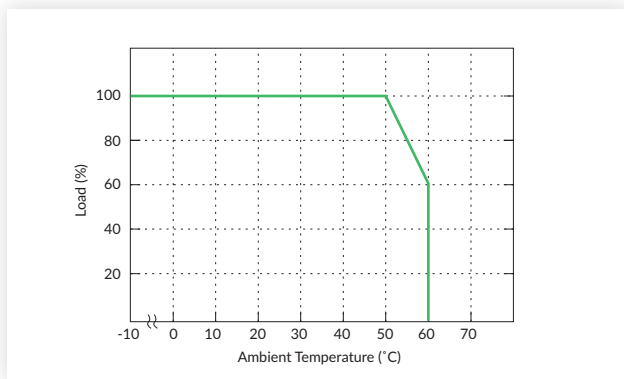

Input Derating Curve

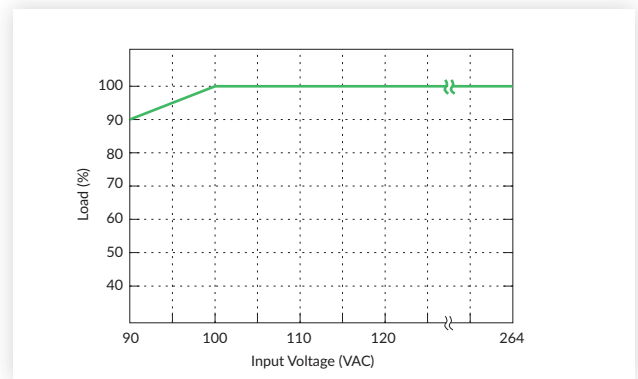

External Programming Voltage Connection

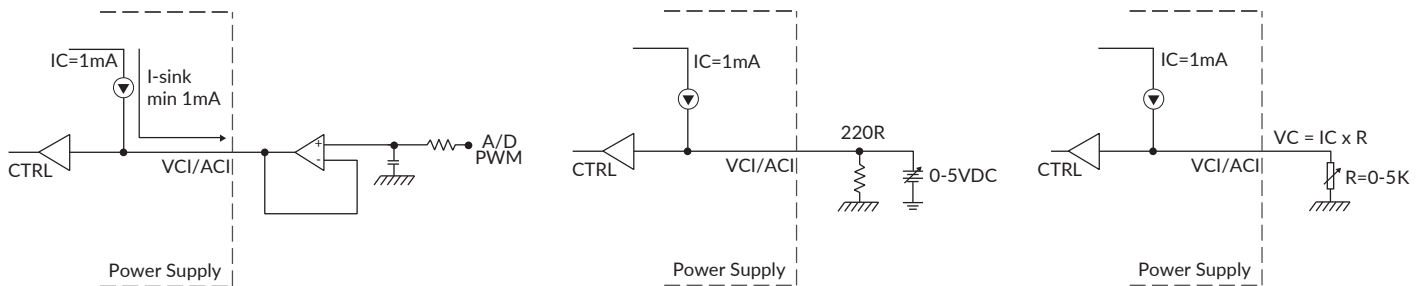

Signals & Controls

LED Status	Output Status
Solid (Green)	DC Output OK
Solid (Orange)	DC Output OK in remote control mode
Slow Blink (Green)	Output Not Enabled
Slow Blink (Orange)	Output Not Enabled in remote control mode
Fast Blink (Red)	Over Voltage
Solid (Red)	Over Loaded
Slow Blink (Red)	Over Temperature
Intermittent Blink (Red)	Fan Fail
Short & Long Blink (Red)	AUX Standby Failure

Remote Enable

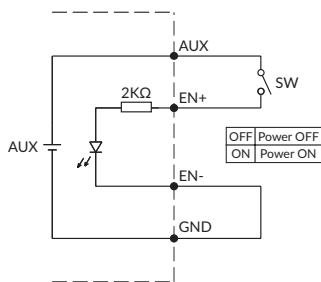

(A) Using internal 5 V standby

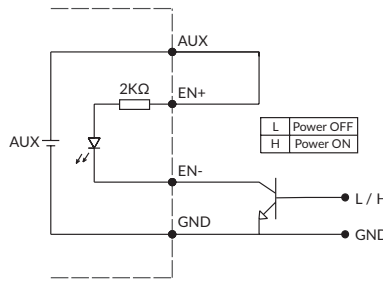

(B) Using external transistor

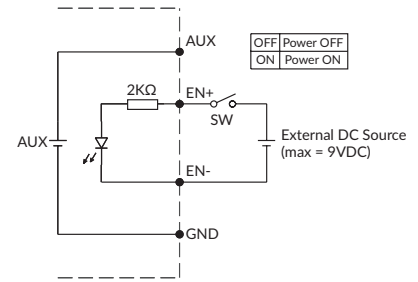

(C) Using external voltage source

*GND shown in above diagram is referring to the GND of CN2, not the grounding from output power (NEG (-))

EMC: Emissions

Phenomenon	Standard	Test Level	Notes & Conditions
Conducted	EN55032	Class A	
Radiated	EN55032	Class A	
Harmonic Currents	EN61000-3-2	Class A	
Voltage Flicker	EN61000-3-3		

EMC: Immunity

Phenomenon	Standard	Test Level	Criteria	Notes & Conditions
ESD Immunity	EN61000-4-2	2/3	A	±4kV contact, ±8kV air discharge
Radiated	EN61000-4-3	3	A	
EFT/Burst	EN61000-4-4	3	A	10V/m
Surges	EN61000-4-5	Installation class 3	A	
Conducted	EN61000-4-6	3	A	10V/m
Magnetic Field	EN61000-4-8	3	A	30A/m
Dips and Interruptions	EN55035	Dip 30% 500ms	A/B	High line/Low line
		Int >95% 10ms	A	
		Int >95% 5000ms	B	

Safety Approvals

Certification	Standard	Notes & Conditions
CB	IEC62368-1	Information Technology
UL	UL62368-1, CSA C22.2 No 62368-1-14	
TUV	EN62368-1	
CE	Meets all applicable directives	
UKCA	Meets all applicable legislation	

Application Notes

POK Signal

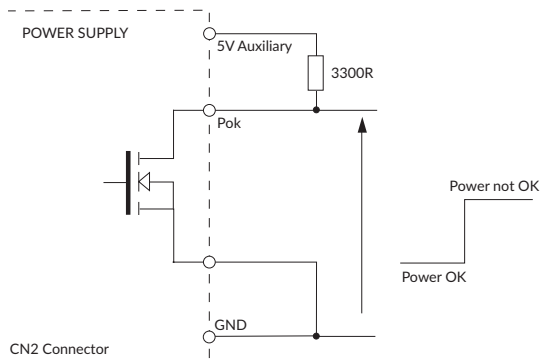

Open drain signal, low when PSU turns on
 Maximum sink current: 20mA
 Maximum drain voltage: 40V

OVP Setting

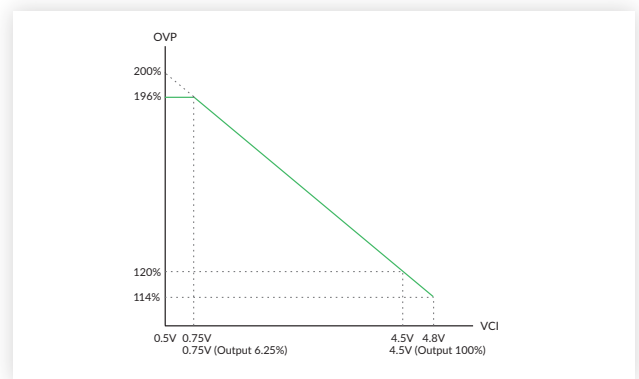

Application Notes

Remote Sense

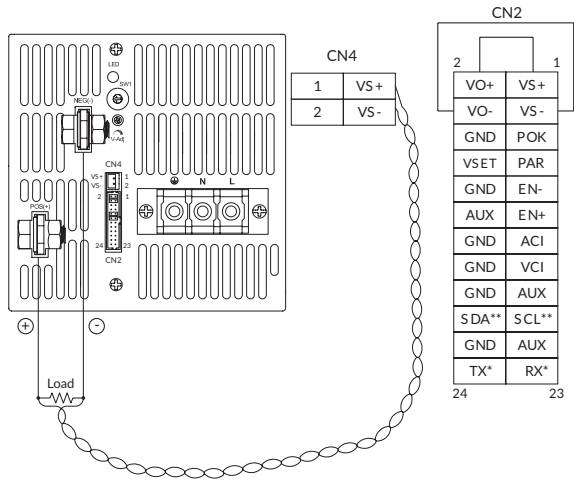

Current Share with Remote Sensing

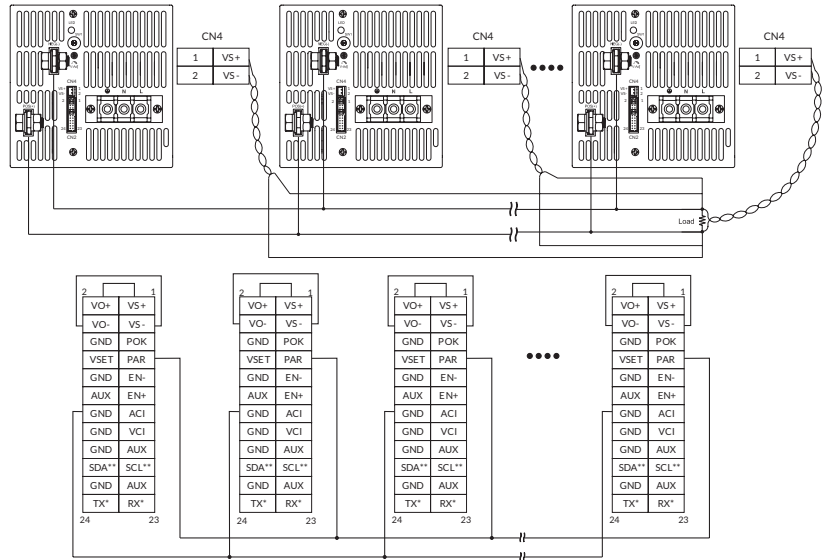

Local Sense

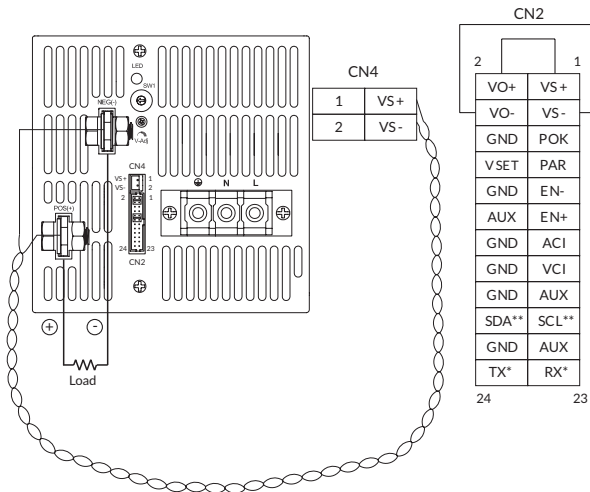

Current Share with Local Sensing

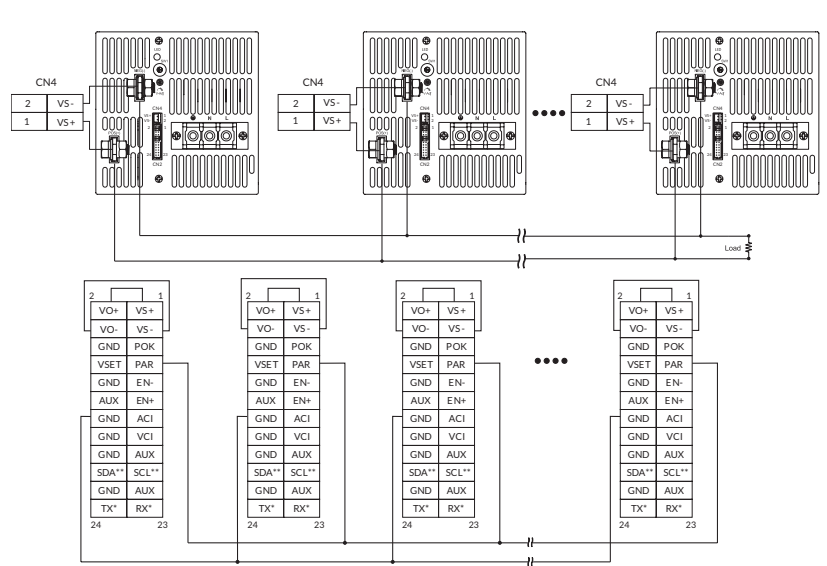

Must be used if remote sense is not required.

Notes:

In parallel operation, it is possible that only one unit will operate if the load is less than 5% of the combined rated output load. *Pin 23 and 24, only usable with driver board "KIT-RS232-X" or "KIT-RS485-1". **If units are connected in parallel, and the I²C bus is used on each of them, then each I²C bus must be isolated to the others.

Mechanical Details

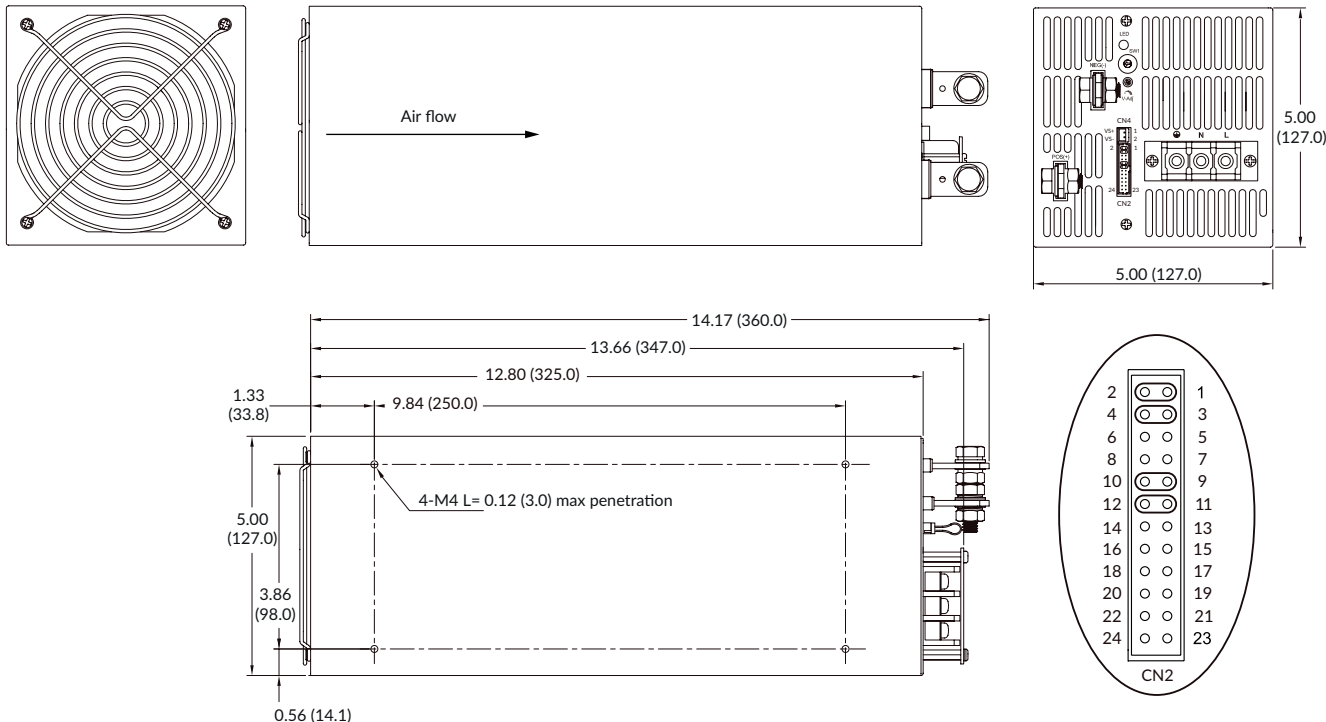

Pin	Function
1	ACL
2	ACN
3	

CN4 Control Pin Connections	
Pin	Function
1	+VS
2	-VS

CN2 Control Pin Connections								
Pin	Function	Description	Pin	Function	Description	Pin	Function	Description
1	VS+	Remote Sense (+)	9	EN-	Inhibit On/Off (-)	17	AUX	+5V/0.5A or +9V/0.3A Standby power
2	VO+	Positive Output Voltage	10	GND	Ground	18	GND	Ground
3	VS-	Remote Sense (-)	11	EN+	Inhibit On/Off (+)	19	SCL**	I ² C Serial Clock
4	VO-	Negative Output Voltage	12	AUX	+5V/0.5A or +9V/0.3A Standby power	20	SDA**	I ² C Serial Data
5	POK	Power OK	13	ACI	I Program	21	AUX	+5V/0.5A or +9V/0.3A Auxiliary power
6	GND	Ground	14	GND	Ground	22	GND	Ground
7	PAR	Parallel Operation Current Share	15	VCI	V Program	23	RX*	Receive
8	VSET	AUX Output Setting	16	GND	Ground	24	TX*	Transmit

Notes:

- Dimensions shown in inches (mm).
- Weight: 11.57 lb (5.25 kg)
- Mating Connector: CN2 JST PHDR-24VS Housing, SPHD-002T-P0.5 Contact
- Mating connector : CN4 JST XHP-2 Housing SXH-001T-P0.6 Contact

*Only usable with driver board "KIT-RS232-X" or "KIT-RS485-1".

**If units are connected in parallel, and the I2C bus is used on each of them, then each I2C bus must be isolated to the others.