

## T111B905K015AS

Aliases (T111B905K015AS{Bulk})

T111, Tantalum, MnO2 Tantalum, Commercial Grade, 9 uF, 10%, 15 VDC

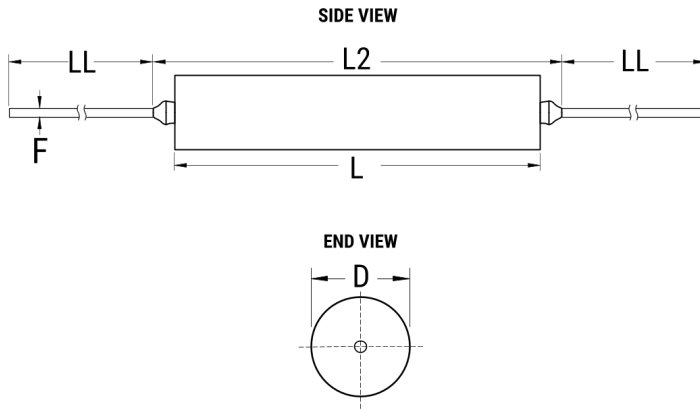

Click [here](#) for the 3D model.

### Dimensions

D	5.26mm +0.25/-0.38mm
L	24.26mm +/-0.79mm
L2	28.7mm
LL	38.1mm +/-6.35mm
F	0.51mm +/-0.05mm

### Packaging Specifications

Packaging	Bulk, Bag
Packaging Quantity	30

### General Information

Series	T111
Dielectric	MnO2 Tantalum
Style	Axial Hermetic
Description	Axial, Solid Tantalum, Hermetically Sealed, Military (Non-ER), Non-Polar
Features	BiPolar, Low Leakage, Low DF
RoHS	No
Prop 65	<b>⚠ WARNING:</b> Cancer and reproductive harm - <a href="http://www.p65warnings.ca.gov">http://www.p65warnings.ca.gov</a> .
SCIP Number	be146961-2c72-4b45-804a-c62bf7a8b23e
Termination	Lead (SnPb)
Lead	Wire Leads
AEC-Q200	No
Construction	Hermetic
Notes	Dimensions Include Insulation Sleeve. When Supplied On T&R Or Ammo, Lead Length Is Determined By Taping Specification.

### Specifications

Capacitance	9 uF
Capacitance Tolerance	10%
Voltage DC	15 VDC (85C), 12 VDC (125C Surge), 10 VDC (125C Reverse)
Temperature Range	-55/+125°C
Rated Temperature	85°C
Dissipation Factor	6%
Leakage Current	2 uA (25°C)