

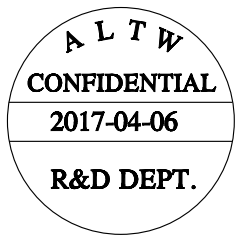

REV.	ECN NO.	DATE	SIGN	DESCRIPTION
B	LEN1580211~222	2015/08/10	Feng_Li	Add Black PVC Cable
C	LEN1680889~906	2016/08/10	Yulong_wang	Add 6Pin & IP69K.
D	LEN1750126~29	2017/04/06	Lingpeng	Change The Cable OD

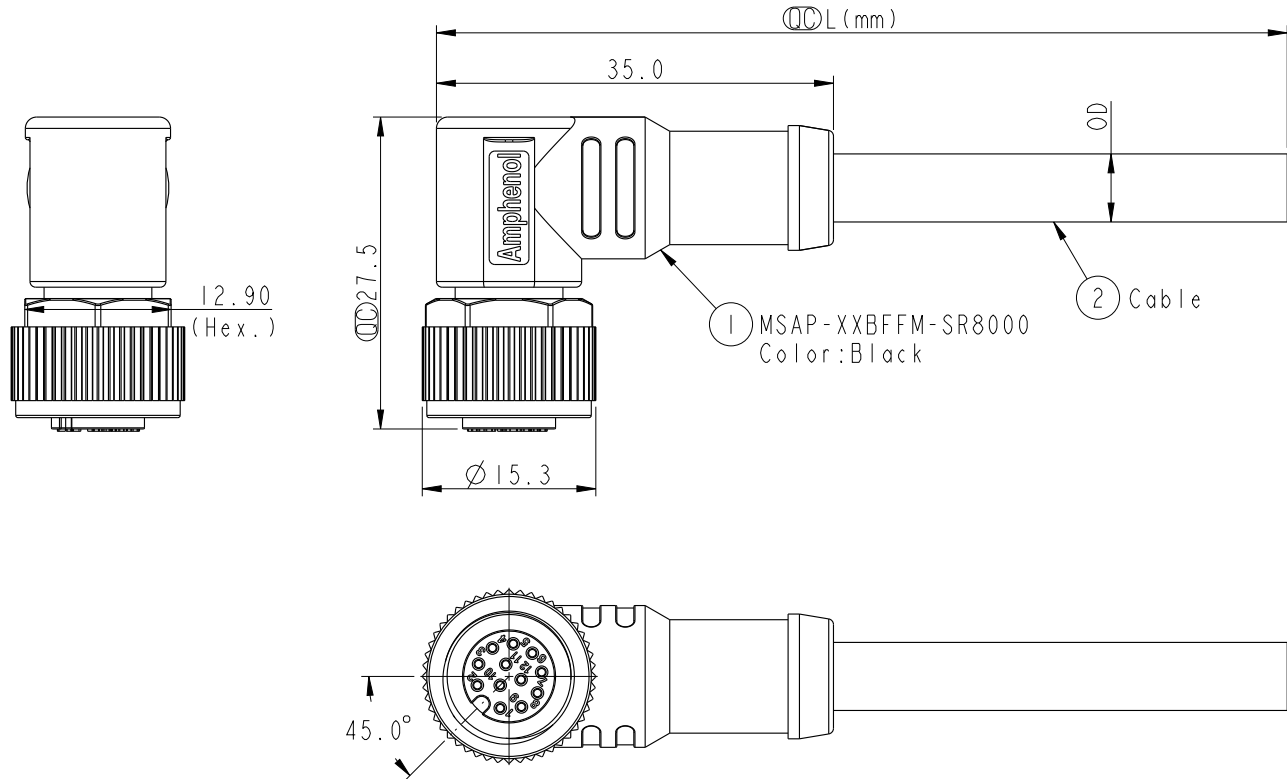

- Notes:
- \*  $\varnothing$  Important Dimension.
  - \* Waterproof Rate: IP68, IP69K.
  - \* Connector: PU+GF, Black.
  - \* Female Pin: Copper Alloy, Gold Plated.
  - \* Screw Nut: Nylon, Black.
  - \* Outer Mold: PU, Black.
  - \* Cable: (A) UL2517, PVC Jacket, Yellow.  
(B) UL20549, PUR Jacket, Black.  
(D) UL2517, PVC Jacket, Black.
  - \* Rated Voltage: 3 & 4Pin 250V dc. or ac.  
5Pin 60V dc. or ac.  
6~12Pin 30V dc. or ac.
  - \* Rated Current: 3~5Pin 4A  
6~8Pin 2A  
10~12Pin 1.5A
  - \* Operating Temperature: -25~85°C
  - \* Cable Length Tolerance: 01M: ±40mm  
02M~05M: ±60mm  
06M~10M: ±100mm  
11M~30M: ±200mm  
31M~99M: ±500mm

UNIT: mm    
TOLERANCE  
±0.5mm

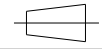
TITLE M12 A Type 90° Female Conn.			
SCALE 3:2	SIZE A4	SHEET 1 OF 3	
REV. D	WC-REV. A.3	$\varnothing$ : Inspection item	

**Amphenol LTW**  
安費諾亮泰企業股份有限公司

ITEM NO	DRAWN BY Lingpeng	DATE 2017-04-06
DWG NO MSAP-XXBFFM-SR8XXX	CHECKED BY Ma Fei	DATE 2017-04-06
CUSTOMER ALTW	APPROVED BY Jerry	DATE 2017-04-06

THIS DOCUMENT IS SUBJECT TO CHANGE WITHOUT NOTICE. IT IS CONFIDENTIAL AND A PROPERTY OF Amphenol LTW. DISCLOSURE TO THIRD PARTY HAS TO BE AUTHORIZED BY Amphenol LTW.

THIS DOCUMENT IS SUBJECT TO CHANGE WITHOUT NOTICE. IT IS CONFIDENTIAL AND A PROPERTY OF Amphenol LTW. DISCLOSURE TO THIRD PARTY HAS TO BE AUTHORIZED BY Amphenol LTW.

	1	2	3	4	5	6	7	8										
F						△B	12P	PVC	6.0	26	MSAP-12BFFM-SR8DXX							
							10P				MSAP-10BFFM-SR8DXX							
						△C	8P		PUR	5.5	24	MSAP-08BFFM-SR8DXX						
							6P					MSAP-06BFFM-SR8DXX						
							5P			5.1	22	MSAP-05BFFM-SR8DXX						
							4P					MSAP-04BFFM-SR8DXX						
							3P	4.5		MSAP-03BFFM-SR8DXX								
							E							△D	12P	PUR	6.0	26
									10P					MSAP-10BFFM-SR8BXX				
						△C			8P					PVC	4.8		24	MSAP-08BFFM-SR8BXX
									6P									MSAP-06BFFM-SR8BXX
									5P						4.4		22	MSAP-05BFFM-SR8BXX
4P	MSAP-04BFFM-SR8BXX																	
3P	3.8	MSAP-03BFFM-SR8BXX																
D									△C						12P	PVC	6.0	26
									10P					MSAP-10BFFM-SR8AXX				
						△C			8P					PVC	5.5		24	MSAP-08BFFM-SR8AXX
									6P									MSAP-06BFFM-SR8AXX
									5P						5.1		22	MSAP-05BFFM-SR8AXX
							4P	MSAP-04BFFM-SR8AXX										
							3P	4.5	MSAP-03BFFM-SR8AXX									
							Contacts		Cable Jacket	Cable OD	AWG	Item No.						

M SAP - XX B F F M - S R 8 X XX

SAP: A-Code Plastic Nut

03: 3Pin  
 04: 4Pin  
 05: 5Pin  
 06: 6Pin △C  
 08: 8Pin  
 10: 10Pin  
 12: 12Pin

B: Cable Without S/R(線端無網尾)  
 F: Female Connector(母座)  
 F: Female Pin(母Pin)

XX: 01~99Meters  
 01: 01Meter  
 02: 02Meters  
 :  
 99: 99Meters

△A: PVC UL2517 Cable, Yellow(PVC黃色外被線材)  
 B: PUR UL20549 Cable, Black(PUR黑色外被線材)  
 △B: PVC UL2517 Cable, Black(PVC黑色外被線材)

8: IP68/69K(防水等級6869K) △C  
 R: Right(90°線端)  
 S: Screw(螺紋式)  
 M: Molding Type(射出成型)

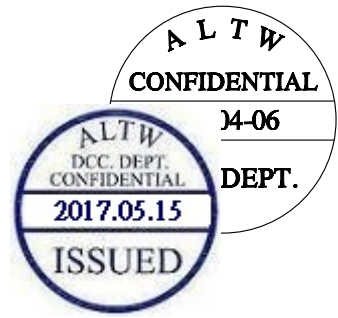

A	UNIT:mm		TITLE	M12 A Type 90° Female Conn.		ITEM NO		DRAWN BY	DATE
	TOLERANCE		SCALE			SIZE	SHEET	DWG NO	CHECKED BY
	±0.5mm		3:2	A4	2 OF 3	MSAP-XXBFFM-SR8XXX	Ma Fei	2017-04-06	
		REV. D	WC-REV. A.3	QC: Inspection item	CUSTOMER		APPROVED BY	DATE	
					ALTW		Jerry	2017-04-06	

**Amphenol LTW**  
 安費諾亮泰企業股份有限公司

THIS DOCUMENT IS SUBJECT TO CHANGE WITHOUT NOTICE. IT IS CONFIDENTIAL AND A PROPERTY OF Amphenol LTW. DISCLOSURE TO THIRD PARTY HAS TO BE AUTHORIZED BY Amphenol LTW.

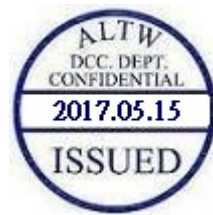
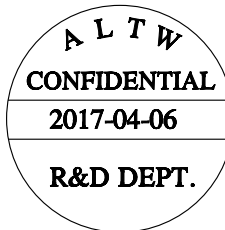

F							
E							
D							

5	--		5	--		5	Gray	灰	5	--		8	--		8	Red	紅	12	--		12	Red/Blue	紅/藍			
4	Black	黑	4	Black	黑	4	Black	黑	4	Black	黑	7	Blue	藍	7	Blue	藍	7	Blue	藍	7	Blue	藍	9	Black	黑
3	Blue	藍	3	Blue	藍	3	Blue	藍	3	Blue	藍	6	Pink	粉	6	Pink	粉	6	Pink	粉	6	Pink	粉	6	Pink	粉
2	--		2	White	白	2	White	白	2	White	白	3	Green	綠	3	Green	綠	3	Green	綠	3	Green	綠	3	Green	綠
1	Brown	棕	1	Brown	棕	1	Brown	棕	1	White	白	1	White	白	1	White	白	1	White	白	1	White	白	1	White	白
Pin #	Wire		Pin #	Wire		Pin #	Wire		Pin #	Wire		Pin #	Wire		Pin #	Wire		Pin #	Wire		Pin #	Wire		Pin #	Wire	

Pin Out

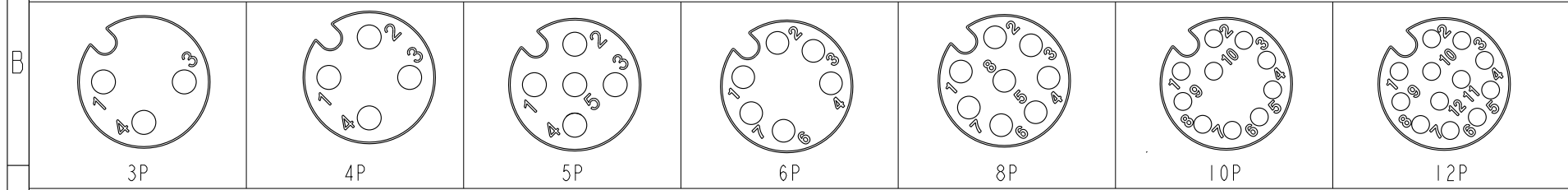

Pin Assignments Front View

A	UNIT:mm		TITLE	M12 A Type 90° Female Conn.		ITEM NO		DRAWN BY	DATE					
	TOLERANCE	±0.5mm	SCALE			3:2	SIZE	A4	SHEET	3 OF 3	DWG NO	MSAP-XXBFFM-SR8XXX	CHECKED BY	Ma Fei
	REV.	D	WC-REV.	A.3	((C)) Inspection item		CUSTOMER	ALTW	APPROVED BY	Jerry	DATE	2017-04-06		

**Amphenol LTW**  
安費諾亮泰企業股份有限公司