

耐食性に優れ、しかも防滴構造 圧力スイッチ PRESSURE SWITCHES

PS85



内部構造図 INTERNAL STRUCTURE (R 1/4)

| 名称 Part name | 材料 Material |
|---------------------------------------|--|
| ① 継手 Fitting | SUS 316L |
| ② ケース Housing | |
| ③ 樹脂カバー Plastic cover | ABS (Acrylonitrile butadiene styrene) + PC (Polycarbonate) |
| ④ ダイアフラム Stainless steel diaphragm | SUS 316L |

■特長 FEATURES

- 高耐食性、防滴構造を実現
圧力受圧部に〈SUS 316L〉
本体に IP-65 (IEC 準拠)
- スイッチ出力 2 点標準装備
- 負圧～正圧まで一台で測定出来る連成圧、絶対圧タイプもラインアップ
- 用途別に継手形状を用意
R2 : R 1/4 (M 5 メネジ付)
GF : G 3/8 (先端ダイアフラムタイプ)
G2 : G 1/4 (M 5 メネジ付)

- High corrosion resistance and drip-proof construction
Pressure port attachment made of SUS 316L
Proven IP-65 grade gauge body (IP-65 in accordance with IEC)
- Standard product provides two switch outputs
- Absolute pressure type and compound pressure type which can control negative to positive pressure with only a single pressure gauge are all in line
- 3 standard types of joint are provided
R2: R 1/4 with M 5 female screw
GF: G 3/8 with flash diaphragm
G2: G 1/4 with M 5 female screw

■型式表示 MODEL NUMBER DESIGNATION

PS85 - 102 R - N1 R2

| | | | | | | | | |
|-------------------------|---|---|-----|---|---|----|----|--|
| シリーズ名 Series name | PS85 | - | 102 | R | - | N1 | R2 | 継手形状 Fitting |
| 指示方式 Pressure reference | 定格圧力 Rated pressure range | | | | | | | R2 : R 1/4 (M 5 メネジ付き) R 1/4 with M 5 female screw GF : G 3/8 (先端ダイアフラム) G 3/8 with flash diaphragm G2 : G 1/4 (M 5 メネジ付き) G 1/4 with M 5 female screw |
| R : 連成圧 Compound | 102 : - 100 ~ 100 kPa 352 : - 100 ~ 350 kPa | | | | | | | |
| A : 絶対圧 Absolute | 103 : - 100 ~ 1000 kPa 102 : 0 ~ 100 kPa abs | | | | | | | |
| | | | | | | | | スイッチ出力方式 Switch output interface |
| | | | | | | | | N1 : NPN 出力 (上限、上限モード) NPN open collector (Upper and upper limit mode) N2 : NPN 出力 (上限、下限モード) NPN open collector (Upper and lower limit mode) P1 : PNP 出力 (上限、上限モード) PNP open collector (Upper and upper limit mode) P2 : PNP 出力 (上限、下限モード) PNP open collector (Upper and lower limit mode) |

※ご注文に際しては、型式一覧表をご確認ください。

Please refer to the LIST OF MODEL NUMBERS when placing orders.

PS85 PRESSURE SWITCHES

■ 型式一覧表 LIST OF MODEL NUMBERS

| 継手 形状 Fitting | 形 (指示方式) Pressure reference | | ゲージ圧 Gauge | | | 絶対圧 Absolute |
|---------------------|--|----------------------------------|----------------|----------------|----------------|-----------------|
| | 出力方式 Switch output | 定格圧力 kPa Rated pressure range | - 100 ~ 100 | - 100 ~ 350 | - 100 ~ 1000 | 0 ~ 100 (abs) |
| R2 (R 1/4) | NPN (上限、上限モード) NPN (Upper and upper limit mode) | | PS85-102R-N1R2 | PS85-352R-N1R2 | PS85-103R-N1R2 | PS85-102A-N1R2 |
| | NPN (上限、下限モード) NPN (Upper and lower limit mode) | | PS85-102R-N2R2 | PS85-352R-N2R2 | PS85-103R-N2R2 | PS85-102A-N2R2 |
| | PNP (上限、上限モード) PNP (Upper and upper limit mode) | | PS85-102R-P1R2 | PS85-352R-P1R2 | PS85-103R-P1R2 | PS85-102A-P1R2 |
| | PNP (上限、下限モード) PNP (Upper and lower limit mode) | | PS85-102R-P2R2 | PS85-352R-P2R2 | PS85-103R-P2R2 | PS85-102A-P2R2 |
| GF (G 3/8) | NPN (上限、上限モード) NPN (Upper and upper limit mode) | | PS85-102R-N1GF | PS85-352R-N1GF | PS85-103R-N1GF | PS85-102A-N1GF |
| | NPN (上限、下限モード) NPN (Upper and lower limit mode) | | PS85-102R-N2GF | PS85-352R-N2GF | PS85-103R-N2GF | PS85-102A-N2GF |
| | PNP (上限、上限モード) PNP (Upper and upper limit mode) | | PS85-102R-P1GF | PS85-352R-P1GF | PS85-103R-P1GF | PS85-102A-P1GF |
| | PNP (上限、下限モード) PNP (Upper and lower limit mode) | | PS85-102R-P2GF | PS85-352R-P2GF | PS85-103R-P2GF | PS85-102A-P2GF |
| G2 (G 1/4) | NPN (上限、上限モード) NPN (Upper and upper limit mode) | | PS85-102R-N1G2 | PS85-352R-N1G2 | PS85-103R-N1G2 | PS85-102A-N1G2 |
| | NPN (上限、下限モード) NPN (Upper and lower limit mode) | | PS85-102R-N2G2 | PS85-352R-N2G2 | PS85-103R-N2G2 | PS85-102A-N2G2 |
| | PNP (上限、上限モード) PNP (Upper and upper limit mode) | | PS85-102R-P1G2 | PS85-352R-P1G2 | PS85-103R-P1G2 | PS85-102A-P1G2 |
| | PNP (上限、下限モード) PNP (Upper and lower limit mode) | | PS85-102R-P2G2 | PS85-352R-P2G2 | PS85-103R-P2G2 | PS85-102A-P2G2 |

※ご注文に際しては、上記型式をご確認ください。
Verify the above model numbers when placing orders.

■ 標準仕様 STANDARD SPECIFICATIONS

● 特記ない場合、周囲温度 25 ± 5 °C、駆動電圧 12 V DC で規定します。
Unless otherwise specified, the specs are defined at an ambient temperature of 25±5 °C and excitation voltage of 12 V DC.

| 項目 Item | 型式 Model number | PS85 | | | |
|---------------------------------------|--------------------|--|-------------|--------------|-----------------|
| | | 102R | 352R | 103R | 102A |
| 形 (指示方式) Pressure reference | | ゲージ圧 Gauge | | | 絶対圧 Absolute |
| 定格圧力 / 定格圧力範囲 Rated pressure range | kPa | - 100 ~ 100 | - 100 ~ 350 | - 100 ~ 1000 | 100 (abs) |
| 最大圧力 Maximum pressure | kPa | 200 | 700 | 2000 | 200 (abs) |
| 破壊圧力 Break-down pressure | kPa | 300 | 1050 | 3000 | 300 (abs) |
| 動作温度 Operating temp. range | °C | - 20 ~ 80 | | | |
| 補償温度 Compensated temp. range | °C | 0 ~ 50 | | | |
| 動作湿度 Operating humidity | %RH | 35 ~ 85 (結露ないこと No condensation) | | | |
| 保存温度 Storage temp. | °C | - 20 ~ 80 (大気圧、湿度 65 %RH 以下 Atmospheric pressure, humidity 65 %RH maximum) | | | |
| 適用媒体 Pressure medium | | SUS 316L を腐食させない気体及び液体 Corrosive gases/liquids compatible with SUS 316L | | | |
| 絶縁抵抗 Insulation resistance | MΩ minimum | 100 (500 V DC) | | | |

PS85

PRESSURE SWITCHES

■標準仕様 STANDARD SPECIFICATIONS

- 特記ない場合、周囲温度 25 ± 5 °C、駆動電圧 12 V DC で規定します。
Unless otherwise specified, the specs are defined at an ambient temperature of 25±5 °C and excitation voltage of 12 V DC.

| 項目 Item | 型式 Model number | PS85 | | | |
|--------------------------------|---|--|--|------|-----------|
| | | 102R | 352R | 103R | 102A |
| 一般仕様 General specifications | 耐電圧 Dielectric strength | 800 V AC, 60 s (リーク電流 1 mA 以下 Leakage current 1 mA maximum) | | | |
| | 封入液 Sealed liquid | シリコンオイル Silicone oil | | | |
| | 圧力ポート Pressure port | R 1/4、G 3/8 (フラッシュダイアフラム Flash diaphragm)、G 1/4 ※ 1 | | | |
| | 質量 Net weight | g | R2 : Approx. 165, GF : Approx. 180, G2 : Approx. 170 | | |
| | 保護構造 Drip-proof structure | IP-65 | | | |
| 電源 Power | 駆動電圧 Supply voltage | V DC | 10.8 ~ 30 (リップル含む Including ripple percentage) | | |
| | 消費電流 Consumption current | maximum | 20 mA | | |
| スイッチ出力 Switch output | 出力点数 No. of outputs | 2 | | | |
| | 出力方式 Output interface | オープンコレクタ (NPN/PNP) Open collector output (NPN or PNP) | | | |
| | 設定方式 Setting method | トリマによる可変式 Adjustable by VR | | | |
| | 設定範囲 Adjustable range | 0 ~ 100 % | | | 0 ~ 108 % |
| | 動作モード Output mode | 上限、上限モード / 上限、下限モード Upper and upper limite mode / Upper and lower limite mode | | | |
| | 出力表示 Display | SW1 : 赤色 LED 点灯、SW2 : 緑色 LED 点灯 SW1 : Red LED ON, SW2 : Green LED ON | | | |
| | 精度 Accuracy (Reference temp.: 25 °C) | 0 ~ 50 °C (基準温度 25 °C) %F.S. | ± 3 | | |
| | 応差 Hysteresis | %F.S. maximum | 2 | | |
| | スイッチ容量 Switching capacity | 30 V DC 100 mA 以下 | | | |
| | 残留電圧 Residual voltage | V | 0.8 (NPN), 1.2 (PNP) | | |
| 応答速度 Response | ms | Approx. 2 | | | |

- ※ 1 ○ リング付属 (G 3/8 : P18、G 1/4 : P15)
An "O" ring is provided as accessory. (G 3/8 : P18, G 1/4 : P15)

■環境特性 ENVIRONMENTAL CHARACTERISTICS

| 試験項目 Test item | 試験方法 (条件 25 ± 5 °C) Test conditions (At 25 ± 5 °C) | 変動量 Permissible change |
|----------------------------|--|---|
| 振動 Vibration | 10 ~ 500 Hz, 1.5 mm maximum/98.1 m/s ² , 3 directions for 2 hours each | スイッチ出力設定値最大 ± 1 %F.S. Switch output setting: ± 1 %F.S. maximum |
| 衝撃 Shock | 490 m/s ² 3 directions for 3 times each | |
| 圧力サイクル Pressure cycling | 定格圧力 / 定格圧力範囲 10 ⁶ cycles Rated pressure range | |
| 耐湿性 Moisture resistance | 40 °C, 90 ~ 95 %RH, 240 hrs. | |

PS85 PRESSURE SWITCHES

外形寸法図 OUTLINE DIMENSIONS

Unless otherwise specified, tolerance : ± 0.5(Unit: mm)

● 継手形状 R2 (R 1/4) タイプ Configurations of joint R2 (R 1/4) type

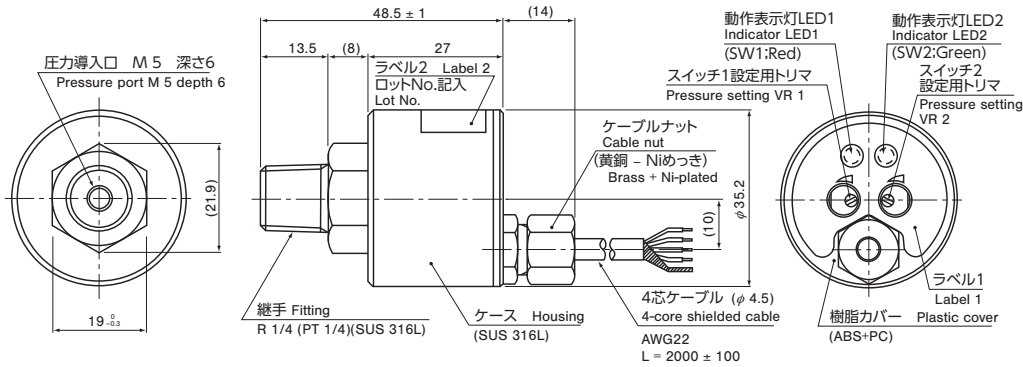

● 継手形状 GF (G 3/8) タイプ Configurations of joint GF (G 3/8) type

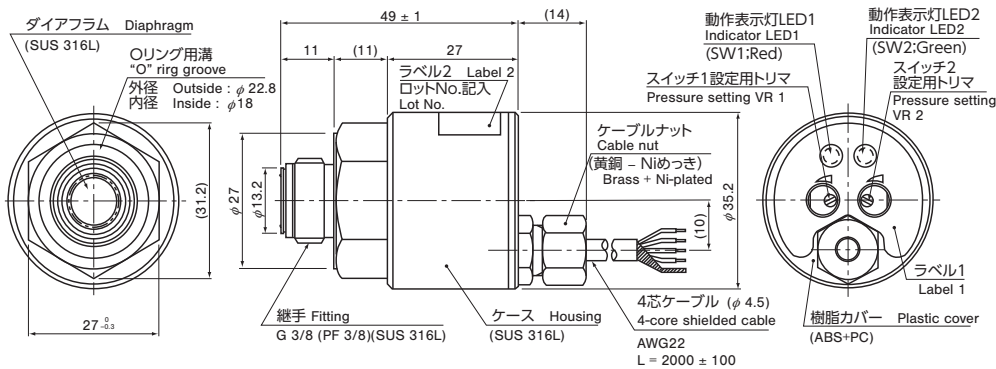

⚠ ステンレスダイアフラム部は、指や個体物等で押したりしますと、ダイアフラム面が変形したり破壊することがありますので、ご注意ください。
Extra care should be taken with the diaphragm part. Do not touch the diaphragm directly to avoid damaging the diaphragm.

● 継手形状 G2 (G 1/4) タイプ Configurations of joint G2 (G 1/4) type

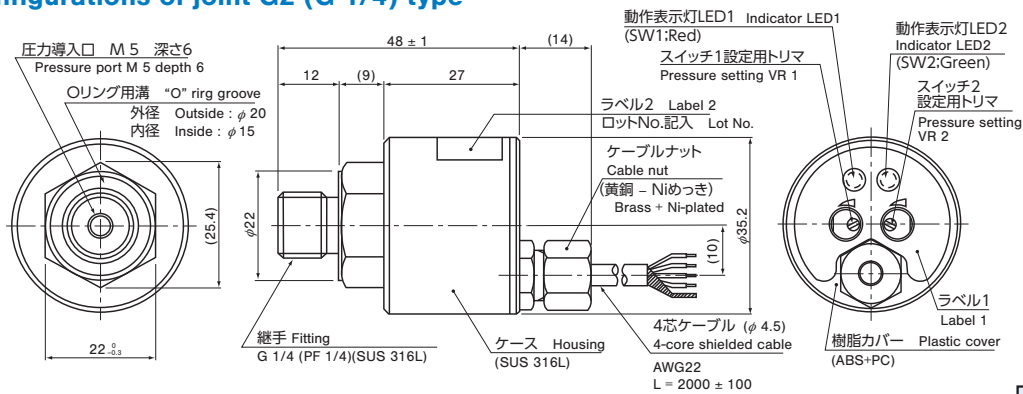

| Wire color | Connection |
|------------|-----------------|
| Brown | Power ⊕ |
| Black | Switch output 1 |
| White | Switch output 2 |
| Blue | Common |
| Shield | Fitting |

PS85 PRESSURE SWITCHES

■スイッチ出力動作 SWITCH OUTPUT SCHEMATICS

● PS85-***R-1**

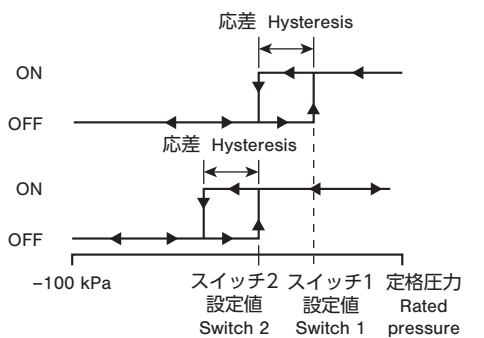

● PS85-102A-1**

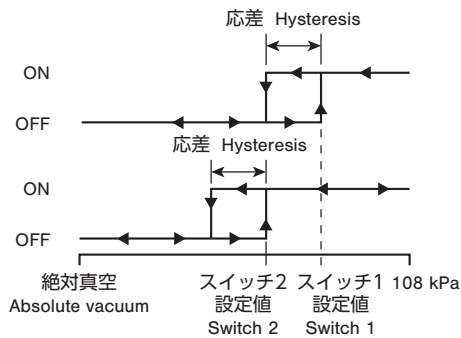

● PS85-***R-2**

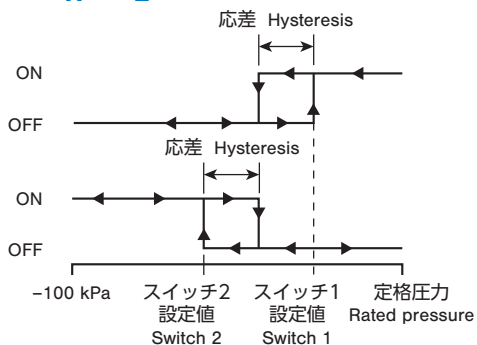

● PS85-102A-2**

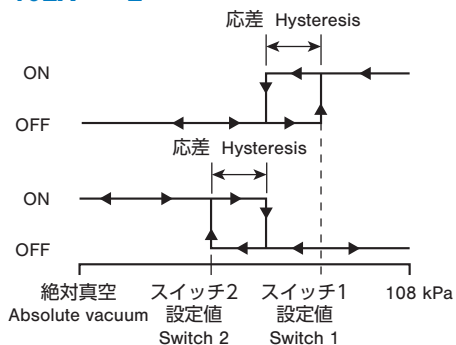

■内部電気回路 INTERNAL ELECTRICAL SCHEMATICS

● NPN

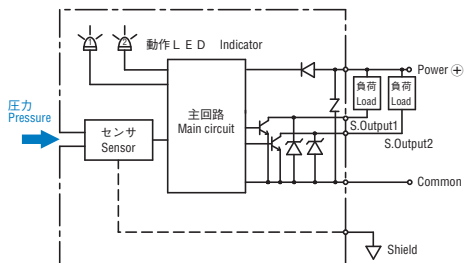

● PNP

